

ASHFIELD LOCAL PLAN REVIEW

ADOPTED NOVEMBER 2002

FOREWORD

The previous Ashfield Local Plan was adopted in December 1995 with a plan period to 2001. Following adoption of the Nottinghamshire Structure Plan Review in November 1996 work commenced on the Ashfield Local Plan Review with a plan period to 2011.

In July 1997 consultation took place on the Main Issues and Site Allocations Report. The Council's response to comments made on the report were subsequently published on 4th March 1999 together with the Ashfield Local Plan Review Deposit Draft.

Following detailed consideration of responses to the Deposit Draft Plan and revised Government guidance, a Second Deposit Local Plan was prepared to include proposed changes to the Deposit Draft Local Plan. The Second Deposit Local Plan was subsequently approved on 11th May 2000 for public consultation.

An Inquiry into unresolved objections to the Ashfield Local Plan Review was held between 13th February and 22nd May 2001. The Inspector considered all of the outstanding objections to the Plan together with a number of informal 'Inquiry Changes' (IC's) that the Council proposed at the time of the Inquiry.

The Inspector's Report on the Local Plan Inquiry was released for public consideration on 16th January 2002. The Council considered all of the Inspector's recommendations, and subsequently the 'Statement of Decisions on the Inspector's Report & Proposed Modifications to the Ashfield Local Plan Review' was published for consultation on 9th May 2002. A report of consultation was published in July 2002 indicating that no further material changes were required to the plan.

The Council resolved on 5th September 2002, to formally adopt the Local Plan in its modified form. The Council publicly advertised its decision to adopt the Plan, on the 22nd November 2002.



Mr. P.K. Johnson, Dip T.P., M.R.T.P.I.
Head of Development Services,
Ashfield District Council,
Council Offices,
Urban Road,
Kirkby-in-Ashfield,
Nottingham,
East Midlands,
NG17 8DA

	Page
HOW TO READ AND USE THIS DOCUMENT	1
GLOSSARY OF TERMS AND ABBREVIATIONS	3
SECTION 1: INTRODUCTION AND STRATEGY	
Chapter 1: INTRODUCTION	
The Development Plan System	11
Policy Context for the Ashfield Local Plan Review	11
Local Plan Review Main Issues Report	12
Form of the Local Plan	12
Departure Procedure	12
Consultation	12
Chapter 2: THE LOCAL PLAN REVIEW STRATEGY	
Introduction	13
Central Government Advice	13
Ashfield District: Background	13
Structure Plan Review	14
Aims and Objectives of the Local Plan	15
Environmental Appraisal	16
Settlement Hierarchy	17
Policy ST1 – DEVELOPMENT	17
General Location of Development	18
Policy ST2 – MAIN URBAN AREAS	20
Policy ST3 – NAMED SETTLEMENTS	21
Policy ST4 – THE REMAINDER OF THE DISTRICT	21
Map A - County Setting	23
Map B - District Setting	24
SECTION 2: LAND USE POLICY AND IMPLEMENTATION	
Chapter 3: THE ENVIRONMENT	
Introduction	25
Central Government Advice	25
Structure Plan Review	26
Other relevant plans and publications	26
Environment Objectives	26
Environment Assessment	27
The Rural Environment -	27
Policy EV1 - GREEN BELT	28
Policy EV2 - THE COUNTRYSIDE	30
Policy EV3 - RE-USE OF BUILDINGS IN THE GREEN BELT AND COUNTRYSIDE	32
Policy EV4 - MATURE LANDSCAPE AREAS	33
Policy EV5 - SITES OF SPECIAL SCIENTIFIC INTEREST AND LOCAL NATURE RESERVES	34
Policy EV6 - SITES OF IMPORTANCE FOR NATURE CONSERVATION AND GEOLOGICAL SIGNIFICANCE	34
Policy EV7 - SITES/BUILDINGS SUPPORTING SPECIES PROTECTED BY LAW	36
Policy EV8 - TREES AND WOODLANDS	36

Hedgerows	37
Greenwood Community Forest	37
Policy EV9 - AGRICULTURAL LAND	38
The Built Environment	38
Policy EV10 - CONSERVATION AREAS	39
Policy EV11 - ANCIENT MONUMENTS AND ARCHAEOLOGICAL SITES	41
Policy EV12 - LISTED BUILDINGS	42
Policy EV13 - SETTING OF LISTED BUILDINGS	43
Policy EV14 - HISTORIC PARKS AND GARDENS	43
Policy EV15 - DERELICT AND CONTAMINATED LAND RECLAMATION	44
Policy EV16 - WATER QUALITY AND FLOOD PROTECTION	45
Policy EV17 - TELECOMMUNICATIONS	46
Minerals Local Plan	47
Waste Local Plan	48
Policy EV18 - RENEWABLE ENERGY	48
Chapter 4: EMPLOYMENT	
Introduction	51
Central Government Advice	51
Structure Plan Review	52
Employment Objectives	52
Employment Land Requirement and Provision	53
Table 4.1: Employment Land Requirements and Provision, 1991-2011	53
Policy EM1 - EMPLOYMENT LAND ALLOCATIONS	54
Employment Sites with Planning Permission	55
Sherwood Business Park	55
Employment Sites without Planning Permission	55
Summary of Employment Land Allocations	56
Road Related Development	59
Appropriate Uses and Hazardous and Pollutant Industries	59
Development in the vicinity of Rolls Royce, Hucknall	59
Policy EM2 - OPEN AIR TESTING ZONE AT ROLLS ROYCE	60
Policy EM3 - OTHER EMPLOYMENT DEVELOPMENT IN THE MAIN URBAN AREAS AND NAMED SETTLEMENTS	60
Employment Development in Rural Areas	60
Policy EM4 - PROTECTION OF EMPLOYMENT LAND ALLOCATIONS	61
Policy EM5 - PROTECTION OF EXISTING EMPLOYMENT SITES AND BUILDINGS	61
SITE CONSIDERATION DEVELOPMENT	62
Policy EM6 - EMPLOYMENT DEVELOPMENT	62
Policy EM7 - BUSINESSES IN RESIDENTIAL AREAS AND PROPERTIES	63
Chapter 5: HOUSING	
Introduction	65
Central Government Advice	65
Structure Plan Review	65
Housing Objectives	66
Housing Land Requirement	66
Table 5.1 Dwelling Requirement and Provisions 1991-2011	66
Housing Land Supply	67

Housing Location Strategy: A Sequential Approach	67
Policy HG1 - HOUSING LAND ALLOCATIONS	68
Housing Sites with planning permission	69
Housing Sites without planning permission	70
Housing Development Contributions to other facilities	70
Summary of Housing Allocations	70
Policy HG2 - OTHER RESIDENTIAL DEVELOPMENT IN THE MAIN URBAN AREA(S) AND NAMED SETTLEMENTS	75
Policy HG3 - HOUSING DENSITY	75
Policy HG4 - AFFORDABLE HOUSING	76
SITE CONSIDERATION POLICIES	79
Policy HG5 - NEW RESIDENTIAL DEVELOPMENT	79
Residential Caravans and Mobile Homes	80
Policy HG6 - PUBLIC OPEN SPACE IN NEW RESIDENTIAL DEVELOPMENTS	80
Policy HG7 - RESIDENTIAL EXTENSIONS	81
Policy HG8 - RESIDENTIAL CARE FACILITIES, HOUSES IN MULTIPLE OCCUPATION BEDSITS, FLATS AND HOSTELS	81
Policy HG9 - GYPSY CARAVAN SITES AND SITES FOR TRAVELLING SHOW PEOPLE	82
Chapter 6: TRANSPORTATION	
Introduction	83
Central Government Advice	83
Structure Plan Review	83
Transport Objectives	84
Public Transport	84
Policy TR1 - NOTTINGHAM EXPRESS TRANSIT	85
Cycling	85
Policy TR2 - CYCLING PROVISION IN NEW DEVELOPMENTS	86
Policy TR3 - PEDESTRIANS AND PEOPLE WITH LIMITED MOBILITY	86
Policy TR4 - PEDESTRIAN PRIORITY SCHEMES	87
Policy TR5 - COUNTY COUNCIL HIGHWAY SCHEMES	87
Policy TR6 - DEVELOPER CONTRIBUTIONS TO TRANSPORT IMPROVEMENTS	89
Car Parking	91
Chapter 7: SHOPPING	
Introduction	93
Central Government Advice	93
Structure Plan Review	93
Shopping Objectives	93
Policy SH1 - DISTRICT SHOPPING CENTRES	94
The Need for New Retail Development	95
Table 7.1 Potential for Additional Retail Floorspace 1997-2011	96
Policy SH2 - RETAIL DEVELOPMENT SITES	96
Policy SH3 - RETAILING OUTSIDE DISTRICT SHOPPING CENTRES	98
Policy SH4 - LOCAL SHOPPING CENTRES	99
Policy SH5 - MINOR SHOPPING CENTRES AND SINGLE SHOPS	100
Policy SH6 - FACTORY SHOPS	101
Policy SH7 - FARM SHOPS	101

SITE CONSIDERATION POLICIES	101
Policy SH8 - COMMERCIAL/RETAIL DEVELOPMENT	101
Policy SH9 - HOT FOOD SHOPS	102
Policy SH10 - SPECIAL DEVELOPMENT SITE: KINGSMILL ROAD EAST/MANSFIELD ROAD SUTTON-IN-ASHFIELD	103
Chapter 8: RECREATION, TOURISM AND COMMUNITY SERVICES	
Introduction	105
Central Government Guidance	105
Structure Plan Review	105
Recreation, Tourism and Community Services Objectives	106
Open Space	106
Table 8.1 Summary of Open Space Provision in Ashfield	106
Country Parks outside Main Urban Areas and Named Settlements	106
Policy RC1 - NEW INFORMAL OPEN SPACE	107
Policy RC2 - OPEN AREAS IN MAIN URBAN AREAS AND NAMED SETTLEMENTS	108
Policy RC3 - FORMAL OPEN SPACE	109
Outdoor Playing Space Assessment	113
Table 8.2 Outdoor Playing Space in Ashfield: Current Requirements at 1997	113
Table 8.3 Outdoor Playing Space in Ashfield: Projected Requirements to 2011	114
Policy RC4 - NEW FORMAL OPEN SPACE	114
Table 8.4 Non Site Specific New Open Space Requirements on Residents Sites in Policy HG1	115
Table 8.5 Comparison of Outdoor Playing Space deficit and provision to 2011	115
Playing Pitch Assessment	115
Policy RC5 - ALLOTMENTS	116
Cemeteries	117
Policy RC6 - INDOOR LEISURE FACILITIES	118
Policy RC7 – INDOOR LEISURE FACILITIES OUTSIDE DISTRICT SHOPPING CENTRES	118
Policy RC8 - RECREATION ROUTES	119
Specialist Pursuits	119
Tourism	120
Policy RC9 - COMMUNITY SERVICES	120
Chapter 9: IMPLEMENTATION	
Introduction	123
Development Control Policies	123
Promotional Policies	123
Policy Implementation Matrix	124
Table 9.1 Ashfield Local Plan Review: Policy Implementation Matrix	124
SECTION 3: APPENDICES	
Appendix 1: List of SINC's	125
Appendix 2: List of Ancient Woodland Sites	129
Appendix 3: List of Buildings of Special Architectural or Historic Interest	131
Appendix 4: Employment Site Briefs	133
Appendix 5: Housing Land Allocations	139
Appendix 6: Housing Site Briefs	143
Appendix 7: Parking Standards for New Developments	149
Appendix 8: Special Development Site Brief	175

HOW TO READ AND USE THIS DOCUMENT

The Ashfield Local Plan Review is intended as a comprehensive document covering all aspects of planning policy within the District.

It is important to read the whole document to understand all the policies and guidance which will apply to any proposal. In many cases the wording of policies excludes aspects relating to the detailed site considerations pertaining to a proposal as these are covered separately, initially by Policy ST1 and at the end of relevant chapters under the heading 'Site Consideration Policies'. The wording of each policy has therefore been simplified to avoid repetitive detailed development control requirements.

The document is divided into three sections:-

Section 1: Introduction and Strategy (Chapters 1 and 2): This section outlines the need for the Local Plan and its strategic background. The strategy chapter indicates the aims of the plan. It includes an overall policy relating to any development and covers the general attitude towards development in different parts of the District.

Section 2: Land Use Policy and Implementation (Chapters 3-9): This section considers land needs for specific uses and identifies sites for development or protection. The Proposals Map identifies in detail the location of sites on a policy by policy basis. In certain chapters, site consideration policies contain detailed development control policies against which individual applications will be considered. Chapter 9 contains information about the various agencies involved in the implementation of land use policies and proposals. Specific requirements for the development of employment and housing sites in policies EM1 and HG1 are shown in both the supporting text to these policies and the site briefs in Appendix Four and Six respectively.

Section 3: Appendices: These contain further information or background to a number of policies in Section 2.

Section 1 Introduction and Strategy	Section 2 Land Use Policy and Implementation	Section 3 Appendices
Provides an overall policy approach to development and identifies the general areas most appropriate for development	Identifies appropriate sites for development and policies to control development on those sites	Background information relating to some policies in Section 2 including site development briefs

Policy numbering:

Policy numbers in the respective chapters are numbered consecutively and prefixed by the following chapter abbreviations:-

ST	Strategy	TR	Transport
EV	Environment	SH	Shopping
EM	Employment	RC	Recreation
HG	Housing		

Where land related policies require the identification of a specific site, the policy number is followed by a CAPITAL letter identifying the general location of the site in accordance with the overall strategy of the document, as follows:-

Main Urban Area of Hucknall	H
Main Urban Area of Kirkby-in-Ashfield	K
Main Urban Area of Sutton-in-Ashfield	S
Named Settlements of Jacksdale, Selston, Underwood, New Annesley, Brinsley and Bestwood Village	N
The remainder of the District (Rural Areas)	R

Each specific site within the areas above is then allocated a lower case letter in alphabetical order.

GLOSSARY OF TERMS AND ABBREVIATIONS

Adverse Affect: Weighing all material considerations to determine whether the proposed development would cause demonstrable harm to interests of acknowledged importance.

Affordable Housing: Dwellings developed specifically for those whose incomes generally deny them the opportunity to purchase or rent houses on the open market. Can refer to dwellings for owner occupation, on either a wholly owned or shared ownership basis, at the lower cost end of the market or housing for rent. See Circular 6/98.

Agriculture: Defined by Section 336(1) of the Town and Country Planning Act 1990 as including: horticulture, fruit growing, seed growing, dairy farming, the breeding and keeping of livestock (including any creature kept for the production of food, wool, skins or furs, or the purpose of its use in the farming of land), the use of land as grazing land, meadow land, osier land, market gardens and nursery grounds, and the use of land for woodlands where that use is ancillary to the farming of land for other agricultural purposes.

Allocation: Land identified in a Local Plan as appropriate for a specific land use.

Ancient Monument: A structure regarded by the Secretary of State for the Environment, Transport and the Regions as being of national importance by virtue of its historic, architectural, traditional or archaeological interest. Scheduled Ancient Monuments are listed in a schedule compiled under the requirements of Section 1 of the Ancient Monuments and Archaeological Areas Act, 1979.

Ancillary Use: A use which is secondary to, but associated with, the main use, e.g. car parking secondary to a use as a retail store.

Ashfield Local Plan: The District Wide Local Plan for Ashfield, adopted in December 1995 with an end date of 2001.

Bagthorpe: A loosely knit village which includes Bagthorpe itself, Lower Bagthorpe, Middlebrook and New Bagthorpe.

Biodiversity: The range of life forms which constitute the living world, from microscopic organisms to the largest tree or animal, and the habitat and ecosystem in which they live.

Brierley Forest Park: Former colliery spoilheap and adjacent land which has been reclaimed to create a substantial area of public open space incorporating extensive multi-user paths, pond and wetlands and woodland.

Brownfield: A general term used to describe previously developed land or buildings.

Built Environment: Those parts of the District which are primarily built-up, including all settlements, buildings and other structures.

Bulky Goods Retailing: Retailing of principally large durable goods requiring transfer from store to car or larger vehicle in order to be taken away and comprising: Furniture, carpets and floor coverings, electrical goods, gas appliances, DIY maintenance and improvement products for the home, garden and motor vehicles and ancillary goods.

Census of Population: A survey of the entire population of the United Kingdom, undertaken on a ten-yearly basis.

Circular: A government publication providing guidance on specific issues. Identified by the number and the year in which it was published.

CISWO: Coal Industry Social Welfare Organisation.

Commercial Development: In town centres includes built leisure facilities, bingo halls, cinemas, snooker halls, clubs, pubs, restaurants, petrol filling stations, offices and financial services.

Commitment: Land with an unexpired planning permission.

Commuted Sum: One-off payment made instead of providing facilities or a service, and which takes away responsibility to make such provision.

Comparison Goods: A term used in retailing to indicate goods purchased for longer term use and likely to be subject to "comparison" between suppliers before purchase. Includes clothing, footwear, household goods, books, stationery, chemist goods, photographic goods, jewellery, leather, sports goods, cycles and prams.

Conservation Area: An area designated by a Local Planning Authority under Section 69 of the Planning (Listed Buildings and Conservation Areas) Act, 1990, regarded as being an area of special architectural or historic interest the character or appearance of which is desirable to preserve or enhance.

Convenience Goods: A term used in retailing to indicate goods purchased for regular consumption. Includes food, groceries, drink, confectionery, tobacco and newsprint.

Countryside: The rural parts of the District lying outside the defined Main Urban Areas and Named Settlements excluding, for the purposes of this Local Plan, land designated as Green Belt.

Density: The intensity of development in a given area. Usually measured, for housing, in terms of number of dwellings per hectare. Net residential density is measured as the number of dwelling units per hectare of land developed specifically for housing and directly associated uses. This includes access roads within the site, private garden space, car parking and incidental open space/landscaping.

Department of Culture Media and Sport (DCMS): The Government Department responsible for matters related to the historic built environment including listed buildings.

Department of Environment, Transport and the Regions (DETR): The Government Department responsible for legislation on planning and other matters related to the environment, policy advice on a range of transport issues and overseeing the motorway and trunk road network.

Derelict Land: There is no statutory definition of derelict land, but it is defined administratively as "land so damaged by industrial or other development that it is incapable of beneficial use without treatment".

DEVELOPMENT:-

Small Scale: Refers to the amount of development on a particular site. Usually measured in numbers of dwellings or industrial units. The degree of scale will depend on the site and surrounding area and will therefore be different depending on the location of the site.

Limited Development: To mean more than small scale. In relation to the 'Named Settlements' in the Plan, any 'limited' development must be in scale and proportion to the settlement in which it is proposed.

District Shopping Centre: In this Local Plan refers to an area identified as containing the principal shopping areas of the three towns of Hucknall, Kirkby-in-Ashfield, and Sutton-in-Ashfield and shown on the Proposals Map with a specific boundary. Also referred to as a 'District Centre' within this plan.

Durable: See 'Comparison Goods' and 'Bulky Goods Retailing'.

Ecological Site: An area of natural history interest.

Edge-of-Centre Retailing: A location within easy walking distance (i.e. 200-300 metres) of a District Shopping Centre.

Employment: For the purposes of this Local Plan the term employment will normally refer to land intended for use within Classes B1 to B8, as defined in the Town and Country Planning (Use Classes) Order, 1987. Sui generis employment uses outside these categories may also be appropriate, subject to normal site planning considerations.

Enterprise Zone: A zone designated by the Secretary of State for the Environment, Transport and the Regions. Such areas attract special financial benefits and involve a simplified planning regime in order to attract a rapid rate of development and employment creation. A site at Sherwood Business Park to the south of Annesley Woodhouse was designated an EZ on 21st November, 1995.

Factory Shop: A retail outlet situated within a factory site selling goods manufactured either on the premises or elsewhere by that company.

Five Pits Trail: A recreational footpath and bridleway developed by local authorities in Derbyshire using derelict railway lines. It runs from Newton, in Bolsover District, in a northerly direction to Holmewood in North East Derbyshire District.

Formal Open Space: An area of land maintained for organised sport and recreation, play space for youths and children and as formally landscaped areas.

Greater Nottingham: Defined by the Nottinghamshire Structure Plan as the City of Nottingham, together with that area of land around the City of Nottingham outside the City limits but generally serving the needs of the Nottingham area, including Hucknall.

Green Belt: An area of land surrounding a City having five distinct purposes:

- i) to check the unrestricted sprawl of large built up areas;
- ii) to prevent neighbouring towns from merging into one another;
- iii) to assist in safeguarding the countryside from encroachment;
- iv) to preserve the setting and special character of historic towns and;
- v) to assist in urban regeneration by encouraging the recycling of derelict and other urban land.

Advice on planning and Green Belt is given in PPG2 revised in January 1995.

Green Wedge: An area of open land representing an important break between settlements.

Greenwood Community Forest: Launched in Nottinghamshire in November 1991 with a view to establishing, over a 30-50 year period, large areas of woodland and forest planting within an area of approximately 170 square miles. The whole of Ashfield District is included within this area.

Gypsy Caravan Sites: Circular 1/94 gives revised guidance on the planning aspects of sites for caravanning which provide accommodation for gypsies.

Ha/ha: Hectares.

Hectare: An area 10,000 sq. metres or 2.471 acres. (Roughly equivalent to two football pitches.)

Housing Investment Programme (HIP): An annual statement of the Council's policies and strategy for housing management in the area to secure Government funding.

"Important" Hedgerows: As defined by The Hedgerows Regulations 1997 made under section 97 of the Environment Act 1995. The Regulations enable local planning authorities to protect "important" hedgerows in the countryside by controlling their removal through a system of notification. A set of criteria is used to establish whether a hedgerow is important.

Infill Site: An area which can accommodate one or two dwellings within a small gap in existing development.

Informal Open Space: An area of land maintained as informal open space and often available for public use for activities such as walking, cycling and horseriding.

Joint Structure Plan Authority: Nottinghamshire County Council and Nottingham City Council acting as a joint Authority for the preparation of future Structure Plans.

Kirkby-in-Ashfield Local Plan: Adopted in October 1984. Superseded by the Ashfield Local Plan adopted in December 1995.

Landfill: Disposal of waste by using it to fill excavations or occasionally natural land features.

Land Requirement: The land needs for housing and employment purposes as required by the Nottinghamshire Structure Plan Review, to the year 2011.

Land Supply: The amount of land readily available or likely to become available within a specified period, usually five years.

Leisure Facilities: In respect of an appropriate use on specified employment sites, could include a public house, cinema, bowling alley or built sports related facility, but excludes retail uses.

Listed Buildings: A building or structure of special architectural or historic interest included on a list prepared by the Secretary of State for Culture, Media and Sport under Section 1 of the Planning (Listed Buildings and Conservation Areas) Act, 1990. Consent is normally required for its demolition in whole or part, and for any works of alteration or extension (both internal and external) which would affect its special interest.

Local Agenda 21: A process to develop a local programme of action for sustainable development.

Locally – Within the District of Ashfield and adjacent districts.

Local Nature Reserve: Established by a local authority under the powers of the National Parks and Access to the Countryside Act, 1949.

Local Plan: Comprises a Written Statement and a Proposals Map. The Written Statement includes the Authority's detailed policies and proposals for the development and use of land together with reasoned justification for these proposals. The Local Plan must be in general conformity with the Structure Plan.

Local Plan Inquiry: Held before an Inspector appointed by the Department of the Environment, Transport and the Regions to consider formal objections to the local plan.

Local Shopping Centres: Shopping areas of a significant size and variety either close to but not forming part of a District Shopping Centre, or serving local communities. Includes Annesley Road, Hucknall; Watnall Road, Hucknall; Outram Street, Sutton-in-Ashfield from Northern Bridge to Dalestorth Street and the communities of Huthwaite, Jacksdale and Stanton Hill.

Low Cost Housing: (see Affordable Housing)

Main Urban Areas: For the purposes of this Local Plan the three towns of Hucknall, Kirkby-in-Ashfield and Sutton-in-Ashfield with boundaries as defined on the Proposals Map. The boundary includes land within the existing urban areas, together with a small number of peripheral sites, in accordance with Structure Plan policies 1/2 and 1/3. In addition to the Main Urban Areas, Structure Plan Policy 1/2 identifies the Nottingham to Hucknall Public Transport Corridor along which development will also be concentrated.

Major Retail Development: Comprises development exceeding 1000 sq. m gross floorspace as defined in Nottinghamshire Structure Plan Review policy 6/2.

Manufacturing Industry: Extraction of minerals and ores other than fuels; manufacturing of metals, mineral products and chemicals. Metal goods, engineering and vehicle industries and other manufacturing industries. Sections C & D of the Standard Industrial Classification (1992).

Mature Landscape Areas: Areas identified by the County Council as being of landscape importance on the basis that they represent those areas least affected by intensive arable production, mineral extraction, commercial forestry, housing, industry, roads etc.

Minerals Local Plan: Prepared by Nottinghamshire County Council as Minerals Planning Authority and adopted in November 1997.

Minor Shopping Centres: Small groups of shops outside the District Shopping Centres or Local Shopping Centres.

Named Settlements: The settlements of Jacksdale, Selston, and Underwood, New Annesley, Brinsley and Bestwood as defined on the Proposals Map.

National Playing Fields Association (NPFA): The independent national charity which advises on the design, layout and safety of playing fields and other playing space. Also acquires, protects and improves playgrounds, playing fields and other playspace.

Net Density: See Density.

Nottingham Express Transit (NET): The proposed light rail system for Greater Nottingham. Phase 1 is intended to run from Nottingham Railway Station to Hucknall. Funding of £167 million was approved for this project in December 1998, and construction is expected to commence during 1999.

Nottinghamshire Structure Plan Review: Adopted by the County Council in November 1996. It replaces the 1991 Structure Plan, and provides the strategic guidance for land requirements to 2011.

Nottinghamshire Green Belt Local Plan: Adopted in June 1989, the Plan identifies the area around Nottingham designated as Green Belt. The Plan was superseded, in the Ashfield part, by the Ashfield Local Plan adopted in December 1995.

Open Areas: Areas of important informal open space within the Main Urban Areas or Named Settlements which are identified as protected from future development.

Open Breaks: Open land between settlements which provides a setting and separates them from other concentrations of development.

Open Space: See Public Open Space/Formal Open Space and Informal Open Space.

Outdoor Playing Space: Used by the NPFA to assess needs for formal playing space.

Out-of-Centre Retailing: A term relating to retail development outside the District Shopping Centres, but not necessarily outside urban areas.

Outline Planning Permission: Confirms the principle of developing land for a given land use, normally for a period of three years.

Pedestrian Priority Schemes: A scheme to reduce the amount of traffic within an area to provide greater priority and facilities for pedestrians.

Plan Period: The time period within which the plan will operate. The Ashfield Local Plan Review end-date is 2011.

Planning Conditions: Requirements attached to a grant of planning permission in order to ensure the effective and proper implementation of any given development.

Planning Obligation: A legally binding agreement under Section 106 of the Town and Country Planning Act, 1990, between the Local Authority and any person interested in land in their area for the purpose of restricting or regulating the development or use of the land, either permanently or during such periods as may be prescribed by the agreement. Usually used in connection with requirements for development on land outside the control of an applicant.

Planning Policy Guidance (PPG): Published by Central Government to provide concise and practical guidance. Planning policy guidance notes are produced for a variety of specific topics.

Primary Industry: Agriculture, Forestry and Fishing, Energy and Water Supply Industries. Includes coal mining. Sections A, B and C of the Standard Industrial Classification (1992).

Prestige Employment Site: Site providing a high quality environment and parkland setting in accordance with Policy 2/6 of the Nottinghamshire Structure Plan Review.

Proposals Map: A map illustrating each of the detailed policies and proposals in the written statement, defining sites for particular developments or land uses (see Local Plan).

Public Open Space: General term including all space for formal and informal recreation activities with access generally open to the public.

Public Transport Corridor: Structure Plan Policy 1/2 identifies such corridors in South Notts. where development will be concentrated including the Nottingham to Hucknall Public Transport Corridor. This corridor is based on public transport facilities currently provided by rail (the Robin Hood Line) and to be provided by Line 1 of the Nottingham Express Transit System (NET). The corridor is defined as being within 1km walking or cycling distance of the Robin Hood Line or NET stations.

Regional Planning Guidance (RPG): Issued by the Secretary of State for the Environment, Transport and the Regions. RPG8 (March '94) provides a framework for the preparation and review of development plans to 2011. East Midlands Region covers Nottinghamshire, Derbyshire, Lincolnshire, Leicestershire and Northamptonshire and the Peak District National Park. (*N.B. RPG8 superseded in January 2002*)

Renewable Energy: The term "renewable energy" covers those resources which occur and recur naturally in the environment. Such resources include heat from the earth or the sun, power from the wind and from water and energy from plant material and from the recycling of domestic, industrial or agricultural waste, and from recovering energy from domestic, industrial or agricultural waste.

Retail Development: For the purposes of policies in this Local Plan refers to uses generally occurring within Classes A1-A3 (inclusive) of the Town and Country Planning (Use Classes) Order 1987.

Retail Parks: Large development sites containing a concentration of at least three retail warehouses. Usually in out-of-centre locations on major highway routes.

Retail Warehouses: Large single-level stores specialising in the sale of household goods and DIY items, catering mainly for car-borne customers and often in out-of-centre locations.

Re-Use: A change from one use to another, or adapted for a different purpose.

Road-Related Development: Commercial developments providing goods and services to the travelling motorist. Includes such uses as petrol stations, restaurants, motels and hotels.

Robin Hood Line: The passenger railway line developed to connect Nottingham, Hucknall, Kirkby-in-Ashfield, Mansfield and Worksop. Phase 1 of the scheme from Nottingham to Newstead opened in May 1995. Phase II to Mansfield Woodhouse opened in November 1995. Phase III to Worksop was completed in June 1998.

Roll Forward: The process of extending the end-date of a Structure or Local Plan by carrying forward projections and policies to the new end-date taking into account existing requirements.

Rural Area: Those parts of the district identified in this Local Plan as Green Belt or Countryside.

Safeguard (From Development): The use of planning policies to prevent the loss of a site to development for purposes other than that for which the land is held in reserve, e.g. road schemes, open space, employment uses.

Selston: A 'Named Settlement' which includes Selston, Selston Green and Selston Common.

Semi-Mature Tree: A tree with a stem circumference of 20-75cm measured 1 metre above ground level (BS4043).

Sequential approach/test:

- A) Housing: The Sequential approach for housing is intended to identify housing sites for development in preferred locations. The preferred order for site identification is firstly the re-use of previously developed land and buildings, then other poorly used urban land and finally urban extensions. Accessibility of housing sites to major existing or proposed public transport nodes is also an important consideration in site identification.
- B) Retail & Leisure: The Sequential Test for retail and leisure sites is intended to identify development in preferred locations. The preferred order being firstly within District Shopping Centres then the edge of these centres, and finally out of centre.

Site of Importance for Nature Conservation (SINC): Site of local importance for nature conservation or geology as identified by the Nottinghamshire Wildlife Audit Steering Group.

Sites of Special Scientific Interest (SSSI): The designation under Section 28 of the Wildlife and Countryside Act, 1981, of an area of land of special interest by reason of any of its flora, fauna, geological or physiographical features.

South Notts: A sub-area of the Structure Plan containing the Greater Nottingham Conurbation. Includes the Hucknall part of Ashfield, the City of Nottingham and the Districts of Broxtowe, Gedling and Rushcliffe.

Supplementary Planning Guidance: Planning guidance which supplements the policies and proposals of the plan itself, for example housing design guides. Such guidance does not form part of the Local Plan Review.

Sustainable Development: A guiding principle for all activities in their relationship with the environment. One of the most popular definitions is that "sustainable development meets the needs of the present without compromising the ability of future generations to meet their own needs".

Sutton-in-Ashfield Local Plan: Adopted in November 1990. This plan was superseded by the Ashfield Local Plan adopted in December 1995.

Take-Up Rates: The rate at which land is developed. Usually measured in number of dwellings per annum or hectares of development per annum.

Teversal Trail: A recreational footpath and bridleway developed by local authorities in Nottinghamshire and Derbyshire using former railway lines and other trails in the Teversal area.

Town Centre: See "District Shopping Centre".

Transport Policies and Programme (TPP): An annual statement produced by the County Council of its transport policy and programme for development of transport works in the County. From 1999 this document will be replaced by the Local Transport Plan.

Use Classes Order: Section 55 of the Town and Country Planning Act 1990 provides that a change of use does not amount to development, and therefore does not require planning permission, where a former use and the new use are both within the same class specified in an order made under that paragraph. The Town and Country Planning (Use Classes) Order, 1987, is the operative order relating to that section of the Act.

Vitality and Viability: Referred to in PPG6 (major retail developments) as being an important consideration in determining the cumulative affect of out-of-centre retail developments on existing town centres. For example, the vitality and viability of a town centre could be affected by a significant increase in vacant properties and a marked reduction in the range of services a town centre provides, or a deterioration in the range and variety of shops and services provided.

Washed Over: An area of developed land outside the Main Urban Areas and Named Settlements, which is contained within the Green Belt.

Waste Local Plan: Prepared by the County Council acting as the Authority responsible for waste related issues including disposal, treatment, transfer and recycling within the County.

West Notts: A 'sub-area' of the Structure Plan including all of Ashfield north of Hucknall, Mansfield and parts of Newark and Sherwood District.

White Land: Land outside of Main Urban Areas and Named Settlements specifically excluded from Green Belt but safeguarded from development.

Windfall Sites: Areas of land capable of accommodating over ten dwellings for which planning permission is granted for that purpose without having been previously identified for such development in the local plan.

CHAPTER 1: INTRODUCTION

THE DEVELOPMENT PLAN SYSTEM

- 1.1 The Town and Country Planning Act, 1971, introduced a two-tier system of Structure Plans and Local Plans, which together form the statutory Development Plan for any particular area. The Town and Country Planning Act, 1990, consolidates this and subsequent legislation and confirms the basic system introduced in the 1971 Act.
- 1.2 The Structure Plan, which is the responsibility of the County Council, deals with key strategic policies and provides the framework for Local Plans. Local Plans set out detailed policies and specific proposals for the development and use of land, and provide a detailed basis for the control of development.
- 1.3 The Town and Country Planning Act, 1990, strengthens the roles of Structure and Local Plans. It introduces a presumption in favour of proposals which accord with the Development Plan unless other material considerations indicate otherwise. The Planning and Compensation Act, 1991, has also made the preparation of a district-wide local plan mandatory.

POLICY CONTEXT FOR THE ASHFIELD LOCAL PLAN REVIEW

- 1.4 The Ashfield Local Plan Review takes account of several key considerations in terms of its policy context. These include central government advice, the Nottinghamshire Structure Plan Review the Ashfield Local Plan (adopted December 1995) and the Minerals and Waste Local Plans.

Central Government Policy

- 1.5 The government sets out legislation, such as that referred to in paras. 1.1 and 1.3, prepares Circulars and the other consultation documents and issues Planning Policy Guidance (PPG) and Regional Planning Guidance (RPG). PPG provides government advice on particular topics and are material considerations which must be taken into account where relevant to decisions on planning applications. The Secretary of State for the Environment issued RPG for the East Midlands in March 1994 which provided guidance for development in the East Midlands to 2011. This guidance was taken into account in the preparation of the Nottinghamshire Structure Plan Review to which this Local Plan Review must conform.

Nottinghamshire Structure Plan Review

- 1.6 The Nottinghamshire Replacement Structure Plan was approved on 12th September, 1991, and provided the strategic framework for the period to 2001 which formed the basis of the Ashfield Local Plan adopted in December 1995.
- 1.7 The process of Review of the Structure Plan commenced in 1992 with the intention of rolling forward policies to 2011. An Examination in Public was held in January and May 1995 and the Nottinghamshire Structure Plan Review was formally adopted in November 1996. This revised plan provides the basis for housing and employment land requirements to 2011 enabling the Nottinghamshire districts to prepare new local plans to the same end date. It also provides a basis for a review of the Green Belt, within the local plan process, as requested by the Secretary of State for the Environment in 1991.

Ashfield Local Plan

- 1.8 The Ashfield Local Plan was adopted in December 1995 and provides detailed planning policies and proposals for the District up to the year 2001. It was prepared in accordance with the Nottinghamshire Replacement Structure Plan 1991. At its adoption the Ashfield Local Plan superseded and replaced the Kirkby-in-Ashfield Local Plan, the Sutton-in-Ashfield Local Plan and that part of the Nottinghamshire Green Belt Local Plan relating to Ashfield.
- 1.9 Outside the context of the adopted Ashfield Local Plan the only other Local Plans relevant to Ashfield are the Minerals Local Plan prepared by the County Council and the Waste Local Plan prepared jointly by the City and County Councils.

LOCAL PLAN REVIEW MAIN ISSUES REPORT

- 1.10 The Ashfield Local Plan Review Main Issues and Site Allocations report was published as an officer document in July 1997. This was prepared as an initial public consultation document to examine the main issues in relation to increased housing and employment land requirements arising from the Nottinghamshire Structure Plan Review. The document suggested potential preferred locations for the new development and also considered a number of other sites which at that time were considered less appropriate and, in the context of that document, were therefore rejected.
- 1.11 The publication of the Main Issues report gave rise to widespread objections to new development requirements, particularly where this involved development in Green Belt or Countryside. Arising from the objections raised and in the context of newly emerging Government advice the Local Plan Review Main Issues report has to some extent been superseded. Further detailed research work, particularly in relation to urban capacity and housing density, has indicated the potential to reduce development requirements in the countryside. The underlying basis for site choice contained in this plan does however relate to the strategy as originally outlined in the Main Issues report, but does so in the context of a more sustainable approach to development requirements.

FORM OF THE LOCAL PLAN

- 1.12 This Local Plan Review comprises a written statement and a proposals map covering the entire District. The Map, consisting of north and south sheets, indicates the location of proposals for the development of land and areas over which particular policies will apply. The Plan is divided into a number of topic sections, each of which contains specific policies which will themselves be followed by supporting text, as reasoned justification. The first topic section (Chapter 2) will establish an overall strategy context for the more specific topic sections which follow in Chapters 3 to 8.
- 1.13 The Local Planning Authority has over a long period of time approved specific development control policies for certain topics. The Local Plan Review will up-date existing development control policies and incorporate new policies as necessary into relevant topic chapters.
- 1.14 More detailed guidance concerning the standards required to meet the development control criteria is included in the form of Supplementary Planning Guidance published separately by the Council.

DEPARTURE PROCEDURE

- 1.15 Where exceptional circumstances require that proposals should be considered outside the context of Local Plan policies, the District Council will invoke the departure procedure under the Town and Country Planning (General Development Procedure) Order 1995. Any decisions arising from this process which affect the principle of any policies will be reflected in a subsequent review of the Plan.

CONSULTATION

- 1.16 The Ashfield Local Plan Review has been subject to the formal process of public consultation as laid out in the Town and Country Planning (Development Plan) Regulations 1991.
- 1.17 In accordance with the normal practice of the Authority, the Council has, where appropriate, held discussions with objectors to determine whether agreement can be reached over any aspect of that objection. This has been done to reduce time at the subsequent inquiry and to ensure that the plan properly represents the views of those involved in the future development of Ashfield District.

CHAPTER 2: LOCAL PLAN REVIEW STRATEGY

INTRODUCTION

- 2.1 This chapter outlines and explains the overall Local Plan Review strategy in the light of recent central government advice, the strategic framework provided by the Nottinghamshire Structure Plan Review and the existing character of the District. Subsequent chapters give more detailed policies on specific topics in the light of the overall strategy.
- 2.2 The Ashfield Local Plan Review accords closely with the general strategic framework provided by the Structure Plan Review. It sets out more detailed policies and proposals which cover either all or part of the District to guide day-to-day planning decisions to the year 2011. The Local Plan Review also incorporates many of the policies from the adopted Ashfield Local Plan.

CENTRAL GOVERNMENT ADVICE

Planning Policy Guidance

- 2.3 PPG12 'Development Plans' gives advice on the preparation of various types of Development Plans, including Local Plans. It indicates that they need to be in general conformity with the Structure Plan, and to set out the Authority's policies for the control of development, make proposals for the development and use of land, and allocate particular areas for specific purposes. Local Plans are required to include policies relating to the conservation of the natural beauty and amenity of land, improvement of the physical environment and the management of traffic. PPG12 and other PPGs recommend the inclusion of policies on other topics. These are referred to in appropriate subsequent chapters. PPG12 also indicates that development control policies are to be incorporated where they can be used as a basis for either a refusal of a planning application or the imposition of conditions on a planning permission.

Sustainable Development

- 2.4 Since 1990 with the publication of the White Paper 'This Common Inheritance', the need to ensure that development and growth are sustainable has been central to government objectives. This concept is embodied in PPG12 as a basic requirement for Local Plans and has been further elaborated upon in later publications including 'Sustainable Development: The UK Strategy' in 1994. In 1994 the Government also published 'Biodiversity: The UK Action Plan' in response to Agenda 21, a global programme for sustainable development. The latest Government strategy for sustainable development was published in May 1999 in a document called "A better quality of life, a strategy for sustainable development in the UK." More recently the Government has published a consultation paper 'Planning for Communities of the Future' (Jan. '98) which establishes increased targets for development on 'previously developed' sites, a white paper 'A New Deal for Transport: Better for Everyone' (July '98) to encourage improvements to transport choice, particularly public transport to secure mobility that is sustainable in the future and a good practice guide 'Planning for Sustainable Development: Towards Better Practice' (Oct '98). PPG13 'Transport' refers to the need to ensure that journeys, particularly by private car, are minimised and that new development should be well related to urban areas in general and in particular to accessible public transport. PPG6 'Town Centres and Retail' established the concept of the 'sequential test' to ensure that new developments, particularly retail, employment and leisure uses are well related to town centres. All issues relating to sustainable development are embodied within the overall strategic approach to land use issues in this Plan.

ASHFIELD DISTRICT : BACKGROUND

- 2.5 Ashfield District is located on the western side of Nottinghamshire. It adjoins five districts within the County including Nottingham City to the south and Mansfield to the north and east, as well as part of the boundary with Derbyshire (see Map A on page 23).
- 2.6 There are three Main Urban Areas in the District where housing, jobs and services are generally concentrated. The southernmost is Hucknall which lies immediately north of Nottingham. Kirkby-in-Ashfield and Sutton-in-Ashfield are to the north of the District and include the adjoining

settlements of Kirkby Woodhouse/Annesley Woodhouse/Nuncargate and Huthwaite, Stanton Hill and Skegby areas respectively. Three settlements, Jacksdale, Selston and Underwood, also contain significant residential areas, but lack the concentration of employment opportunities and services found in the main centres. The remainder of the District is primarily countryside but containing a number of smaller settlements. See Map B on page 24.

- 2.7 The District has excellent road links to much of the country due to its location beside the M1 motorway which joins with other major routes. M1 Junction 26, which is outside the District, provides a good link to Hucknall now that new routes around Bulwell are complete. M1 Junction 27 lies within the District and provides a major link to Ashfield's three towns via the A608 and A611. The A38 provides an important route from the motorway at M1 Junction 28 to Sutton-in-Ashfield and Kirkby-in-Ashfield and to Mansfield via the A38 by-pass.

THE STRUCTURE PLAN REVIEW

- 2.8 The principle strategy arising from the 1991 Structure Plan remains valid within the Structure Plan Review and can be summarised as follows:

- a) To concentrate development within or adjoining the Main Urban Areas. (In Ashfield; Hucknall/Kirkby-in-Ashfield/Sutton-in-Ashfield).
- b) To allow some limited development within villages. (In Ashfield, Selston, Jacksdale, Underwood, Bestwood, Brinsley and New Annesley).
- c) To assist in the regeneration of mining areas and other areas suffering economic and environmental problems.
- d) To maximise the use of existing roads by giving priority to movement of essential traffic.
- e) To protect and enhance existing town centres. (In Ashfield; Hucknall/ Kirkby-in-Ashfield/ Sutton-in-Ashfield).
- f) To make the best use of existing infrastructure and services together with the conservation of resources such as energy.

- 2.9 In order to take account of development needs to 2011 the Structure Plan Review also reflects the need to:

- a) Assist in regenerating and restructuring the local economy by ensuring that land and infrastructure needed to 2011 is provided in the right location.
- b) Sustain the quality of the environment.
- c) Improve accessibility within the County and the rest of Britain.

- 2.10 The main strategic policies of the Structure Plan therefore contain the following requirements (summarised in relation to Ashfield District):-

- 2.11 Policy 1/1: Make provision for the scale of economic development necessary to meet the needs of the County's population to 2011. This will involve:-

- a) Provision of a wide range of sites for appropriate economic activity.
- b) Provision and promotion of necessary transport and other infrastructure.
- c) Provision of sufficient housing sites.
- d) Protection of valuable environmental and heritage features.
- e) Protection of countryside and, in particular, Green Belt.
- f) Development which is energy efficient in terms of location, layout and design.
- g) The re-use of derelict and degraded land.
- h) Environmental improvement, habitat creation, planting and conservation schemes.
- i) Protection and provision of open space for amenity and recreation.

- 2.12 Policy 1/2: Major new development will be concentrated within and adjoining the Main Urban Areas and along identified Public Transport Corridors, including (in Ashfield) - Nottingham to Hucknall. Major new development will only be permitted where it can be fully integrated with new or existing public transport facilities.

- 2.13 Policy 1/3: Outside Main Urban Areas and Public Transport Corridors limited provision for development will be made in villages identified in Local Plans.

Structure Plan Sub Areas

- 2.14 In considering development needs the Structure Plan has divided the County into five Sub-Areas based on the main travel-to-work areas of the County, adjusted to conform to District Council boundaries. Ashfield lies within two such Sub-Areas. The Hucknall area forms part of the South Nottinghamshire Sub-Area and the remaining parts of the District including Kirkby-in-Ashfield and Sutton-in-Ashfield fall within the West Nottinghamshire Sub-Area. Ashfield development land requirements are allocated in the Structure Plan on the basis of the relevant parts of these Sub-Areas relating to the District. The Sub-Area boundary is shown on Map B on page 24 and on the Proposals Map.
- 2.15 The Structure Plan allows for a considerable increase in the scale of development in the three Main Urban Areas of Ashfield between 1991 and 2011. In the Hucknall part of the South Nottinghamshire Sub-Area, it anticipates the construction of some 3,000 dwellings and provides for some 70 hectares of employment development. In the Sutton-in-Ashfield and Kirkby-in-Ashfield parts of the West Nottinghamshire Sub-Area, it allows for some 5,550 houses and 235 hectares of land for employment (Structure Plan policies 2/1, 4/1, 13/1, 13/2, 13/5 and 13/6 refer).
- 2.16 The overall proposals in the Structure Plan Review comprise a continuation and roll-forward of the strategy of the Structure Plan approved in 1991 which formed the context for the Ashfield Local Plan prepared by this Authority and adopted in December 1995.

Green Belt Review

- 2.17 When approving the Structure Plan in 1991, the Secretary of State for the Environment recognised that by the (then) Structure Plan end date of 2001 the land supply situation in Greater Nottingham could be such that further development may only be possible by using land currently allocated for open space or by pushing out into the Green Belt. He therefore agreed that Green Belt boundaries should be reviewed by the appropriate District Councils in their local plans, if possible by the mid 1990's, in order to meet longer term requirements.
- 2.18 The context for the Green Belt Review has been established in the Nottinghamshire Structure Plan Review. Policy 1/5 provides guidance for Green Belt revision and for safeguarded land in relation to meeting those land requirements, this requires the Green Belt to have regard to:-
- a) The provision of strategic development policies.
 - b) The need to protect land which fulfils Green Belt purposes.
 - c) The need for the boundary to follow recognisable and defensible features.
 - d) The protection of "white land" where the nearest defensible boundary is drawn beyond that required for land needs to 2011.
 - e) The protection of major "ridge lines" and important open breaks between distinctive settlements. (The break between Nottingham City and Hucknall is specifically identified.)
- 2.19 The purposes of including or keeping land in Green Belts as set out in PPG2 (Green Belts) are to:-
- a) Check the unrestricted sprawl of large built-up areas.
 - b) Prevent neighbouring towns from merging.
 - c) Assist in safeguarding the countryside from encroachment.
 - d) Preserve the setting and character of historic towns; and
 - e) Assist in urban regeneration.

Apart from (d) all these purposes are important in relation to the Ashfield part of the Nottinghamshire Green Belt.

AIMS AND OBJECTIVES OF THE LOCAL PLAN

- 2.20 The Ashfield Local Plan Review reflects the aims of the Structure Plan Review in setting a framework for development, namely:-

- a) To protect and enhance the environment.
- b) Meet the employment needs to 2011 of those who depend on the district for jobs.
- c) Meet the overall housing needs to 2011 of the District in appropriate locations.
- d) Balance the need for development with the need to maintain the quality of the environment.
- e) Make optimum use of the scarce resources of land, finance and labour.
- f) To enhance town centres.

2.21 In achieving these aims the Local Plan Review has the following strategic objectives, all of which embody the principles of sustainability, as referred to in paragraph 2.4, within all its policies. This can be summarised as follows:

- a) Concentration of development into the Main Urban Areas, to prevent sprawl, maintain the quality of countryside, minimise the need to travel and maximise the use of vacant and derelict land within the urban areas.
- b) Protection of the countryside including its open character, landscape, wildlife, agricultural, recreational and natural resource value. Where development in the countryside is unavoidable, to identify opportunities for enhancement elsewhere or to create, where possible, alternative habitats. The development of the Greenwood Community Forest and reclamation and enhancement of derelict land in countryside areas is a key part of this approach.
- c) Protection of the built heritage including important buildings, related open spaces, ancient monuments, archaeological sites and their settings.
- d) Control of pollution where planning powers permit, and safeguard the amenity of proposed developments from all forms of pollution.
- e) Consider land use and transport objectives together to minimise the need to travel, particularly by car. Locating major traffic generating uses close to existing centres and public transport facilities. The strengthening of existing town centres, particularly the local shopping environment. The improvement of transport choice by providing safe routes to encourage walking and cycling.
- f) Protect and enhance leisure resources including open space, playing fields and recreational routeways and improve access to areas of countryside.

ENVIRONMENTAL APPRAISAL

2.22 PPG 12 refers to the need to ensure that development and growth are sustainable such that future generations are not denied the best of today's environment. Environmental Appraisal has been used to achieve this through an ongoing process of identifying and evaluating environmental effects of policies and proposals considered in the review of the Ashfield Local Plan.

2.23 Environmental Appraisal of the Ashfield Local Plan Review is considered in detail in Technical Paper No. 7 'Environmental Appraisal'. The process of appraising the Review Local Plan has been an integral part of its ongoing preparation. Options for plan policies and site proposals have been considered not only in respect of their environmental impact but also against economic and social factors. In particular the Local Plan is required to meet employment and housing need identified in the Structure Plan Review. As such it is recognised that there will be some unavoidable adverse effects on the environment but through the process of appraisal these can be identified, assessed and minimised or compensated for, where feasible.

2.24 The Main Issues and Site Allocations report published in July 1997 formed part of the ongoing appraisal of the Local Plan. This included consideration of the preferred strategy for development and a detailed appraisal of preferred sites for housing and employment development. Sites considered and subsequently rejected were also included in this report. The assessment of sites involved consideration of all available environmental information and consultation with statutory authorities and other environmental bodies. Following consideration of all matters arising from the consultation exercise on the Main Issues report, all site proposals were reconsidered together with sites proposed by objectors to the report. A revised strategy based on an assessment of urban capacity referred to in paragraphs 2.43 and 2.44 was also considered along with a revised approach to housing density and adoption of a sequential approach to identifying housing and retail sites for development. The revised strategy adopted in this Local

Plan has allowed a considerable reduction in environmental impact compared with that proposed in the Main Issues report.

- 2.25 Technical Paper No. 7 'Environmental Appraisal' considers all policies and proposals put forward in this Local Plan against a comprehensive set of environmental criteria. The impact of the policies and proposals is indicated in a matrix intended to show the balance of effects on environmental assets from positive to negative. Some negative impacts are unavoidable and these are identified. Remedial or compensatory action to minimise adverse environmental effects are indicated and this is subsequently included in the policies, supporting text or site briefs in this plan.

SETTLEMENT HIERARCHY

- 2.26 There is a clear settlement hierarchy in Ashfield District. The first level covers the Main Urban Areas of Hucknall, Kirkby-in-Ashfield and Sutton-in-Ashfield. The second comprises the villages of Jacksdale, Selston, Underwood and New Annesley and the Ashfield part of the larger settlements of Bestwood and Brinsley. The third consists of other smaller settlements within countryside. The current commitment to development, in terms both of recent planning permissions and policies of the adopted Ashfield Local Plan, reflects the general size and role of these settlements. The proposals for the District contained in the Structure Plan Review reaffirm this situation. The Local Plan Review closely reflects the most recent strategic over-view provided by the Structure Plan Review and hence involves no fundamental change in attitude to development in the District. It provides for new development where there is already a concentration of services and facilities and restricts development in other areas where services and facilities are less evident and would be more expensive to provide. Hence, the general size of settlements in relation to each other will be unaffected and their current roles are confirmed. Elsewhere in Ashfield, development will not normally be permitted.
- 2.27 Policies ST1 to ST4 below express in overall terms the approach of the District Council to the future physical form of the District. These, together with appropriate detailed policies in later chapters, are consistent with the aims referred to in para. 2.20 above and Structure Plan Review strategy policies 1/1 to 1/3.

DEVELOPMENT

POLICY ST1 DEVELOPMENT WILL BE PERMITTED WHERE:-

- a) **IT WILL NOT CONFLICT WITH OTHER POLICIES IN THIS LOCAL PLAN,**
- b) **IT WILL NOT ADVERSELY AFFECT THE CHARACTER, QUALITY, AMENITY OR SAFETY OF THE ENVIRONMENT,**
- c) **IT WILL NOT ADVERSELY AFFECT HIGHWAY SAFETY, OR THE CAPACITY OF THE TRANSPORT SYSTEM,**
- d) **IT WILL NOT PREJUDICE THE COMPREHENSIVE DEVELOPMENT OF AN AREA,**
- e) *IT WILL NOT CONFLICT WITH AN ADJOINING OR NEARBY LAND USE.*

- 2.28 Government advice states that in general the planning system operates on the principle that planning permission should be granted unless the development would cause demonstrable harm to interests of acknowledged importance, and those who decide planning applications and appeals must give clear and well founded reasons for refusing planning permission. Policy ST1 represents the general policy against which all development proposals will be assessed irrespective of land use. It outlines the basic criteria which all development proposals must satisfy and therefore applies to all the land use based policies in the Plan. Hence, development proposals must accord with the land use policies contained within the Local Plan Review if they are to gain the support of the Authority.
- 2.29 A development must not adversely affect the character, quality, amenity or safety of the built or natural environment, wherever it occurs. This will include the need to protect open spaces and playing fields in urban areas and elsewhere. The appearance of a proposed development and its relationship with its surroundings are material considerations in determining planning

applications and the Authority will not accept any development which adversely affects the local environment. Where possible the Council will promote good quality design solutions which respect and enhance the local character of an area. Design solutions which provide a safer and more secure environment to assist with planning out crime and which incorporate energy efficient layouts will be encouraged. This consideration will apply equally to all forms of development, involving both built development and changes of use of buildings.

- 2.30 The landscape treatment of the site should be one of the main considerations in any development proposal. Developers should take into account the landscape characteristics of the area, significant landscape features of the site and the potential of the site to contribute to the character and appearance of the area. Sympathetic and effective boundary treatment together with good quality landscaping can improve the setting and appearance of new developments and make them more acceptable. This should include the retention of valuable existing features and habitats, wherever possible, and the use of native and other complementary species.
- 2.31 All developments must have a safe means of access which is adequate to serve the proposal and does not adversely affect pedestrian or vehicular safety. The capacity of the transport system to take new development will also be considered. It is therefore likely that transport impact assessments will be required for major proposals and developers should consider undertaking such a study in advance of the submission of a planning application in order to facilitate its full and proper consideration. In a wider context the likelihood of larger developments affecting the capacity of motorway junctions will be considered by the Highways Agency. In addition, appropriate car parking facilities must be provided which are well related to the development and are laid out in a usable form. The Council's agreed car parking standards are contained in Appendix 7.
- 2.32 Some developments, due to the relationship between the site and adjacent land, may prove to be unacceptable as their implementation in isolation could adversely affect the more comprehensive development of an area of land at a later date. In such circumstances developers will be encouraged to contact adjacent land owners to seek a comprehensive solution.
- 2.33 Some developments which are acceptable in one location may be unacceptable in another due to possible conflicts with adjacent or nearby land uses. This may include such issues as diverse as a new lighting scheme which may result in glare or light spillage beyond the site, for example the floodlighting of a sports facility adjacent to residential properties. New industrial uses may also be unacceptable close to residential areas or existing uses may generate noise, smells, vibrations etc. which render nearby sites unsuitable for other uses.

GENERAL LOCATION OF DEVELOPMENT

- 2.34 The principal aims and objectives established in the adopted Local Plan still remain essential to the Local Plan Review. With increasing requirements for development land it is important that the main strategic approach of the plan is retained. It is however recognised that in some cases the release of development land in both the Green Belt and other areas of countryside will be required and it is necessary to consider a method of identifying the most appropriate way of determining the suitability of such sites.
- 2.35 In general terms therefore the review has adopted a "sequential" approach to site identification in accordance with PPG3. This is based on Structure Plan Review policy of identifying land within urban areas as a priority, followed by sites adjoining urban areas, and finally, only when the first two options have been exhausted, to consider sites elsewhere.
- 2.36 In considering the release of sites for development which are currently within the Green Belt or other countryside, the Council will wish to ensure that those sites which have the minimum impact on the general purposes of Green Belt and Countryside are the preferred sites. In this respect, each site considered has been tested against these purposes. Sites will be preferred where the loss of a Green Belt area or other countryside can be minimised or "contained" within firm and defensible boundaries and where this is unlikely to lead to further loss of land to development in the future. In the case of sites in Hucknall, the need to maintain the open break with Nottingham City is of paramount importance.

White Land

- 2.37 The Structure Plan Review places no requirement on Districts to identify land for development needs beyond 2011. The consideration of development needs to 2011 has involved a review of Green Belt to identify firm defensible boundaries once account has been taken of land requirements to 2011. The Structure Plan advises that where such defensible Green Belt boundaries exist beyond a line necessary to meet 2011 land requirements then the remaining areas should be identified as white land and safeguarded for future development needs. There is currently no Regional Planning Guidance to determine development needs beyond 2011.
- 2.38 The Council is concerned to ensure that the development needs of the South Nottinghamshire Sub-Area beyond 2011 are considered as a whole. In allocating all land beyond existing urban area boundaries which is necessary to meet Structure Plan requirements to 2011, the Council has undertaken, where appropriate, a review of Green Belt. Green Belt boundaries have been established which follow firm and defensible features and which in all cases do not identify land beyond that which would be required to meet needs to 2011. Consequently it has not been necessary to identify white land within this Local Plan Review. Land within the reviewed Green Belt should remain so until land needs beyond 2011 have been properly identified in the context of all land requirements across all relevant Structure Plan Sub Areas. The Council considers this approach, which could lead to a subsequent Green Belt Review, preferable to the premature identification of white land against uncertain future land requirements.

Public Transport Corridors

- 2.39 In the South Nottinghamshire Sub-Area the Structure Plan Review identifies a series of Public Transport Corridors along which development should be concentrated. The identification of such corridors is based on the principles of sustainable development and the objectives of PPG13 which encourages travel by public transport to reduce the use of the private car. This will in turn reduce fuel consumption and congestion on the roads by making the most efficient use of transport facilities in relation to land use.
- 2.40 In Ashfield, the Nottingham to Hucknall corridor is identified in Structure Plan Review Policy 1/2. The corridor is centred on public transport facilities currently provided by rail (The Robin Hood Line) and by line 1 of the Nottingham Express Transit System (NET). This is because rail-based facilities are more efficient than road-based facilities in terms of the numbers of people they can transport to and from the City Centre, particularly during busy periods. The NET system when operational will be a high frequency, high capacity system capable of transporting up to 1,200 people per hour from Hucknall to Nottingham at peak times.
- 2.41 In identifying development sites within the Hucknall area a significant criteria has therefore been the accessibility of land to either a Robin Hood Line Station or a proposed NET stop. Sites which are within 1km of such a facility are preferred since this reflects a reasonable maximum distance for walking to a station. Beyond this distance, sites which are well served by main bus routes, preferably linking to a railway station, will be considered. Sites which cannot meet these criteria have only been considered as a last resort where there is the potential to improve public transport facilities in the future. Such improvements are most likely to be bus based.
- 2.42 The Authority has also considered the potential of larger sites to justify new rail or NET facilities in the future. However, it is unlikely that a new Robin Hood Line station could be provided since there are capacity constraints on the line caused by a long single track section and there are already sufficient station sites at appropriate locations for a successful heavy rail operation. Proposals for new housing and employment development to the north of Hucknall are currently being considered as part of the Gedling Local Plan Review process. Whilst the outcome of this process is not currently finalised, a safeguarded route has been identified between Hucknall Station and the boundary with Gedling Borough to the north. This will allow for a potential extension of the NET system, should this be required in the future, to widen transport choices in this area.

- 2.43 The principles of accessibility to public transport facilities have also been considered in relation to sites in the West Nottinghamshire Sub-Area. While no Public Transport Corridor is identified, parts of the area are served by the Robin Hood Line, particularly in Kirkby, and therefore sites can be considered in the same way as South Nottinghamshire sites. Considerations of accessibility also include the need to identify sites within walking distance of existing bus routes and with good cycle access.

Urban Capacity

- 2.44 In meeting the aims of the plan in relation to concentration of development within urban areas, and in support of the objectives of sustainability, an exercise has therefore been undertaken within all urban areas of the District to identify potential development sites. This has involved a detailed investigation of all undeveloped sites and open areas including allotments, open space, derelict sites and vacant sites and buildings. The details of the exercise are contained in Technical Paper No.1: 'Urban Capacity'. Some of the sites identified in the Local Plan Review have arisen from this Urban Capacity exercise and others, mainly smaller sites under 0.4 hectares may come forward for development during the plan period.
- 2.45 While indicating that some development land clearly exists within the existing urban area, the study also shows that overall needs for both housing and employment land will need to encroach into open countryside, which in the southern part of the District will involve loss of Green Belt. Accordingly sites which have been identified for development adjoining the urban area have been carefully selected in accordance with the "sequential" approach referred to in paragraph 2.35 and 2.36 to ensure the minimum of impact on the open countryside and to ensure the purposes of Green Belt are not undermined.

MAIN URBAN AREAS

POLICY ST2 DEVELOPMENT WILL BE CONCENTRATED WITHIN THE MAIN URBAN AREAS OF HUCKNALL, KIRKBY-IN-ASHFIELD AND SUTTON-IN-ASHFIELD AS SHOWN ON THE PROPOSALS MAP.

- 2.46 Most of the specific land use allocations in subsequent chapters are concentrated in these three Main Urban Areas. In addition, it is proposed that, in general, other proposals which emerge during the Plan period and do not conflict with specific land use designations or with development control criteria will be encouraged in these areas where services are concentrated and access to facilities is best.
- 2.47 As indicated in para. 2.26, it is anticipated that the general role of Hucknall, Kirkby-in-Ashfield and Sutton-in-Ashfield as the main employment, housing and service centres in the District will remain largely unchanged in coming years, as will the positive attitude of the District Council to development in these areas. As a result, policy ST2 does not distinguish between the three towns in terms of the overall strategic attitude to development, but looks to concentrate new development in each of them during the Plan period.
- 2.48 The Structure Plan Review proposes the concentration of new development within and adjoining existing urban areas, and in the case of Hucknall along identified 'Public Transport Corridors'. The scale of additional development needs to 2011 has meant that capacity of the Main Urban Areas identified within the adopted Ashfield Local Plan is insufficient to provide for all new requirements.
- 2.49 The precise boundaries of the Main Urban Areas have therefore been redrawn to reflect both existing and proposed development, and are shown on the Proposals Map. Wherever possible, previously established boundaries have been retained. Where encroachment onto land previously identified as Green Belt or other Countryside is proposed, boundaries have been drawn to minimise further loss of countryside using identifiable strong boundaries wherever possible. Hence the policy wording makes no further provision for developments 'adjoining' these urban areas. Other developments on the edge of the identified Main Urban Areas will be unacceptable unless they conform with Green Belt or Countryside policies (EV1 and EV2).

NAMED SETTLEMENTS

POLICY ST3 LIMITED DEVELOPMENT WILL BE PERMITTED WITHIN THE NAMED SETTLEMENTS OF JACKSDALE, SELSTON, UNDERWOOD, BESTWOOD, BRINSLEY AND NEW ANNESLEY AS SHOWN ON THE PROPOSALS MAP.

- 2.50 Structure Plan Review Policy 1/3, provides for limited development in certain settlements in the County to be identified in Local Plans. This is to provide for housing in rural areas and to allow for small-scale employment uses to diversify the rural economy. The term 'limited development' refers to the total amount of development in each settlement and not to the limit on any one particular site. It is not intended that the overall amount of development in the settlements should be significant in relation to that which will be concentrated in the Main Urban Areas. In practical terms the amount of development will be limited by the size and availability of sites within these tightly defined settlements.
- 2.51 Policy ST3 stipulates that in Ashfield District these Named Settlements are to be Jacksdale, Selston, Underwood, Bestwood, Brinsley and New Annesley. Selston is a loosely knit settlement and includes Selston itself, Selston Common, and Selston Green which together with Jacksdale and Underwood are the three largest settlements outside the Main Urban Areas. They contain substantial areas of housing development, constructed in the last 150 years, retain some employment uses despite colliery closures and, especially in the case of Jacksdale, act as local service centres. Bestwood and Brinsley both form parts of larger settlements which project into the District from Gedling Borough and Broxtowe Borough respectively. The review of Green Belt in Ashfield and in draft Local Plan consultations in Gedling recommends that Bestwood should be removed from the Green Belt and hence development that may arise within Bestwood will be dealt with under this policy. New Annesley is a smaller settlement lying between Annesley Woodhouse to the west and Annesley Colliery and Newstead to the south east. The Named Settlements do not possess the physical scope for major future development as is the case in the Main Urban Areas and are closely constrained by the Green Belt which defines the extent of the settlements. It is not therefore anticipated that the role of these settlements in the overall hierarchy will change, but that their positions will be consolidated through the acceptance where appropriate of a limited amount of development.
- 2.52 As indicated in para. 2.46, most land use allocations are to be made in the Main Urban Areas. This is to take advantage of local employment and service opportunities and the availability of substantial areas of suitable land. However, development at a scale relative to the size and position of the Named Settlements will be permitted and several new sites have been allocated for housing.
- 2.53 Development arising within the Named Settlements will contribute towards the total requirements for the respective Ashfield parts of the Sub-Area as defined in the Structure Plan Review.

THE REMAINDER OF THE DISTRICT

POLICY ST4 OUTSIDE THE MAIN URBAN AREAS AND NAMED SETTLEMENTS PERMISSION WILL ONLY BE GIVEN FOR:-

- a) **SITES ALLOCATED FOR DEVELOPMENT,**
- b) **DEVELOPMENT APPROPRIATE TO THE GREEN BELT OR THE COUNTRYSIDE AS SET OUT IN POLICIES EV1 AND EV2.**

- 2.54 Policy ST4 allows for development needs outside the Main Urban Areas and Named Settlements. In general terms the areas covered by this policy relate to the countryside including the Green Belt, to other areas specifically identified for development and to smaller villages, or parts of villages not covered by ST3 above.
- 2.55 Sherwood Business Park is excluded from Green Belt and was declared as an Enterprise Zone by the Government in August 1995. The Enterprise Zone Scheme grants planning permission for B1, B2 and B8 uses together with a site suitable for hotel and conference facilities. Major inward

investment has already been achieved within this key strategic site and it is anticipated that development of the whole area could be complete by 2000. In the unlikely event that development is not complete before the expiry of the Enterprise Zone designation in 2005 Policy ST4 and employment Policy EM1 will set the context for further development on the site.

- 2.56 Annesley and Bentinck Collieries were closed in early 2000. This policy makes provision for their development for new employment purposes. Both sites are allocated for employment uses under Policy EM1. Employment sites are also allocated under Policy EM1 at Blenheim Lane Industrial Estate and South West of Oakham Business Park to extend, and benefit from the presence of adjacent existing industrial areas in Nottingham City and Mansfield.
- 2.57 A general policy of restraint applies to all other areas outside the Main Urban Areas and Named Settlements. However, the southern part of Ashfield District lies within the Nottinghamshire Green Belt where the attitude towards development is even stricter than elsewhere in rural areas. Policies EV1 and EV2 explain in detail the limitations to development in the Green Belt and the remaining Countryside in Ashfield respectively'. Policy EV2, 'The Countryside', refers to those rural parts of Ashfield lying outside the Main Urban Areas and Named Settlements which are not in the Green Belt.
- 2.58 Structure Plan Review policy 1/3 indicates that, outside the Main Urban Areas and Named Settlements, permission will not normally be given for development, except for appropriate small-scale development in villages and development requiring a rural location. This is defined in policies EV1 and EV2 as appropriate development. The footnote to Structure Plan Review policy 1/3 states that in appropriate villages 'limited' means more than 'small-scale'. Further, small-scale refers to both the total level of development in each village as well as individual sites.

MAP A: Ashfield: Nottinghamshire County Setting

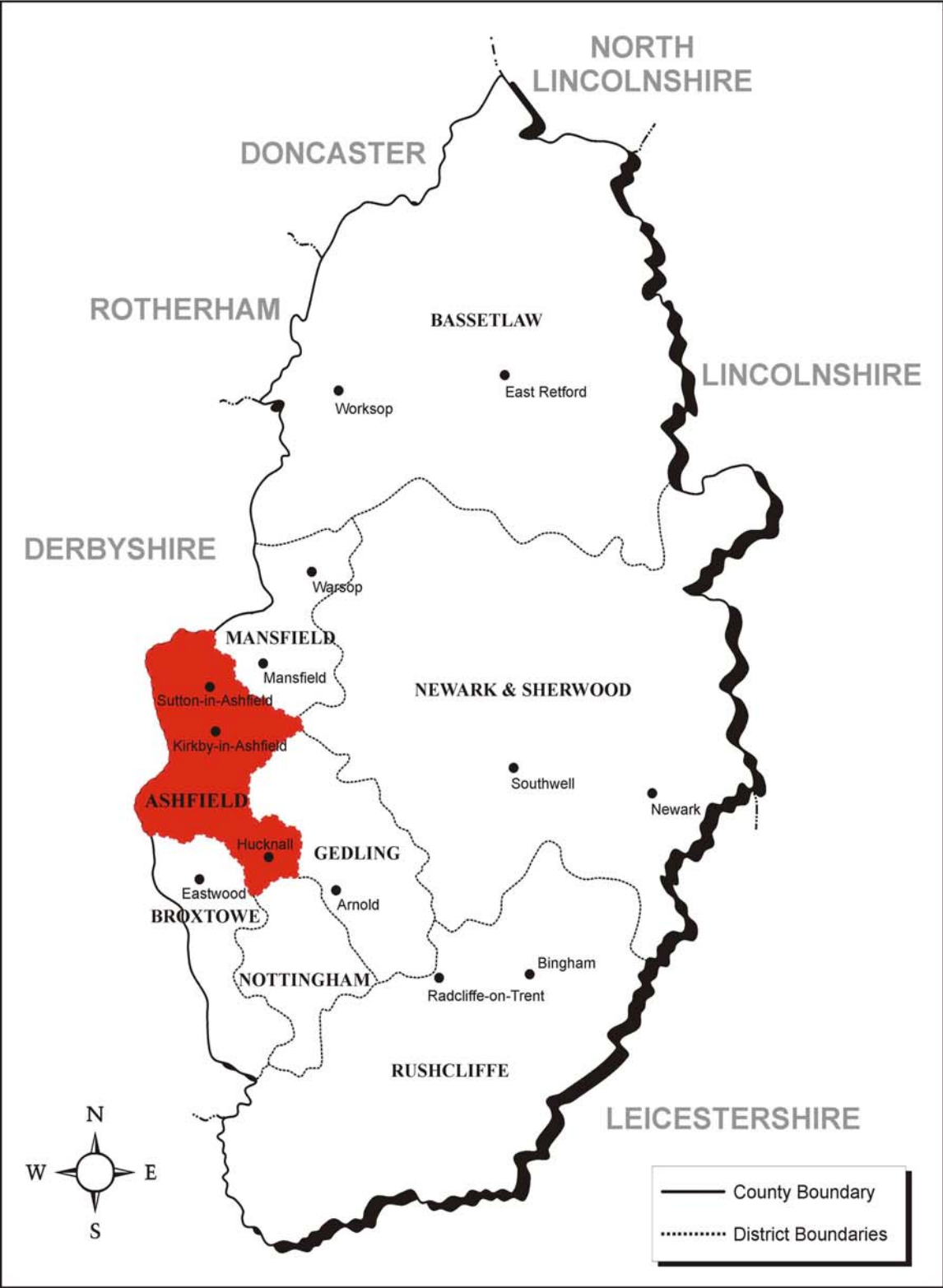

MAP B: District of Ashfield

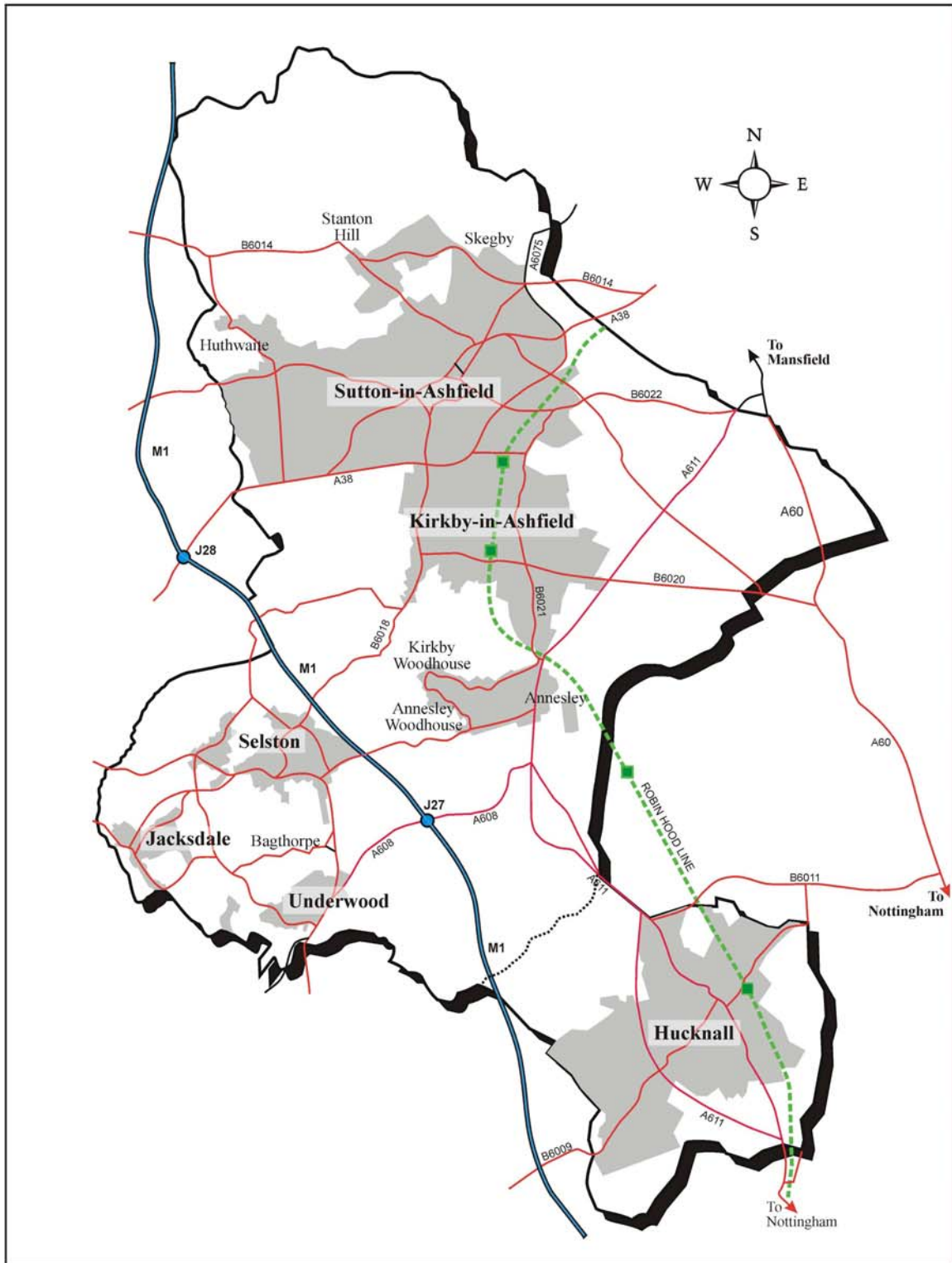

CHAPTER 3: THE ENVIRONMENT

INTRODUCTION

- 3.1 Ashfield District has a wide variety of environments from areas of poor urban quality and dereliction, particularly in its settlements, often associated with the legacy of the coalmining industry, to rural and urban areas worthy of conservation. This chapter covers environmental matters which are relevant to the Local Plan. For clarity, rural and urban considerations are dealt with separately although there is a substantial degree of overlap. The underlying sustainable development strategy of the Local Plan aims to reconcile requirements for new development with protection of the best of today's environmental assets for future generations particularly where these are irreplaceable. In line with this strategy, policies in this chapter indicate the importance that will be attached to environmental considerations in all planning decisions.

CENTRAL GOVERNMENT ADVICE

- 3.2 The Town and Country Planning Act, 1990, requires that Development Plans should include policies for the natural beauty and amenity of land and for the improvement of the physical environment. In addition the Planning (Listed Buildings and Conservation Areas) Act, 1990, provides specific protection for buildings and areas of special architectural or historic interest. Previous Government advice on environmental matters is incorporated into the White Paper produced in 1990 entitled 'This Common Inheritance'. This was the first comprehensive survey of all aspects of environmental concern and since its publication three further update reports have been released. More recent Government advice is contained within 'Planning for Communities of the Future' (Jan.'98). This document represents a first major step in the Government's drive to make our towns and cities more attractive and sustainable, and so reduce the need for development to spread into the countryside. In addition the Government has published 'Sustainable Development : The UK Strategy' (1994), which includes a position statement on the environment and current Government environmental targets and commitments. In respect of conservation and enhancement of the countryside and built environment relevant aspects include:-

- a) sustaining the character and diversity of the countryside,
- b) defending Green Belts,
- c) maintaining the character and vitality of town centres,
- d) revitalising older urban areas,
- e) safeguarding and improving the amenity of residential areas, and
- f) giving high priority to conserving the built heritage and to good design in new development.

- 3.3 Several PPGs give more detailed and practical advice on environmental matters. PPG2 'Green Belts' explains the fundamental significance of the Green Belt. PPG7 'The Countryside – Environmental Quality and Economic and Social Development' underlines the importance of the countryside and agricultural land, although acknowledging the increasing need to broaden employment opportunities in appropriate rural locations. PPG8 'Telecommunications' provides guidance on the needs and environmental considerations relating to the telecommunications industry. PPG9 'Nature Conservation' stresses the role of Local Plans in identifying nature conservation interests with a view to ensuring proper co-ordination of their protection and enhancement. PPG12 'Development Plans' stresses the importance of Development Plans being prepared to ensure that environmental issues are taken into account comprehensively and consistently so that all development decisions are taken against an overall framework that reflects environmental priorities. PPG15 'Planning and the Historic Environment' provides detailed advice on matters relating to the historic environment. PPG16 'Archaeology and Planning' gives detailed guidance on archaeological sites. PPG17 'Sport, Open Space and Recreation' outlines the value of open spaces not only as an amenity, but also as a contribution to the conservation of the natural and built environment. PPG22 'Renewable Energy' requires Local Plans to consider the contribution of renewable energy resources and to provide policy guidance for such developments.

STRUCTURE PLAN REVIEW

- 3.4 The Nottinghamshire Structure Plan Review contains a commitment to both the economic development of the County and the protection and enhancement of its environment. Chapter 1 of the Structure Plan Review includes comprehensive strategic policies relating to both urban and rural areas in the County as a whole. It covers the control of development in rural areas and the protection of certain parts of the County and specific features in particular. It also relates to a wide range of aspects of the built environment and to land reclamation.
- 3.5 The distinction between the strategic policies in the Structure Plan Review and more detailed matters to be covered in the Local Plan is not always clear cut. As a result, a number of environmental policies below either up-date or clarify strategic provisions for Ashfield. Others make specific proposals to give detailed interpretations of requirements consistent with Structure Plan Review provisions.

OTHER RELEVANT PLANS AND PUBLICATIONS

- 3.6 'Biodiversity : the U.K. Action Plan' was produced by the Government in 1994 in direct response to Agenda 21, a global programme for sustainable development. The overall goal of the UK Biodiversity Action Plan is to conserve and enhance nature conservation within the UK. The 'Local Biodiversity Action Plan for Nottinghamshire' was produced in 1998 as a means of ensuring that the U.K. Biodiversity Action Plan was translated effectively at a local level. The Plan provides a background to the initiative and explains why we should be concerned about the loss of our wild plants and animals, together with individual action plans for key species and habitats which are under threat.
- 3.7 Several other non-statutory plans and publications have been considered in the preparation of this Local Plan, particularly when allocating sites and formulating plan policy. Nationally produced plans include 'Natural Areas' (Dec.'96) produced by English Nature and 'Character Areas' (Dec.'96) produced by The Countryside Commission. Both plans deal with the preservation and enhancement of landscape features and characteristics. At a local level several strategies and plans have been produced. The Nottinghamshire Landscape Guidelines 1998, prepared by Nottinghamshire County Council, provides comprehensive and detailed information on the countryside character of Nottinghamshire. The 'Strategic Plan for Greenwood' was prepared in December 1999 by the Greenwood Community Forest Team which was established in Nottinghamshire in November 1991 and covers the whole of the Ashfield Area in addition to other parts of adjacent Districts. Community Forests are intended to provide well-wooded landscapes for wildlife, living and working, recreation and education within urban fringe areas. The 'Corridors to the Countryside Strategy' has involved a number of Local Authorities and other agencies. The aims of the strategy are to safeguard and create new opportunities for people and wildlife in Nottinghamshire wildlife corridors. The 'Nottinghamshire Heathland Strategy' is produced by the Nottinghamshire Heathland Forum which was established in 1991 and provides a framework for the conservation and enhancement of Nottinghamshire's heathland habitat. The Environment Agency produces 'Local Environment Agency Plans' (LEAPs) which are an agenda of integrated action for environmental improvement.

ENVIRONMENT OBJECTIVES

- 3.8
- a) To maintain the character of the Countryside and the openness of the Green Belt.
 - b) To identify and safeguard those parts of the District which comprise important landscape and nature conservation habitats and characteristics.
 - c) To protect trees, woodlands and hedgerows and provide opportunities for new planting and public access, particularly through the Greenwood Community Forest initiative.
 - d) To identify and safeguard those parts of the environment which display visual and historic characteristics worthy of preservation and enhancement.
 - e) To identify and encourage the reclamation of derelict land, where appropriate.
 - f) To protect the quality of surface water and ground water and protect areas from the risk of flooding.
 - g) To consider the role of renewable energy schemes and to encourage more energy efficient forms of development.

ENVIRONMENTAL ASSESSMENT

- 3.9 In determining whether planning permission should be granted for certain types of major development which may have significant environmental effects, the Council will, where appropriate, require an Environmental Assessment (EA) to be carried out in accordance with the Town and Country Planning (Environmental Impact Assessment) (England and Wales) Regulations 1999 and DETR Circular 02/99. An EA is mandatory for specific projects listed in Schedule 1 of the Regulations. Schedule 2 of the Regulations lists projects where an EA is required if the particular development proposed is judged likely to have significant environmental effects by virtue of its nature, size and location. This includes projects such as chemical, food, textile and rubber industries. Schedule 3 of The Regulations lists those aspects of the environment which may be significantly affected by a project and should be considered in assessing the need for an EA for Schedule 2 projects. County Council policy 3/I lists locations considered as sensitive or vulnerable. The Council will pay particular attention to the potential adverse environmental effects a proposed development might have on vulnerable or sensitive sites, areas or resources protected in the Local Plan and sensitive existing or proposed uses such as residential areas, schools and hospitals.

THE RURAL ENVIRONMENT

- 3.10 The Local Plan provides a set of policies for the rural areas which are consistent with and add more detail to the provisions of the Structure Plan Review. It therefore generally aims to restrain the type and location of development outside the Main Urban Areas and Named Settlements. The intention is to retain a clearly identifiable countryside which is important for its visual character, wildlife, agriculture, forestry, recreation and tourism. The policies aim both to control development generally outside built-up areas and to provide specific protection to particular features.
- 3.11 The District contains a number of areas of land which effectively form green wedges between built-up areas. Within settlements, seventeen Open Areas have been identified in Policy RC2 which are shown on the Proposals Map. In these areas development will not be permitted except for appropriate recreational uses. In rural areas substantial parts of the countryside act as important green wedges between built-up areas both within and adjoining the District. The most important of these are:-
- a) between Hucknall and Bulwell,
 - b) between Hucknall and Annesley Woodhouse, in the Misk Hills/Annesley Forest area,
 - c) between Hucknall and Bestwood Village, in the Leen Valley,
 - d) between Hucknall and Linby
 - e) between Kirkby-in-Ashfield and Annesley Woodhouse, in the Portland Park area,
 - f) in the Dumbles area, between Kirkby-in-Ashfield and South Normanton,
 - g) between Sutton-in-Ashfield and Mansfield, in particular to the east of Beck Lane, north of King's Mill Hospital, King's Mill Reservoir and the Hamilton Hill areas, and
 - h) between Stanton Hill/Skegby and Sutton-in-Ashfield, at Skegby Bottoms.
- 3.12 Each of these areas lie either within the Green Belt (policy EV1) or the Countryside (policy EV2) where strict controls apply. Many also contain specific sites of landscape, historic and nature conservation interest (policies EV4 to EV14). Hence, although a specific policy is not made in the Local Plan to protect individual green wedges between settlements, proposals which would remove their effectiveness will not be acceptable.
- 3.13 Ashfield's rural environment is divided into two parts for policy reasons. Much of the south of the District lies in the Green Belt (policy EV1) which encompasses the Nottingham conurbation. This is dealt with separately from the remaining Countryside (policy EV2) generally covering parts of the north of the District.

GREEN BELT

POLICY EV1 PERMISSION WILL NOT BE GRANTED FOR INAPPROPRIATE DEVELOPMENT IN THE GREEN BELT, EXCEPT IN VERY SPECIAL CIRCUMSTANCES.

APPROPRIATE DEVELOPMENT COMPRISES:

- a) **ENGINEERING, MINING OR OTHER OPERATIONS AND USES OF LAND WHICH PRESERVE THE OPENNESS OF THE GREEN BELT AND DO NOT CONFLICT WITH THE PURPOSES OF INCLUDING LAND IN IT;**
- b) **NEW BUILDINGS FOR THE FOLLOWING PURPOSES:**
 - i) **AGRICULTURAL AND FORESTRY;**
 - ii) **ESSENTIAL FACILITIES FOR OUTDOOR SPORT AND OUTDOOR RECREATION, FOR CEMETERIES AND FOR OTHER USES OF LAND WHICH PRESERVE THE OPENNESS OF THE GREEN BELT AND DO NOT CONFLICT WITH THE PURPOSES OF INCLUDING LAND IN IT;**
 - iii) **LIMITED EXTENSION, ALTERATION OR REPLACEMENT OF EXISTING DWELLINGS;**
 - iv) **LIMITED INFILLING WITHIN THE VILLAGES OF BAGTHORPE, NEW WESTWOOD, JUBILEE AND NEW SELSTON, SO LONG AS THERE IS NO ADVERSE EFFECT ON THE CHARACTER OF THE VILLAGE;**
- c) **THE RE-USE OF BUILDINGS.**

ALL DEVELOPMENT MUST BE LOCATED AND DESIGNED SO AS NOT TO ADVERSELY AFFECT THE PURPOSES OF THE GREEN BELT AND ITS OPENNESS

- 3.14 Policy EV1 indicates development that is appropriate in the Ashfield part of the Green Belt and reflects both the provisions of Structure Plan Review policy 3/2 and Government advice in PPG2. The purposes of including or keeping land in Green Belt are set out in paragraph 2.19 of the Strategy Chapter. The policy also complements strategy policies ST2-ST4 of this plan which concentrate development in the Main Urban Areas and allows for limited development in the Named Settlements whilst seeking to protect the countryside, particularly the Green Belt. It, however, caters for the advice contained in PPG7 which states that development in the countryside should both benefit economic activity and maintain or enhance the environment, and that many forms of development can be accommodated if the location and design is handled with sensitivity. Policy EV1 is explained in paras. 3.15 to 3.22. Paras. 3.23 to 3.25 explain the Green Belt Review process in context with policy 1/5 of the Nottinghamshire Structure Plan Review. In addition, further advice about development in Green Belts is contained in Supplementary Planning Guidance No. 2 published separately by the Council.
- 3.15 EV1(a) : Appropriate development within the Green Belt can include engineering, mining or other operations and uses of land which preserves the openness of the Green Belt and do not conflict with the purpose of including land in it. Mineral extraction often necessarily requires a rural location and need not be inappropriate development, provided that high environmental standards are maintained and that the site is appropriately restored. The responsibility for determining planning applications for mineral extraction rests with the County Council as Minerals Planning Authority. The County Council will consult the District Council on any relevant minerals planning application.
- 3.16 EV1(b) i: Many agricultural and forestry buildings are covered by The Town and Country Planning (General Permitted Development) Order 1995 and are permitted development. Where new buildings require planning permission, they should be restricted to cases where they are essential and where the need for the proposed location has been established.

- 3.17 Unless there is an overriding need, dwellings are usually best sited within existing villages or, failing that, close to existing buildings, in order to preserve the openness of the Green Belt. However, one of the few circumstances in which isolated residential development in the Green Belt may be justified is when accommodation is required to enable those employed in agriculture, or forestry to live at, or in the immediate vicinity of their place of work. The local planning authority will require a functional test to satisfy itself that a dwelling is essential, and a financial test to ensure that the enterprise is economically viable, in accordance with the guidance in PPG7, Annex 1. Paragraph 3.38 of the Plan refers to the reuse of farm buildings and issues regarding the subsequent additional need for new farm buildings.
- 3.18 EV1(b) ii: Essential facilities for outdoor sport and outdoor recreation, for cemeteries and other uses of land should be genuinely required for uses which preserve and openness of the Green Belt and do not conflict with purposes of including land in it. Possible examples of such facilities include small changing rooms or unobtrusive spectator accommodation for outdoor sports, or small stables for outdoor sports and outdoor recreation.
- 3.19 EV1(b) iii: Proposed extensions or alterations should not be disproportionate to the size of the original building. Proposals should also respect the form, bulk and general design of the original building and not adversely affect its surroundings. Replacement buildings should not be materially larger than the original building it replaces and should be designed in keeping with its surroundings. Where an existing building is derelict or is structurally unsound, permission will not be granted for its replacement unless this has resulted from accidental damage, for example by fire, or subsidence, and in the case of replacement for residential purposes, it can be demonstrated that the residential use has not been abandoned.
- 3.20 EV1(b) iv: It is not always desirable to preclude the implementation of certain infill proposals within villages in the Green Belt. The only villages 'washed over' by Green Belt are Bagthorpe, including Lower Bagthorpe, Middlebrook and New Bagthorpe, New Westwood, Jubilee and New Selston. Other smaller hamlets and outlying isolated settlements or extensions of other settlements within the Green Belt are not regarded as villages for the purpose of policy EV1(b)iv.
- 3.21 In cases where infill development in villages may be acceptable, infill will normally comprise one or two dwellings in a small gap in existing development. Not all small gaps are appropriate for infilling. Part of the character of Bagthorpe is made up of gardens, paddocks and other breaks between buildings, which is reflected in the Conservation Area designation of large parts of the village. Infill development may also not be desirable if it would consolidate groups of houses which are isolated from the main body of the village, or if it would consolidate a ribbon of development extending into the open countryside. The above principles may also apply to infill for commercial, industrial, recreational or tourism purposes providing this would be in keeping with the character of the village and would not adversely affect residential amenity.
- 3.22 EV1(c): Proposals to re-use existing buildings in the Green Belt may be acceptable, particularly where the resultant use is appropriate to the Green Belt such as for agriculture or forestry. Preference will be given where the re-use of a building would assist in the diversification of the rural economy through the provision of employment, recreational or tourism uses. The re-use of a building for residential purposes may be acceptable if it is not possible to find an alternative appropriate use. Proposed new uses should not have a materially harmful impact on the openness of the Green Belt particularly through their extension or the associated uses of surrounding land, for example, extensive hardstanding, car parking, boundary walling/fencing or extensive external storage. Further guidance on the re-use of rural buildings is provided in policy EV3 and also Supplementary Planning Guidance No. 5 published separately by the Council.
- Green Belt Boundaries
- 3.23 PPG2 stresses the essential permanence of Green Belts and that their protection must be maintained as far as can be seen ahead. It also states that proposals affecting Green Belts in Structure or Local Plans should be related to a timescale longer than normally adopted for

other aspects of the Plan. PPG2 explains that, where existing Local Plans are being revised and up-dated, existing Green Belt boundaries should not be changed unless alterations to the Structure Plan have been approved or other exceptional circumstances exist which necessitate such revision.

- 3.24 As previously detailed within para. 2.17 of the plan strategy, the Secretary of State for the Environment recognised in 1991 that, by the (then) Structure Plan end-date of 2001, the land supply situation in Greater Nottingham could be such that further development may only be possible by using land currently allocated for open space or by pushing out into the Green Belt. Therefore, in order to meet these requirements it was agreed that Green Belt boundaries should be reviewed by the appropriate District Councils in Local Plans during the Structure Plan period.
- 3.25 A comprehensive review of all Green Belt boundaries has subsequently been undertaken involving detailed site surveys of all existing boundaries identified in the adopted Ashfield Local Plan. The main aims of this review were firstly, in light of the scale of housing and employment land required in the Structure Plan Review and the limited scope for accommodating this in the urban areas, to identify locations adjacent to the Main Urban Areas where development would be appropriate to meet projected needs to 2011. The identification of these sites is in accordance with the 'Sequential Approach to site selection' referred to in paragraphs 2.35 and 2.36 of the Strategy Chapter. Secondly, a review of detailed urban area and village boundaries was intended to reveal any anomalies that were present from the original Green Belt survey and to ensure a consistent approach was adopted for all boundaries. An overriding requirement of this exercise was to ensure that where any changes were proposed, the subsequent Green Belt boundaries could be defended from further development for the foreseeable future. Details of the methodology used in the Green Belt review and site plans showing the proposed amendments to the Green Belt and Countryside boundaries are included in Technical Paper No. 2: 'Green Belt and Countryside Review'.

THE COUNTRYSIDE

POLICY EV2

IN THE COUNTRYSIDE PERMISSION WILL ONLY BE GIVEN FOR APPROPRIATE DEVELOPMENT. DEVELOPMENT MUST BE LOCATED AND DESIGNED SO AS NOT TO ADVERSELY AFFECT THE CHARACTER OF THE COUNTRYSIDE, IN PARTICULAR ITS OPENNESS.

APPROPRIATE DEVELOPMENT COMPRISES:

- a) **RURAL USES, INCLUDING AGRICULTURE, FORESTRY, MINERAL EXTRACTION AND WASTE DISPOSAL TO RECLAIM MINERAL WORKINGS,**
- b) **OUTDOOR SPORT, OUTDOOR RECREATIONAL AND TOURISM USES,**
- c) **CEMETERIES AND UTILITY INSTALLATIONS REQUIRING A RURAL LOCATION,**
- d) **NEW BUILDINGS WHICH ARE ESSENTIAL FOR USES APPROPRIATE TO THE COUNTRYSIDE AND THE NEED FOR THE PROPOSED LOCATION HAS BEEN ESTABLISHED,**
- e) **RE-USE OF EXISTING BUILDINGS,**
- f) **REPLACEMENT, ALTERATION OR EXTENSION OF EXISTING BUILDINGS WHERE THE RESULTANT FORM, BULK AND GENERAL DESIGN IS IN KEEPING WITH THE BUILDING, WHERE RETAINED, AND ITS SURROUNDINGS,**
- g) **INFILL DEVELOPMENT WHICH DOES NOT HAVE AN ADVERSE EFFECT ON THE SCALE AND CHARACTER OF THE AREA,**
- h) **WITHIN THE VILLAGES OF FACKLEY AND TEVERSAL, DEVELOPMENT WHICH DOES NOT HAVE AN ADVERSE EFFECT ON THE CHARACTER OF THE VILLAGE.**

- 3.26 Policy EV2 shows the types of development which are appropriate in the Countryside areas not specifically designated as Green Belt. It accords with Structure Plan Review policy 3/1 'Control of development in the Countryside' and supports the intention to locate most new residential and employment development within urban areas. It, however, caters for the advice contained in PPG7 which states that development in the Countryside should both benefit economic activity and maintain or enhance the environment and that many forms of development can be accommodated if the location and design is handled with sensitivity. The policy also complements strategy policies ST2 - ST4 which aim to concentrate development in the Main Urban Areas and provide for limited growth in Named Settlements as a corollary generally to protecting remaining areas from development.
- 3.27 EV2(a) : The types of uses appropriate in the Countryside are largely the same as those appropriate to a Green Belt, as outlined in policy EV1. Waste disposal operations may take place in rural locations as a means to use former mineral workings as voids for landfill, although this will be a matter for consideration by the Waste Authority. The responsibility for determining planning applications for mineral extraction rests with the County Council as Minerals Planning Authority. The County Council will consult the District Council on any relevant minerals planning application.
- 3.28 EV2(b) : Certain recreational uses, such as country parks, golf courses and playing fields, need extensive areas of land, but generally preserve the openness of the Countryside. Such uses would be appropriate on suitable sites within the Countryside subject to considerations relating to loss of the best and most versatile agricultural land (see policy EV9). Certain tourism uses, can also be appropriate provided that they are designed and located in a way which complements and does not adversely affect the character of the Countryside.
- 3.29 EV2(c) : Cemeteries are acceptable in the Countryside, being large space users that are substantially open in character. Other appropriate development may include that for public utilities, such as the extension or construction of electricity transmission lines and pylons, railway installations, pumping stations and water reclamation works, which may need to be located in the Countryside.
- 3.30 EV2(d) : New buildings will be restricted in the Countryside (outside villages) to cases where it is essential for an appropriate Countryside use and the need for the proposed location has been established. Any new building should be at a scale which preserves the openness of the Countryside. One of the few circumstances in which isolated residential development in the Green Belt/Countryside may be justified is when accommodation is required to enable those employed in agriculture, or forestry to live at or in the immediate vicinity of their place of work. In such cases the local planning authority will require a functional test to satisfy itself that a dwelling is essential, and a financial test to ensure that the enterprise is economically viable, in accordance with the guidance in PPG7, Annex 1.
- 3.31 EV2(e) : To reflect PPG7, this policy does not restrict the nature of the new use to which existing buildings can be put. However, preference will be given where the re-use of a building would assist with the diversification of the rural economy for employment, recreational or tourism purposes. The re-use of a building for residential purposes may be acceptable if it is not possible to find an alternative appropriate use. To be acceptable any such proposal would need to be strictly sympathetic with the character of the Countryside, in particular its openness. Further guidance on the re-use of rural buildings is provided in policy EV3 and also Supplementary Planning Guidance No.5 published separately by the Council.
- 3.32 EV2(f): Proposals to replace, alter or extend buildings can be acceptable where the form, bulk and general design is in keeping with the original building, where retained, and its surroundings. Replacement buildings should not be materially larger than the original building it replaces and should be designed in keeping with its surroundings. Extensions or alterations should not be disproportionate to the size of the original building.
- 3.33 EV2(g) : New dwellings will not normally be permitted in the open Countryside, although in some cases sensitive infilling may be acceptable within small settlements and hamlets. Infill will normally comprise one or two dwellings in a small gap in existing development. Not all small

gaps are appropriate for infilling where, for example, they contribute towards the openness of the Countryside. Regard should also be made to the scale and character of the area when assessing a development. The above principles may also apply to infill for commercial, industrial, recreational or tourist purposes providing this would be in keeping and with the scale character of the area and would not adversely affect residential amenity.

- 3.34 EV2(h) : Fackley and Teversal are the only villages within the Countryside and are considered suitable for small scale infill development where appropriate. Teversal, however, is designated as a Conservation Area and part of the character of Teversal is made up of gardens, open spaces and open breaks between buildings. Whilst new development will generally be resisted in Teversal, some limited scope exists for the re-use of certain existing farm buildings within the village.

Countryside Boundaries

- 3.35 A comprehensive review of all Countryside boundaries has been undertaken involving detailed site surveys of all existing boundaries identified in the adopted Ashfield Local Plan. The review was carried out using the same methodology as for the Green Belt review. A summary of the exercise is explained within paragraph 3.25, and details of the full methodology, together with site plans showing the proposed amendments, are included in Technical Paper No. 2: 'Green Belt and Countryside Review'.

RE-USE OF BUILDINGS IN THE GREEN BELT AND COUNTRYSIDE

POLICY EV3 THE RE-USE OF BUILDINGS WITHIN THE GREEN BELT OR THE COUNTRYSIDE WILL BE PERMITTED WHERE:-

- a) **THEIR FORM, BULK AND GENERAL DESIGN ARE IN KEEPING WITH THE SURROUNDINGS,**
- b) **THE CHARACTER OF THE BUILDING IS RETAINED,**
- c) **THE BUILDING IS OF PERMANENT AND SUBSTANTIAL CONSTRUCTION AND IS CAPABLE OF CONVERSION WITHOUT MAJOR OR COMPLETE RECONSTRUCTION,**
- d) **THE PROVISION OF A CURTILAGE WOULD NOT ADVERSELY AFFECT THE OPEN CHARACTER OF THE GREEN BELT OR COUNTRYSIDE,**
- e) **IT WOULD NOT RESULT IN AN UNACCEPTABLE PROLIFERATION OF REPLACEMENT FARM BUILDINGS.**

- 3.36 Development in the Green Belt and Countryside is strictly controlled by policies EV1 and EV2. Where it is appropriate in principle and involves the re-use or adaptation of existing buildings it is important to ensure that the overall character and quality of a building is not lost. The above criteria provide specific requirements for such re-uses.

- 3.37 A proposal for re-use of an existing building must ensure that the resultant form, bulk and general design of the building is in keeping with the surroundings and that the character of the building is retained. PPG7 paragraphs 3.14 to 3.17 and Annex G refer to the re-use and adaptation of rural buildings. Buildings which are not of permanent and substantial construction and are not capable of re-use without major or complete reconstruction are unsuitable. In addition, buildings should be physically capable of providing adequate accommodation without the need for significant extensions which would adversely affect the character of the building or its locality. The provision of a garden area to serve a converted building can also have an adverse impact on the local environment due to its position, extent, boundary treatment and the erection of additional buildings such as garages, sheds and greenhouses. Similarly where commercial or industrial uses are concerned, the provision of storage, hardstanding, car parking or boundary walling can have an adverse affect on its surroundings.

- 3.38 The re-use of existing agricultural buildings can result in the need for new farm buildings elsewhere on the farm. In certain areas new farm buildings can adversely affect the local and wider landscape and it may be appropriate to control their proliferation by using planning

conditions or negotiating a planning obligation. Detailed guidance on the re-use of rural buildings to residential use is contained in Supplementary Planning Guidance No. 5 published separately by the Council.

MATURE LANDSCAPE AREAS

POLICY EV4 DEVELOPMENT WHICH DOES NOT ADVERSELY AFFECT THE CHARACTER AND QUALITY OF MATURE LANDSCAPE AREAS WILL BE PERMITTED.

Existing Mature Landscape Areas are listed below and shown on the Proposals Map:

Rural Area

Ra	SOUTH OF HUCKNALL
Rb	MISK HILLS
Rc	UNDERWOOD
Rd	BAGTHORPE
Re	JACKSDALE
Rg	ANNESLEY
Rh	KIRKBY PARK
Ri	HOLLINWELL
Rj	DUMBLES
RI	COXMOOR/KINGS MILL
Rm	HUTHWAITE/SPRINGWOOD
Rn	SKEGBY BOTTOMS
Ro	TEVERSAL
Rp	DOVEDALE/HARDWICK PARK
Rq	PAPPLEWICK

- 3.39 The County Council has undertaken a Countryside Appraisal project to provide a strategic, countryside overview and information base for the landscape of Nottinghamshire. The Appraisal is an important resource designed to be used as a tool for landscape protection, conservation, management and enhancement. One of the main elements of the Countryside Appraisal is the identification of Mature Landscape Areas (MLAs) through a formal assessment of the qualities of the local countryside in accordance with PPG7. Survey work identifying MLAs was initially published in 1994 and subsequently reviewed during 1999.
- 3.40 MLA's are a local countryside designation, to identify and protect valuable and vulnerable parts of Nottinghamshire's Landscape which have remained relatively unchanged over time. They are located in areas least affected by urban development, mineral extraction, extensive commercial forestry or intensive modern agricultural practices resulting in the permanent loss of important landscape features. The MLA review methodology has adopted a more consistent approach to the inclusion of arable land. Whereas previously all areas of intensive arable land were excluded because it was considered to indicate significant change in the landscape qualities that were being assessed, it is now recognised that arable areas which retain their basic structure of field boundaries, tree cover and other important features, for example field ponds, may also be included.
- 3.41 Policies EV1 and EV2 explain the limited types of development which may be appropriate in the rural parts of the District, whether defined as Green Belt or Countryside. Policy EV4 identifies 15 Mature Landscape Areas (MLA) in the District, as defined by Nottinghamshire County Council. Under policy EV4, should a proposal be acceptable in principle based upon policies EV1 or EV2, the actual form of the development will need to have regard to the particular landscape characteristics of importance to that locality and be in sympathy with and complementary to those characteristics. This approach reflects Government advice indicating that Local Plans are required to include policies on the conservation of the natural beauty and amenity of land and to determine specific policies reflecting different types of countryside. During the plan period the list of MLAs may be affected by the designation of new sites, the

deletion of existing sites due to changes in land use management or through the modification of boundaries following a review.

SITES OF SPECIAL SCIENTIFIC INTEREST

POLICY EV5 PROPOSALS FOR DEVELOPMENT IN, OR LIKELY TO AFFECT, SITES OF SPECIAL SCIENTIFIC INTEREST (SSSI) WILL BE SUBJECT TO SPECIAL SCRUTINY. WHERE SUCH DEVELOPMENT MAY HAVE AN ADVERSE EFFECT, DIRECTLY OR INDIRECTLY, ON THE SSSI IT WILL NOT BE PERMITTED UNLESS THE REASONS FOR DEVELOPMENT CLEARLY OUTWEIGH THE NATURE CONSERVATION VALUE OF THE SITE ITSELF AND THE NATIONAL POLICY TO SAFEGUARD THE NATIONAL NETWORK OF SUCH SITES.

WHERE DEVELOPMENT IS PERMITTED, CONSIDERATION WILL BE GIVEN TO THE USE OF PLANNING CONDITIONS OR PLANNING OBLIGATIONS TO ENSURE THE PROTECTION AND ENHANCEMENT OF THE SITE'S NATURE CONSERVATION INTEREST.

Existing Sites of Special Scientific Interest are listed below and shown on the Proposals Map:-

Sites of Special Scientific Interest

Ra	BULWELL WOOD, HUCKNALL
Rb	FRIEZELAND GRASSLAND, UNDERWOOD
Rc	BAGTHORPE MEADOWS
Rd	ANNESLEY WOODHOUSE QUARRY
Re	BOGS FARM QUARRY, ANNESLEY WOODHOUSE
Rf	KIRKBY GRIVES
Rg	TEVERSAL PASTURES
Rh	TEVERSAL TO PLEASLEY RAILWAY
Ri	DOVEDALE WOOD

3.42 Policy EV5 reflects the overall provisions of Structure Plan Review policy 3/7 in relation to important nature conservation sites in the County and affords specific protection to a variety of individual sites in the District. Careful consideration will be given to proposed developments in the vicinity of SSSIs to ensure these will not adversely affect the protected site. Development proposals in or likely to affect SSSIs must be subject to special scrutiny.

3.43 The nine SSSIs (policy EV5 Ra-Ri) are marked on the Proposals Map. During the Local Plan period the list of SSSIs may be affected by the notification of new sites, the deletion of existing sites or through the modification of boundaries following a review.

LOCAL NATURE RESERVES AND SITES OF IMPORTANCE FOR NATURE CONSERVATION AND GEOLOGICAL SIGNIFICANCE

POLICY EV6 DEVELOPMENT WHICH ADVERSELY LOCAL NATURE RESERVES OR SITES OF IMPORTANCE FOR NATURE CONSERVATION OR GEOLOGICAL SIGNIFICANCE WILL ONLY BE PERMITTED WHERE:-

- a) PROVISION IS MADE WITHIN THE DEVELOPMENT FOR THE PROTECTION OF FEATURES OF NATURE CONSERVATION OR GEOLOGICAL SIGNIFICANCE, OR**
- b) THE DEVELOPMENT CANNOT BE LOCATED ELSEWHERE. IN THE CASE OF NATURE CONSERVATION FEATURES ADEQUATE PROVISION IS MADE FOR THE CREATION OF SIMILAR HABITATS, WHERE FEASIBLE, PREFERABLY IN**

**THE LOCALITY, NEGOTIATED AND SECURED BY A
PLANNING CONDITION OR PLANNING OBLIGATION.**

Existing Local Nature Reserves are listed below and shown on the Proposals Map:

Ra	PORTLAND PARK, KIRKBY
Rb	TEVERSAL TO PLEASLEY RAILWAY
Rc	JACKSDALE
Rd	BENTINCK BANKS (PART)

Existing Sites of Importance for Nature Conservation or Geological Significance are listed in Appendix 1 and shown on the Proposals Map.

- 3.44 Sites of Importance for Nature Conservation and Geological Significance (SINCs) identified on the Proposals Map relate to a survey carried out by the Nottinghamshire Biological and Geological Records Centre, on behalf of the Nottinghamshire Wildlife Audit Steering Group, in 1998. The survey identified a list of SINCs, which represents a statement of the location and extent of the most important natural history sites in the area and stems from detailed records prepared in recent years from botanical, zoological and geological data. SINCs will be subject to regular review and updating to take account of new developments and to identify new sites.
- 3.45 Local Nature Reserves (LNRs) have an important part to play in biodiversity conservation, and in the protection and interpretation of wildlife habitats and natural features. LNRs can also make an important contribution to the quality of the environment for local people, and provide opportunities for study and education. Each of the four LNRs (policy EV6 Ra-Rd) are marked on the Proposals Map and are contained within or about a Site of Special Scientific Interest (policy EV5).
- 3.46 The maintenance of a sustainable environment for future generations relies on the protection of a critical stock of habitats throughout the rural and built environments. The LNR and SINC sites in the District should be retained as part of this stock. Development likely to affect such sites will therefore need to be carefully considered. In Green Belt and Countryside locations, where development is strictly controlled, it should generally be possible to ensure that LNRs and SINCs are avoided or protected. In urban locations, where development is to be concentrated, there will inevitably be conflict with some LNRs and SINCs. Provision can often be made to protect the features of nature conservation or geological significance within the development and retain them in-situ. Planning conditions may be imposed relating to the design, landscaping, timing and operational methods of the development. Where it is not possible to retain habitats in-situ it may be possible to create alternative new habitats to replace those lost to development. This will be a matter for negotiation between the Local Planning Authority and the developer and will be secured, where feasible, through the use of a planning condition or planning obligation which will also address the long term management of the habitat. LNRs and SINCs are shown on the Proposals Maps and listed above.
- 3.47 Where it is not possible to protect a LNR or SINC site through mitigation, a decision has to be made as to whether the development is important enough to allow the removal of a site or part of a site. This decision should be based upon the relative value of the site compared to the value of the new development. There are a number of factors which must be considered including the rarity of the nature conservation feature, the significance of the feature in light of what proportion it is of national, regional or local resource and the value of the development.

SITES/BUILDINGS SUPPORTING SPECIES PROTECTED BY LAW

POLICY EV7 DEVELOPMENT WHICH WOULD ADVERSELY AFFECT SITES OR BUILDINGS SUPPORTING SPECIES PROTECTED BY LAW WILL ONLY BE PERMITTED WHERE:-

- a) PROVISION IS MADE WITHIN THE PROPOSED DEVELOPMENT TO AVOID OR MINIMISE DISTURBANCE TO THE SPECIES, OR**
- b) PROVISION IS MADE FOR THE CREATION OF SIMILAR HABITATS, WHERE FEASIBLE, PREFERABLY WITHIN THE LOCALITY, NEGOTIATED AND SECURED BY A PLANNING OBLIGATION.**

3.48 Threatened wildlife species are protected through the Wildlife and Countryside Act 1981, as amended, the Protection of Badgers Act 1992, the Conservation (Natural Habitat & c.) Regulations 1994 (schedules 2 and 4) and other legislation relating to specific species. Often these will be found in areas or sites already protected in the Local Plan, including SSSIs, LNRs, MLAs or SINCs but can be found elsewhere. Where such species are known or suspected to exist, expert advice will be sought from the appropriate statutory body to ensure that species are adequately taken into account in any proposed development. The Authority may subsequently require the applicant to undertake a survey to identify the types of protected species present and the location and nature of their habitats. Provision can often be made to avoid or minimise disturbance to species and their habitats within the development and retain them in-situ. Planning conditions may be imposed relating to the design, landscaping, timing and operational methods of the development and these can often be identified in the site survey. On all proposed development sites, it will nearly always be preferable to accord with criteria (a) of policy EV7. Where it is not possible to retain the species and their habitats in-situ, as a last resort provision should be made, where feasible, for the creation of similar habitats preferably in the locality and this will be negotiated and secured through a planning obligation.

3.49 English Nature has acknowledged within their 1996 publication 'Local Planning and Wildlife Law', that if it is not possible to keep a protected species on site through mitigation, a decision has to be made as to whether the development is important enough to allow their removal and the destruction of their habitat. This country's wildlife must be seen as one of its resources and, as such, this decision should be based upon the relative value of a resident population of a protected species compared to the value of the new development. There are a number of factors which must be considered including the rarity of the species, the significance of the population in light of what proportion it is of national or regional populations and the value of the development.

TREES AND WOODLANDS

POLICY EV8 DEVELOPMENT WHICH ADVERSELY AFFECTS TREES WORTHY OF RETENTION, INCLUDING WOODLAND AND INDIVIDUAL TREES, WILL NOT BE PERMITTED. WHERE TREES ARE LOST AS A RESULT OF DEVELOPMENT, REPLACEMENT OR MITIGATING PLANTING WILL BE REQUIRED.

Existing Ancient Woodland sites are listed in Appendix 2 and shown on the Proposals Map

3.50 Trees and woodlands make an important contribution to the quality of particular areas and are significant both as landscape features and individual habitats and can be of recreational value. Wherever possible the Authority will protect existing trees within development sites and will introduce Tree Preservation Orders as necessary. Existing trees and woodlands will be expected to remain within development proposals and be complemented by new landscaping schemes. Where trees are lost as a result of development, replacement trees or mitigating planting will be required.

- 3.51 An Ancient Woodland is an area which has had continuous cover of native trees and plants since at least 1600 A.D., neither having been cleared nor extensively replanted since then. The date is adopted as marking the time when forestry began to be widely adopted and when evidence in map form began to become available. Nine Ancient Woodland sites have been identified by English Nature within Ashfield.

HEDGEROWS

- 3.52 Hedgerows are the most traditional types of field boundaries in many areas and make an important contribution to the landscape of the District. They are often of considerable historic and wildlife interest and, particularly in the case of older hedgerows, often contain a great diversity of plant and wildlife species. As such, the loss of hedgerows from the countryside landscape has been a continuing cause for concern.
- 3.53 On the 1st June 1997 the Hedgerows Regulations, 1997 came into force under section 97 of the Environment Act, 1995. They introduced new arrangements for local planning authorities to protect "important" hedgerows in the countryside, by controlling their removal through a system of notification. The regulations set out criteria that must be used by the local planning authority in determining which hedgerows are "important". The criteria relate to the value of hedgerows from an archaeological, historical, landscape and wildlife perspective. There is a strong presumption that "important" hedgerows and other hedgerows, where possible, will be protected and wherever possible incorporated into open space and landscaping proposals for new development.

GREENWOOD COMMUNITY FOREST

- 3.54 The Greenwood Community Forest was established in Nottinghamshire in November, 1991. The whole of Ashfield lies within the Greenwood Community Forest, as shown on the proposals map, and is expected to remain the central area for development of the Forest. Community Forests are intended to provide well-wooded landscapes for wildlife, living and working, recreation and education within urban fringe areas. Accessibility is a key component in all proposed Community Forest schemes and full consideration will be given to the potential to create community routeways within new woodlands and open spaces. It is anticipated that over time a network of woodlands will be developed through privately funded, Local Authority and community based schemes. Such proposals will need to have regard to nature conservation and Mature Landscape Areas.
- 3.55 Ashfield District Council has carried out a number of schemes contributing to the Greenwood Community Forest including Brierley Forest Park, a major public open space between Sutton-in-Ashfield, Huthwaite and Stanton Hill. This 145 hectare parkland includes extensive areas of tree planting, wetlands and wildflower meadow together with a large trail network and visitor centre. Privately owned land to the south and east of Brierley Forest Park comprises an important part of the setting of the park and as such will continue to be protected as part of the countryside.
- 3.56 The District and County Council are continuing to identify new opportunities to develop the Greenwood Community Forest further particularly through the reclamation and restoration of derelict land. A scheme is currently being carried out to create a new forest on the former Silverhill Colliery site and opportunities may exist in connection with Bentinck Colliery in the future. A major new parkland will also be created through the phased restoration of the Sutton landfill site. The recent acquisition of the historic water gardens associated with Skegby Hall, will offer a further opportunity to link Brierley Forest Park with an extended trails network to the east. Further opportunities for public access may exist within the arboretum at Annesley Hall, together with the possibility for a new link westwards towards Weavers Lane. There may also be scope to extend the arboretum southwards into the parkland, which surrounds the Hall, and create a public link around the parkland.
- 3.57 Private developments can also contribute significantly to the Greenwood Community Forest through woodland planting and the sympathetic design of areas of open space. Developers of large sites will be expected to contribute to the development of the Greenwood Community Forest particularly incorporating substantial areas of new woodland into proposals where appropriate. Developers of residential sites comprising less than two hectares in size, may be

asked either to incorporate small woodland features into the site or contribute towards off site provision of community woodlands. This matter is covered in policy HG6. Preference will be given to the planting of native tree species in new developments.

AGRICULTURAL LAND

POLICY EV9 DEVELOPMENT OF THE BEST AND MOST VERSATILE AGRICULTURAL LAND (GRADES 1, 2 AND 3a) WILL ONLY BE PERMITTED WHERE:-

- a) THERE ARE NO REALISTIC OPPORTUNITIES FOR ACCOMMODATING THE DEVELOPMENT ON PREVIOUSLY-DEVELOPED SITES AND ON LAND WITHIN EXISTING URBAN AREAS; AND**
- b) THERE ARE NO REALISTIC OPPORTUNITIES FOR ACCOMMODATING THE DEVELOPMENT ON POORER QUALITY AGRICULTURAL LAND (EXCEPT WHERE OTHER SUSTAINABILITY CONSIDERATIONS INDICATE OTHERWISE).**

3.58 It is important to safeguard the best and most versatile agricultural land which is most significant in terms of the national agricultural interest as acknowledged in PPG7. The Agricultural Land Quality Classification system, prepared by the Ministry of Agriculture, Fisheries and Food, contains five grades (1-5) with the middle grade split into 3a and 3b. Higher grade agricultural land (i.e. Grades 1, 2 and 3a) is the best and most versatile land and is a national resource for the future. No Grade 1 land has been identified in Ashfield District, although future detailed investigations may establish its existence. There are areas of Grades 2 and 3a, mostly falling either within the Green Belt or Countryside, and therefore already subject to strict control of development. However, development which is acceptable in such areas should avoid the loss of the best and most versatile agricultural land except where there are no realistic opportunities for accommodating the development on previously-developed sites and on land within the existing urban areas, and there are no realistic opportunities for accommodating the development on poorer quality agricultural land (except where other sustainability considerations indicate otherwise). Examples of other sustainability considerations might include the importance for biodiversity, the quality and character of the landscape, the amenity value or heritage interest, accessibility to infrastructure, workforce and markets and the protection of natural resources, including soil quality. Some of these qualities may be recognised by a statutory wildlife, landscape, historical or archaeological designation. However, it should be noted that once agricultural land is developed, even for 'soft' uses such as golf courses, its return to best quality agricultural use is seldom practical.

3.59 Some sites allocated for development elsewhere in this Local Plan may partially affect land of Grade 2 or 3a quality. The impact of the loss of such land has been taken into account when considering the allocation of these sites. In such cases it has been determined that the importance of the sites for other locational reasons has outweighed the impact of the loss of the farmland involved.

THE BUILT ENVIRONMENT

3.60 The three Main Urban Areas in the District, Hucknall, Kirkby-in-Ashfield and Sutton-in-Ashfield, each contain a range of built environments including substantial areas of nineteenth and early twentieth century terrace housing, inter-war estates and extensive areas of modern development. More recently, sizeable industrial estates have been located within each of the three towns, as the traditional industries of coalmining and textiles have declined. The decline of traditional industries has left areas of derelict and vacant land, which required assistance to make the sites suitable for an appropriate end use. In this respect both the District and County Council, with grant assistance from English Partnerships, have successfully reclaimed many derelict areas in the District relating mainly to former colliery and railway land.

3.61 Many of the smaller settlements, particularly Jacksdale, Selston and Underwood, have also experienced substantial expansion, often in the form of post-war ribbon development and more

recently through the introduction of modern housing estates led by the demand for 'commuter' development. However, certain parts of these settlements retain their original character and charm which, together with their close proximity to the countryside, make them attractive places to live.

- 3.62 The protection of the best parts, and improvement of the more rundown areas of the built environment are high priorities of the Authority. There are four designated Conservation Areas and over 80 buildings considered to be of architectural and historic interest in the District. In the remainder of the urban area the Authority has undertaken environmental improvements, concentrating particularly in the main shopping areas, on land adjacent to main public highways and on derelict and poorly maintained sites. On new developments the Authority will continue to require a high standard of design. Supplementary Planning Guidance relating to various topics has been published separately by the Council and advises developers of design standards required.

CONSERVATION AREAS

POLICY EV10 DEVELOPMENT IN CONSERVATION AREAS WILL ONLY BE PERMITTED WHERE:-

- a) **IT PRESERVES OR ENHANCES THE CHARACTER OR APPEARANCE OF THE AREA, OR ITS SETTING.**
- b) **IN THE CASE OF DEMOLITION OR PARTIAL DEMOLITION IT CAN ALSO BE DEMONSTRATED THAT THE BUILDING IS BEYOND ECONOMIC REPAIR, VIABLE ALTERNATIVE USES CANNOT BE FOUND, OR REDEVELOPMENT WOULD PRODUCE SUBSTANTIAL BENEFITS FOR THE COMMUNITY THAT WOULD OUTWEIGH THE BUILDING'S LOSS.**
- c) **REDEVELOPMENT FOLLOWING DEMOLITION IS UNDERTAKEN WITHIN AN AGREED TIMESCALE.**

Existing Conservation Areas are listed below and shown on the Proposals Map:

Kirkby-in-Ashfield

Ka KIRKBY CROSS

Rural Area

Ra LOWER BAGTHORPE

Rb TEVERSAL

Rc NEW ANNESLEY

- 3.63 The Authority is required to identify those parts of the District considered to have special architectural and historic importance and to designate such areas as Conservation Areas. Four Conservation Areas have been designated, at Lower Bagthorpe, Kirkby Cross, Teversal and New Annesley, in areas which comprise groups of buildings of historic architectural or local interest. The designation of a Conservation Area does not preclude development from taking place, but it does allow for a greater control of any proposed development. Advice on Conservation Areas is contained in PPG15 which lays down the principal considerations for permitted development, demolition of buildings and special provision for trees in Conservation Areas. Conservation Area appraisals are dealt with under separate legislation and therefore a review of existing Conservation Area boundaries and an assessment of other areas for possible designation will be undertaken in the near future, separate from this plan.

- 3.64 A key consideration in assessing development proposals will be the effect new development would have on the character and appearance of these areas and in particular whether they assist in both preserving or enhancing their special character. New development should

respect the character of the existing architecture in terms of scale, grouping and materials. The overall character of the area will also be an important consideration, applying to features such as walls, paving, verges, trees, street furniture and spaces between dwellings which can be as significant as the buildings themselves. Outline planning applications will not normally be acceptable for development in Conservation Areas. Development control policies and Supplementary Planning Guidance provide further advice on specific requirements for new developments in general. In addition, proposals to lop, top or fell trees in these areas which, although not specifically comprising development, will only be acceptable with the prior approval of the Authority.

- 3.65 Where a development proposal involves the demolition or partial demolition of a building in a conservation area consideration will be given to the contribution of the existing building to the character and appearance of the area. Generally buildings should be retained where they make a positive contribution in this respect. However, there may be cases where the removal or replacement of a building would benefit the character or appearance of an area. The condition of the existing building and the potential for viable alternative uses will be relevant considerations as will the potential benefits of redevelopment for the community compared with the effects the building's loss would have on the Conservation Area. All proposals for demolition and redevelopment will need to include full and detailed plans indicating what is proposed for the site after demolition. To ensure that sites do not remain undeveloped for long periods of time, conditions may be imposed on planning permissions to ensure that redevelopment occurs within specified time limits. This may require that demolition does not take place until a contract for the carrying out of work of redevelopment has been made and planning permission for those works granted.
- 3.66 Kirkby Cross Conservation Area (EV10Ka) was designated in 1975 and is located around a busy junction at Church Street/Sutton Road/Chapel Street and St. Wilfrid's Church. The remains of a fourteenth century village dressed stone cross is situated at the junction and is a listed structure and ancient monument. The area consists of a number of farm buildings, some of which are listed, constructed in local stone with either clay pantiles or tiled roofs. Modern development has been allowed more recently within the area which has detracted from its overall appearance. Future development will need to be more sympathetically designed to complement the more traditional buildings.
- 3.67 Lower Bagthorpe Conservation Area (EV10Ra) was also designated in 1975 and extended in 1986. It is a Green Belt village which, for the most part, straddles Bagthorpe Brook. The area is characterised by a series of farm buildings and dwellings located alongside the highway running through the valley containing the Bagthorpe Brook. The dispersed nature of developments in a generally mature landscape setting is an essential component of the special character of the area.
- 3.68 Teversal Conservation Area (EV10Rb) comprises an attractive small village, almost unspoilt by modern development, containing a number of important listed buildings and a fine avenue of lime trees. The extensive use of local stone in both buildings and boundary walls and the use of traditional roofing materials add to the special character of the area. Whilst new development will generally be resisted, some limited scope exists for the re-use of certain existing farm buildings within the settlement, although great care will be needed to ensure that any development or conversion is entirely sympathetic to the local vernacular.
- 3.69 New Annesley Conservation Area (EV10Rc) was designated in March 1999 and comprises a mid 19th Century colliery village. The Conservation Area includes Moseley Farm which dates back to the 17th Century, the colliery terraces (also known as the colliery rows) and their associated gardens, the colliery site itself and six original staff houses located near the colliery entrance. The character of the Conservation Area is largely derived from the group value of these buildings and open spaces as a social, economic and cultural unit. The colliery site has been identified for employment purposes (EM1Rc) following its closure in early 2000. Any future development of this site will need to consider the historic value of any buildings and structures worthy of retention, in accordance with site brief E3 in Appendix 4.

ANCIENT MONUMENTS AND ARCHAEOLOGICAL SITES

POLICY EV11 DEVELOPMENT AFFECTING ANCIENT MONUMENTS OR OTHER SITES OF ARCHAEOLOGICAL INTEREST WILL ONLY BE PERMITTED WHERE:-

In the case of an Ancient Monument:

- a) IT WOULD PRESERVE A SCHEDULED ANCIENT MONUMENT OR OTHER NATIONALLY IMPORTANT MONUMENT AND/OR ITS SETTING,**

In the case of other sites of archaeological interest:

- b) IN-SITU PRESERVATION IS MERITED, IT WOULD NOT INVOLVE SIGNIFICANT ALTERATION OR CAUSE DAMAGE OR WOULD HAVE A MAJOR ADVERSE IMPACT ON ITS SETTING, OR**
- c) IN-SITU PRESERVATION IS NOT POSSIBLE AND THE NEED FOR THE DEVELOPMENT OUTWEIGHS THE IMPORTANCE OF THE REMAINS AND ARRANGEMENTS ARE IN PLACE FOR THE SITE TO BE SURVEYED, EXCAVATED AND RECORDED PRIOR TO DEVELOPMENT.**

Existing Scheduled Ancient Monuments are listed below and shown on the Proposals Map:

Sutton-in-Ashfield

Sa REMAINS OF OLD MANOR HOUSE

Kirkby-in-Ashfield

Ka MARKET CROSS

Kb FISHPONDS 220m EAST OF ST. WILFRED’S CHURCH

Rural Area

Ra CASTLE HILL, ANNESLEY

Rb ALL SAINTS CHURCH, ANNESLEY

Rc FISH PONDS, SOUTH OF DAMSTEAD FARM, ANNESLEY

Rd CASTLE HILL FORTIFIED MANOR

Re MOUND ON HAMILTON HILL, SUTTON-IN-ASHFIELD

Rf WANSLEY HALL MANORIAL SITE

3.70 Archaeological remains are finite and non-renewable resources, vulnerable to damage and destruction. They contain irreplaceable information about our past and have potential for an increase in future knowledge. Care must be taken to ensure that archaeological remains are not needlessly or thoughtlessly destroyed. Policy EV11 corresponds with the provisions of Structure Plan Review policy 3/4 and also reflects the advice of PPG16, which highlight the need for Development Plans to reconcile the conflict between development interests and those of conservation, including archaeology.

3.71 Nine sites within the District are currently scheduled as Ancient Monuments under the Ancient Monuments and Archaeological Areas Act, 1979. These are considered to be of national importance and will be protected from development. Elsewhere within the District there are many sites and areas regarded as being of archaeological interest, including historic landscapes. The County Council maintain and update a County Sites and Monuments Record listing currently known archaeological sites and features of local historical interest.

- 3.72 Early consideration should be given by developers to the question of whether archaeological remains exist on a site and the implications for a proposed development. The County Archaeologist should be contacted for advice on locations where remains are known or thought to exist. Advice can be given on the best means to preserve and enhance remains that have been previously identified. Where sites are of known or potential archaeological significance developers may be required to submit the results of an archaeological evaluation with any planning application. Evaluations of this kind help to define the character and extent of the archaeological remains, and thus indicate the weight which ought to be attached to their preservation. The level of importance of the site can then be assessed against the need for the proposed development. If archaeological remains are discovered during development, developers should contact the Local Authority immediately for advice.
- 3.73 The preservation of archaeological sites in-situ will nearly always be preferred to "preservation by record". There are often opportunities to avoid the disturbance of remains by raising ground levels under a proposed new structure, introducing raft foundations, or by the careful siting of landscaped or open areas. This will secure their long term preservation even though they will remain inaccessible for the time being. Where the physical preservation of archaeological remains in-situ is not possible (EV11 (c)) the Authority will ensure that adequate provision is made for the survey, excavation and recording of remains, where appropriate, through the use of planning conditions or a planning obligation.

LISTED BUILDINGS

POLICY EV12 DEVELOPMENT INVOLVING THE ALTERATION, EXTENSION OR RE-USE OF A LISTED BUILDING WILL ONLY BE PERMITTED WHERE:-

- a) **IT PRESERVES THE CHARACTER OF THE LISTED BUILDING AND ITS SETTING,**
- b) **IT RESPECTS THE SCALE, DESIGN AND MATERIALS OF THE EXISTING BUILDING,**
- c) **REDEVELOPMENT FOLLOWING DEMOLITION IS UNDERTAKEN WITHIN AN AGREED TIMESCALE.**

IN THE CASE OF DEMOLITION OR PARTIAL DEMOLITION IT CAN BE DEMONSTRATED THAT THE BUILDING IS BEYOND ECONOMIC REPAIR, VIABLE ALTERNATIVE USES CANNOT BE FOUND OR REDEVELOPMENT WOULD PRODUCE SUBSTANTIAL PLANNING BENEFITS FOR THE COMMUNITY THAT WOULD OUTWEIGH THE BUILDING'S LOSS.

- 3.74 The District contains 82 buildings or structures which are statutorily listed by the Department of Culture, Media and Sport as being of special architectural or historic interest. A list is contained in Appendix 3. Advice on listed buildings is contained in PPG15 which lays down the principal considerations for applications involving the repair, alteration or demolition of such buildings. The number of listed building applications is very small compared with the number of buildings in the area and their appearance on the list is a recognition of their architectural or historic importance either locally or nationally. It is therefore essential that all such buildings are retained whenever possible and maintained in a satisfactory state of repair.
- 3.75 Where a listed building is to be extended or altered an inappropriate design can have a particularly harmful effect upon its character and appearance and, equally important, its setting in relation to the scale and character of the buildings around it. Proposals for such alterations or extensions must therefore respect the character and scale of the building. Care is required to avoid damage, to ensure retention of specific features of importance and to make the correct use of materials.
- 3.76 The best use for an historic building is normally that for which it was designed. In many cases it must be accepted that the continuation of the original use is not now a practicable proposition and it will often be essential to find appropriate alternative uses to secure the future of the

building. However, any alternative uses should respect the fabric and appearance of the building and require the minimum of internal and external alteration. The Authority will ensure that every possible effort has been made to secure an alternative use for a building before considering any proposals to demolish. Only in the most exceptional circumstances will consent be given for its demolition and, where a listed building falls into disrepair, legal action may be taken against the owner to secure its repair. A Buildings at Risk up-date survey was carried out by Nottinghamshire County Council during the summer of 1999 and identifies any listed buildings in the District that are in a poor state of repair. The survey is based on English Heritage guidelines which were introduced in 1980 to identify listed buildings and scheduled ancient monuments known to be at risk or vulnerable. The Buildings at Risk Register is maintained and updated by the County Council.

SETTING OF LISTED BUILDINGS

POLICY EV13 DEVELOPMENT WILL ONLY BE PERMITTED WHERE THROUGH ITS SITING, SCALE OR DESIGN, IT PRESERVES THE SETTING OF A LISTED BUILDING.

- 3.77 The setting of a Listed Building is often an essential part of its character and appearance and will be protected where development is likely to have a significant adverse affect. Such development may be some distance away from the Listed Building itself but could affect views essential to its appearance and character. Particular consideration will be given to developments which may sever such buildings from their surroundings such as new traffic routes, car parks or other development.

HISTORIC PARKS AND GARDENS

POLICY EV14 DEVELOPMENT WHICH WOULD ADVERSELY AFFECT HISTORIC PARKS AND GARDENS OR THEIR SETTING WILL NOT BE PERMITTED.

Existing Registered Historic Parks and Gardens are listed below and shown on the Proposals Map:

Rural Area

Ra ANNESLEY HALL

Rb HARDWICK HALL GROUNDS (THAT PART WITHIN ASHFIELD)

An existing Non-Registered Historic Park and Garden is listed below and shown on the Proposals Map:-

Sutton-in-Ashfield

Sa SKEGBY HALL

- 3.78 Although historic parks and gardens do not have the same statutory protection as listed buildings, they are nevertheless of much historic interest and amenity value and are worthy of preservation. The Historic Buildings and Ancient Monuments Act, 1953, as amended by the National Heritage Act, 1983, empowers English Heritage to compile a register of gardens and other land which appears to be of special historic interest. The register has no statutory force, but nevertheless indicates the existence of such areas to ensure that development proposals should take account of the need to safeguard these areas generally. In particular, care should be taken to avoid the loss of trees or woodland, and any proposed loss will need to be assessed against policy EV8 which protects all trees worthy of retention. In Ashfield two areas have currently been identified for inclusion within the register, together with one non-registered area at Skegby Hall.

- 3.79 Annesley Hall (EV14Ra) includes the whole of the parkland historically associated with the Hall which is itself a Grade II listed building. The area includes extensive open parkland, woodland, an arboretum and other features such as an ice house, recently reconstructed following improvements to the A608 and an osier bed. The boundary encompasses land now in separate

ownerships including part of the Kodak site and a development commitment (EM1Rb) at the Sherwood Business Park Enterprise Zone.

- 3.80 In addition there is an outstanding commitment in principle for limited residential development affecting part of the arboretum area at Annesley Hall. However with the passage of time the arboretum has matured such that large areas could no longer physically accommodate dwellings. It is now considered that any such future development should be confined to the western section of the arboretum where the effects would be less significant. More recently, Ashfield District Council commissioned a study which involved a careful assessment of the condition of the Listed Buildings and the grounds. The study resulted in a report of recommendations with respect to urgent repairs and preservation works. Parallel with the report, a Development Brief for the site has now been prepared to bring together all of the relevant issues relating to the site.
- 3.81 Hardwick Hall itself lies outside the District boundary but the landscaped gardens and grounds extend into the northern part of Ashfield (EV14). This includes a tree-lined avenue, Lady Spencer's Wood, and Park Spring Woodland.
- 3.82 The grounds of Skegby Hall comprise an historic planned formal garden including tree planting around an open space and the remains of a formal water garden. The gardens were laid out as part of Skegby Hall which has now been restored for residential use. Ashfield District Council has recently acquired a considerable part of the gardens and intend to carry out improvements to this area and provide public access. Whilst the grounds are not included in the Historic Parks and Gardens Register, it is considered that the grounds should be recognised and protected for their local interest.

DERELICT AND CONTAMINATED LAND RECLAMATION

POLICY EV15 PROPOSALS WHICH ASSIST IN THE RECLAMATION OF DERELICT AND CONTAMINATED LAND TO APPROPRIATE USES WILL BE PERMITTED.

- 3.83 PPG1 emphasises that urban regeneration and the re-use of previously developed land, also known as "brownfield sites", are important objectives for creating a more sustainable pattern of development. Furthermore, the reclamation of previously developed land in both urban and rural areas, will also minimise pressure to develop greenfield sites. In this respect the Authority has incorporated this approach as a key part of the plan strategy. In meeting these aims an urban capacity study was undertaken to identify all vacant sites. The details of the exercise are contained in the Technical Paper No. 1 'Urban Capacity Study'. As a result of the study some new sites have been identified in the plan and others, mainly small sites under 0.4 hectares, may come forward for development during the plan period.
- 3.84 The Leasehold Reform, Housing and Urban Development Act, 1993 makes provision for grant assistance for the reclamation of derelict land. Ashfield is a Derelict Land Clearance Area eligible for 100% grant assistance on Local Authority schemes. In this respect both the District and County Councils, with assistance from English Partnership have successfully reclaimed derelict areas in the District mainly related to former colliery or railway land. The District and County Councils will continue to pursue opportunities, through grant assistance where possible, to reclaim derelict sites.
- 3.85 Derelict sites often involve land that has lain undisturbed for many years. In some cases these sites have reverted to semi-natural habitats of nature conservation interest. Where such sites occur within urban areas and are appropriate for development, the need to reclaim that site may result in the loss of a habitat. However, consideration must be given to the best ways of protecting any nature conservation interests. Policy EV6 and paragraph 3.46 refer to such areas and the possibility of creating alternative new habitats.
- 3.86 The principals of the re-use of brownfield sites include those affected by contamination, as advised in PPG23. The Government's policy towards tackling the UK's burden of land

contamination is that the works, if any, required to be undertaken for any contaminated site should deal with any unacceptable risks to health or the environment, taking into account its actual or intended use. Although contamination is subject to controls under pollution control legislation, known, or potential contamination can be a material consideration and should be taken into account when determining planning applications.

- 3.87 Proposals involving the redevelopment of contaminated land should, where appropriate, include detailed information on the nature and extent of contamination and any necessary remedial measures required. Where a contaminated site is to be sub-divided, any necessary remedial measures should be included as part of a comprehensive methodology for the site as a whole. Planning conditions or planning obligations will be used to ensure appropriate remedial measures are carried out. Where it is suspected that a site may be contaminated, conditions may be used to ensure development does not start until site investigations are carried out and all remedial measures shown in the assessment are incorporated in the development. There may be opportunities for improvements to water resources through the redevelopment of contaminated sites.

WATER QUALITY AND FLOOD PROTECTION

POLICY EV16 DEVELOPMENT WILL BE PERMITTED WHERE:-

- a) IT WOULD NOT ADVERSELY AFFECT THE QUALITY OF SURFACE WATERS OR GROUNDWATER,**
- b) IT WOULD NOT INCREASE THE RISK OF FLOODING,**
- c) IT WOULD NOT BE AT RISK FROM FLOODING ITSELF,**
- d) ADEQUATE PROVISION IS MADE FOR ACCESS TO WATERCOURSES FOR FUTURE MAINTENANCE.**

PLANNING CONDITIONS WILL BE IMPOSED OR A PLANNING OBLIGATION WILL BE NEGOTIATED AS APPROPRIATE TO SECURE COMPENSATORY MEASURES TO OFFSET ANY POTENTIAL ADVERSE EFFECTS OF NEW DEVELOPMENT ON THE WATER ENVIRONMENT AND ASSOCIATED LANDS.

- 3.88 The protection of water resources from potentially harmful effects of new development is a key part of ensuring a sustainable environment. The Authority has a role to play in resisting development where it would threaten the quality of water supplies or increase flood risk or be at direct risk from flooding itself. This will be achieved through close consultation with the Environment Agency which has statutory responsibility for managing water resources, including the issuing of abstraction licences and the enforcement of such licences, pollution control, flood defences and the preparation of Local Environment Agency Plans (LEAPs).
- 3.89 The availability of water supply and sewage disposal services will influence the scale, location and timing of development. This is the statutory responsibility of Severn Trent Water who control connection to existing services or provide new infrastructure, and consent to discharge trade effluent, waste or other pollutants to the public sewerage system. Severn Trent Water has identified 'Cordon Sanitaire' around sewage works within which there may be adverse affects from odours or insect infestation on new development. Where a proposed land use or development conflicts with a sewage treatment process this will be considered in accordance with policy ST1(e).
- 3.90 The protection of water resources is essential to ensure that the needs of households, industry and agriculture are met and to sustain, and where possible enhance, the aquatic environment. The Authority can only concern itself, however, with the acceptability of development and land use change over which it has planning control and furthermore cannot control the processes or substances themselves which is the concern of other statutory bodies. Development which disturbs contaminated sites can have a particularly harmful effect on groundwater and watercourses.
- 3.91 Parts of Ashfield are important with respect to groundwater resources, being located on areas

of major aquifers namely the Lower Magnesian Limestone and Triassic Sherwood Sandstone. Groundwater resources are an essential source of water for public supply, industry and agriculture and also help to sustain the baseflows of rivers. Once groundwater is polluted the resource may be lost for many years and, therefore the protection of these resources from potentially polluting development will be strictly enforced.

- 3.92 Ashfield has two licensed public water abstraction sources within its boundaries at Rushley and Normans Hollow. Guidance on the acceptability of development in relation to groundwater quality is contained in the Environment Agency publication, 'Policy and Practice for the Protection of Groundwater 1998'. Source Protection Zone (SPZ) plans are being prepared by the Environment Agency around potable supply abstraction points which will identify those specific areas highly vulnerable to different types of land use activity and which of these it will resist or seek protective measures from. The SPZ's around boreholes located in Ashfield are likely to cover a large section of the undeveloped land to the east of Sutton-in-Ashfield and Kirkby-in-Ashfield. The Environment Agency has published large scale groundwater vulnerability maps covering Ashfield which identifies those areas that may be sensitive to new development.
- 3.93 New development in river floodplains may be at direct risk from flooding or increase the risk of flooding locally and elsewhere by the removal of floodwater storage capacity, by impeding the flow of flood water or by affecting flood defences. The Council will resist development in areas the Environment Agency identify as being at unacceptable risk from flooding unless flood protection or compensatory measures can be agreed. These will be secured by planning conditions or planning obligations and may include new flood defences, restoration of the floodplain or adequate storage measures.
- 3.94 Unless carefully designed and sited, development may lead to an unacceptable increase in the rate and volume of surface water run-off potentially increasing the risk of flooding locally and downstream, often causing damage to the natural river environment. Development can also adversely affect groundwater resources by reducing natural recharge from surface water. Where new development is likely to result in unacceptable increases in surface water flows, planning conditions or a planning obligation will be used, where appropriate, requiring on or off-site compensatory measures to be carried out such as watercourse improvements or surface water balancing. Wherever practical, developers will be encouraged to provide Sustainable Urban Drainage Systems (SUDS) as part of future developments. SUDS offer a wide range of techniques such as the use of infiltration areas or soakaways. SUDS are effective for reducing the impact of surface water discharge and is considered to be significant in the process of delivering sustainable urban development.

TELECOMMUNICATIONS

POLICY EV17 DEVELOPMENT OF TELECOMMUNICATION INSTALLATIONS WILL BE PERMITTED WHERE, SUBJECT TO TECHNICAL CONSIDERATIONS ON SITING:-

- a) **THERE ARE NO SATISFACTORY ALTERNATIVE SITES OR THERE IS NO REASONABLE POSSIBILITY OF SHARING EXISTING FACILITIES,**
- b) **IN THE CASE OF RADIO MASTS, THERE IS NO REASONABLE POSSIBILITY OF ERECTING ANTENNAE ON EXISTING BUILDINGS OR STRUCTURES.**
- c) **THEY ARE SITED AND DESIGNED, INCLUDING ANY LANDSCAPING REQUIREMENTS, SO AS TO MINIMISE ITS VISUAL IMPACT ON THE AMENITY OF THE AREA, WITHOUT INHIBITING OPERATIONAL EFFICIENCY.**

- 3.95 It is recognised that modern telecommunications are an essential and beneficial element of the

economy and that the industry is continuing to develop rapidly. Government policy is to facilitate the growth of telecommunications, including cellular radio and cable television whilst keeping the environmental impact to a minimum. In this respect many telecommunications installations are covered by the General Development Order and are permitted development. Where new equipment and structures require planning permission it is recognised that constraints will be imposed on siting due to technological limitations imposed by the type of network involved and the technology available at the time. For example, some types of radio systems operate from a limited number of large masts covering a very wide area, while other systems, such as cellular radio, operate in "cells" of limited range transmission which may require "line of sight" communication. Equally the development of systems is governed by the growth in subscribers which can impose greater needs for equipment to be located in urban areas or close to trunk road networks. The Government has published specific guidance on this subject in PPG8 to take account of both the industry's needs and environmental considerations.

- 3.96 Ashfield contains the highest land in Nottinghamshire, some in excess of 600 feet, and a number of communication towers already exist in the area, some erected as permitted development. Proposals for new facilities will be considered in relation to the overall network provision to ensure that alternative locations do not exist. Where alternative facilities are already available, the Authority will wish to ensure that there is no possibility of sharing before accepting new structures. In this respect it is acknowledged that the licence conditions imposed on operators require them to investigate sharing of mast facilities or erecting, in co-operation with other operators, a mast for joint use. Operators will be expected to demonstrate that such possibilities have been explored. Where possible, existing buildings and other structures should be considered as possible sites for locating telecommunications equipment before the erection of specialist mast structures.
- 3.97 Care must be taken when siting and designing new structures to minimise their environmental impact on the amenity of the surrounding area and in particular the best and most sensitive environments. Such areas requiring special consideration are included within the policies of the Environment Chapter of this Plan. Consideration should be given to potential effects on the openness of Green Belt areas (EV1) and the character and openness of countryside areas (EV2). Any potential adverse effects should also be considered in other sensitive environments including Mature Landscape Areas (EV4), SSSIs (EV5), SINC's and LNRs (EV6), sites and buildings supporting species protected by law (EV7), Listed Buildings (EV12 and 13) and Historic Parks (EV14) including potential effects on their setting. The appearance of new structures should be sympathetic to the local environment in terms of proposed materials, colour and design. The use of appropriate materials and colouration may allow a structure to blend more easily with its surroundings. The design of the structure including overall shape, and whether the construction in solid or forms an open framework will also be considered. Innovative design solutions will be encouraged. The scope of landscaping and screening to reduce the impact of the development on its surroundings will be an important consideration.

MINERALS LOCAL PLAN

- 3.98 Ashfield lies at the south-eastern extremity of the Yorkshire and East Midlands Coalfield where coal is sufficiently close to the surface for extraction by opencast methods. The responsibility for determining planning applications for mineral extraction rests with the County Council as Minerals Planning Authority. The County Council will consult the relevant District Council on any minerals planning application within their area. The first Nottinghamshire Minerals Local Plan covering all aspects of mineral extraction in the County was adopted in November 1997 and is currently under review.
- 3.99 Minerals can only be worked where they are found, and therefore a satisfactory balance must be sought between the need for the mineral, safeguarding resources and protecting the environment. The Structure Plan Review sets out the County Council's strategic policies on mineral workings in an attempt to reconcile these issues and conflicts. These policies have been carried forward into the adopted Minerals Local Plan to provide a more detailed framework to control and direct mineral exploitation. Ashfield District Council, supports the presumption against opencast coal extraction in Mature Landscape Areas, which is outlined in

policy M12.1 of the Minerals Local Plan. As a statutory consultee on minerals planning applications, the Authority will base its responses on the likely impact of the proposals on areas of open countryside, including Green Belt, or residential amenity.

WASTE LOCAL PLAN

- 3.100 The responsibility for determining planning applications for waste management facilities rests with the County Council as Waste Planning Authority. The County Council will consult the relevant District Council on any waste planning application within their area. The Waste Local Plan was adopted in January 2002.
- 3.101 One of the most important objectives of the Waste Local Plan is to promote a strategy which helps reduce the dependency on disposal as a waste management option. A parallel objective is to ensure a reasonable balance is struck between meeting the demand for new waste management sites against the need to protect and enhance the environment. New waste management sites will be directed away from sensitive areas, such as the Countryside, Green Belt, vulnerable aquifers, residential areas and sites of importance for nature conservation.
- 3.102 Encouraging the recycling of construction waste where there are economic and environmental benefits is a key component of the Governments waste management policies. In particular, the use of secondary aggregates is encouraged in Minerals Planning Guidance Note No. 6 and also in the emerging Regional Planning Guidance for the East Midlands. Construction and demolition waste can be recycled to form secondary aggregates. Crushed bricks and rubble can for example be re-used on building sites for levelling purposes and in some cases graded for use in road and path construction. Using waste in this way conserves mineral resources and consequently reduces the potential for environmental impact from mineral extraction. The emerging Waste Local Plan for Nottinghamshire includes provision for recycling construction and demolition waste. The District Council fully supports this approach in Nottinghamshire and will encourage good practice in accordance with National, Regional and County policy guidance. The latest national guidance for waste is the "Waste Strategy 2000 for England and Wales", which was published in May 2000.

RENEWABLE ENERGY

POLICY EV18 DEVELOPMENT OF RENEWABLE ENERGY SOURCES WILL BE PERMITTED WHERE THERE WOULD BE NO ADVERSE EFFECT INDIVIDUALLY OR CUMULATIVELY ON:

- a) **THE CHARACTER OR APPEARANCE OF THE AREA; OR,**
- b) **AREAS OF NATURAL, CULTURAL, HISTORIC OR ARCHAEOLOGICAL INTEREST, AS DEFINED ON THE PROPOSALS MAP; OR**
- c) **THE AMENITIES OF NEARBY RESIDENTS OR THE OPERATION OF OTHER ESTABLISHED USES IN THE VICINITY DUE TO VISUAL DOMINANCE, NOISE, DISTURBANCE, VIBRATION, SMELL, FUMES, DUST, REFLECTED LIGHT, SHADOW FLICKER OR OTHER FORMS OF POLLUTION.**

IN ASSESSING THE IMPACT OF THE PROPOSED DEVELOPMENT, ACCOUNT WILL BE TAKEN OF THE POSSIBILITY OF INCLUDING MITIGATING MEASURES AND OF THE WIDER ENVIRONMENTAL BENEFITS.

- 3.103 There has been a tendency for energy to be supplied from increasingly large and centralised fossil fuel and nuclear generating sources. The burning of fossil fuels generates high proportions of greenhouse gases which the government has undertaken to reduce by 12.5% below 1990 levels by 2010. Renewable energy sources of power from the sun, wind, water or burning of waste products offer the hope of increasing diversity and security of energy supplies and reducing harmful emissions to the environment. At the same time, energy conservation to

reduce the total demand for energy can also contribute to the protection of the environment.

- 3.104 Government policy encourages the development of renewable energy sources where they have prospects of being both economically competitive and acceptable in terms of impact on the environment. The target is to produce 10% of the UK electricity requirements from renewable energy by 2010 and the Government is consulting on an extension to this target to 20% by 2020. PPG22 requires Local Plans to consider the contribution their area can make to meeting this need, taking into account specific environmental, conservation, social and economic factors. RPG8 sets out regional guidance for renewable energy and includes targets for grid connected electricity that each renewable technology could expect to produce by 2003 and 2010. This assessment is based on information provided in the Regional Assembly's 'Viewpoints on Sustainable Energy in the East Midlands' published in 2001.
- 3.105 Wind power is on the verge of widespread commercial exploitation as a source of electricity generation and, compared with other forms of renewable energy, is relatively easy to provide. In Ashfield, the northern parts of the District contain some of the highest land in Nottinghamshire where wind generated power may be a possibility. However, large parts of these high areas are close to the edges of Huthwaite and Stanton Hill or near the areas of landscape interest in the vicinity of Hardwick Hall. The southern part of the District, outside the Main Urban Areas and Named Settlements, lies in the Green Belt where the visual impact of such uses would render them inappropriate. It is unlikely, therefore, that large wind farms are justifiable in the District and any use of wind turbines is likely only to be for local needs. This and other environmental policies in the plan, will be used to consider such applications.
- 3.106 There is considerable local interest in the prospect of cultivating energy crops such as coppiced willow or waste straw for combustion. A further "bio-mass" resource is available from wood thinnings from conventional forestry and, in particular, the Greenwood Community Forest may be able to make a contribution towards this, near the end of the plan period. Care must be taken when considering the location and acceptability of any combustion plant for such use to minimise their environmental impact on the amenity of the surrounding area and in this respect other environmental and other site consideration policies in the Structure Plan and Local Plan as appropriate.
- 3.107 Disposal sites containing organic waste, can generate large quantities of landfill gas, which mainly comprise the flammable gas methane. Landfill gas can be collected, burnt and the heat used to generate electricity. An energy recovery scheme is currently operating at the Sutton landfill site which represents a means of deriving residual value from landfilled waste, and at the same time minimises atmospheric pollution, as methane is one of the most potent 'greenhouse' gases.

CHAPTER 4: EMPLOYMENT

INTRODUCTION

- 4.1 The economy of Ashfield has been traditionally concentrated on coal mining and manufacturing, particularly clothing, textiles and engineering. Despite the decline of the coal mining industry the District maintains a strong manufacturing base. The 1996 Annual Employment Survey indicated that of the 39,000 people working in Ashfield, 16,500 (42%) were employed in manufacturing.
- 4.2 The Council has given a high priority to the development of economic opportunity and regeneration through the annual Economic Development Statement and the adopted Ashfield Local Plan. These documents aim to promote development of the economy of Ashfield by encouraging creation of new, and support for existing, industrial and commercial activity to develop job opportunities.
- 4.3 The Authority will continue to promote economic development through the allocation of land suitable for a range of employment uses in accordance with the policies and guidelines established in the Nottinghamshire Structure Plan Review. The proposed employment land allocations in this plan are generally concentrated in the Main Urban Areas of Hucknall, Kirkby-in-Ashfield and Sutton-in-Ashfield. These are well located to take advantage of the strategic transport network with excellent road links to the M1 motorway and rail links on the Robin Hood Line to Nottingham, Mansfield and Worksop. This will be further improved by the NET high speed tram link between Hucknall and Nottingham and the proposed Mansfield-Ashfield Regeneration Route which will improve accessibility to the A1 and M1. These links will assist in attracting business to the allocated employment sites and also improve access for Ashfield residents to job opportunities both within and outside of the District.
- 4.4 The Authority has been successful in encouraging economic regeneration and inward investment by attracting external financial assistance from many sources including the European Union, English Partnerships, Single Regeneration Budget and the Rural Development Commission. In particular an Enterprise Zone has been designated at the Sherwood Business Park off junction 27 of the M1 creating a prestige employment site offering fully serviced land and a package of Enterprise Zone benefits. This continues to attract inward investors offering very significant job opportunities. Financial assistance has also enabled the Council to reclaim land for employment uses, provide serviced industrial sites, construct workshop units to let and assist local businesses.

CENTRAL GOVERNMENT ADVICE

- 4.5 PPG1 'General Policy and Principles' indicates that authorities should take account of economic considerations such as revitalising and broadening the local economy and stimulating employment opportunities. Locational needs of business should be taken into account and this should be compatible with environmental objectives and sustainable development practices. Mixed use developments are also encouraged particularly in highly accessible areas such as town centres.
- 4.6 PPG4 'Industrial and Commercial Development and Small Firms' re-emphasises PPG1 and provides further detailed guidance on a range of issues relating to industrial and commercial development and small firms both in urban and rural areas. PPG7 'The Countryside, Environmental Quality and Economic and Social Development' provides guidance on encouraging rural business and the diversification of the rural economy.
- 4.7 PPG13 'Transport' indicates that employment sites should preferably be concentrated to urban areas well served, or with potential to be served by public transport and easily reached from local housing by public transport, cycling and walking. PPG24 'Planning and Noise' refers to considerations to be taken into account in respect of noise sensitive development and for those activities that will generate noise. This is particularly relevant to the Rolls Royce plant in Hucknall.

STRUCTURE PLAN REVIEW

- 4.8 Nottinghamshire Structure Plan Review policy 2/1 indicates, that as a guideline, provision should be made for some 305 hectares of land for employment purposes in the Ashfield area during the period 1991-2011, of which 70 hectares is to be located in the Hucknall area (policy 13/2) and 235 hectares in the remainder of the District (policy 13/6). Structure Plan policies 2/2 and 2/3 indicate the need to provide a range of sites for different employment purposes and to ensure employment land availability throughout the Plan period.
- 4.9 Structure Plan policy 2/4 states that most employment development should be located within and adjoining urban areas with a limited amount of development being permitted in villages identified in Local Plans. Elsewhere, proposals for development will only be permitted where they accord with other policies in the Structure Plan relating in general to economic development and environmental and amenity considerations.
- 4.10 Structure Plan policies 2/6, 13/3 and 13/7 identify locations where provision will be made for prestige employment development requiring a high quality setting. In Ashfield the Enterprise Zone at Sherwood Business Park is identified. Locations along the proposed Mansfield-Ashfield Regeneration Route are also identified as suitable.
- 4.11 Structure Plan policy 2/7 considers exceptional developments which may create many jobs but which cannot be accommodated on existing employment land allocations. Such developments, by their nature, usually involve major one-off opportunities which are impossible to make provision for in a local plan without further details. Proposals of this nature are likely to require an environmental assessment. Structure Plan Review Policy 2/7 does not apply within the Green Belt. Exceptional developments will be considered against the following criteria from Structure Plan Review policy 2/7 and other relevant policies.
- a) There would be substantial proven employment benefits,
 - b) The proposal cannot reasonably be implemented on land provided for employment purposes in the Local Plan, and
 - c) Environment, traffic and other effects would be acceptable in accordance with policy 3/20 of the Structure Plan.

EMPLOYMENT OBJECTIVES

- 4.12
- a) To identify land for employment development in appropriate locations to meet the Structure Plan Review guideline requirement to 2011.
 - b) To encourage economic development and regeneration of the District and diversify the local economy by ensuring the provision of an adequate range and choice of employment sites in terms of size, quality and location.
 - c) To ensure that appropriate employment development is concentrated in the Main Urban Areas.
 - d) To allow for appropriate limited employment development in the Named Settlements.
 - e) To allow for appropriate employment development in the Green Belt and Countryside which helps to diversify the rural economy.
 - f) To ensure that employment development is acceptable in terms of environmental and amenity considerations.

EMPLOYMENT LAND REQUIREMENTS AND PROVISION

- 4.13 The Local Plan is required by the Structure Plan Review to consider the total guideline requirements for employment land for the South Notts. and West Notts. Sub-Areas over the plan period to 2011. Table 4.1 below summarises the current position.

Table 4.1 - Employment Land Requirements and Provision, 1991-2011 in Hectares (Ha) (as at Dec. 2000)			
	Hucknall (South Notts.Sub-Area)	Rest of Ashfield West Notts.Sub-Area)	District Total
1. Structure Plan guideline requirement, 1991-2011	70	235	305
2. Land developed, 1991-Dec 2000	18.4	86.8	105.2
3. New land required, Dec 2000 to 2011 (1 minus 2 above)	51.6	148.2	199.8
4. Land with planning permission at December 2000, in policy EM1	6	48.8	54.8
5. Additional land identified in Policy EM1	38.9	100.6	139.5
6. Total land identified in Policy EM1	44.9	149.4	194.3
7. Balance of requirement/provision 1991-2011 (6 minus 3 above)	-6.7	1.2	-5.5

- 4.14 Table 4.1 above indicates the guideline requirements for employment land in Hucknall (South Notts) and the rest of the District (West Notts) as identified in the Structure Plan Review for the period 1991-2011. The Structure Plan makes it clear that this provision identified for employment land is a guideline only rather than a precise target. Employment land developed between April 1991 and 31st December 2000 is shown and, after deducting this from the Structure Plan requirement, the balance of new employment land required in the Local Plan is given. Table 4.1 then shows the total amount of employment land with planning permission at 31st December 2000 and other land the Council intends to allocate for employment uses, both of which are listed in policy EM1.
- 4.15 Policy EM1 below identifies the total gross hectareage for each employment site and indicates where all or part of a site had planning permission at 31st December 2000. Some of the land identified in policy EM1 that does not have planning permission was allocated for employment purposes in the adopted Ashfield Local Plan and as such can be considered as an existing commitment where the principle of employment uses has been established. Employment land carried forward as a commitment is referred to in the supporting text for individual sites in paragraphs 4.24 to 4.41.
- 4.16 Table 4.1 compares the total amount of land identified for employment uses in policy EM1 against the requirement for new employment land from 2000 to 2011. Policy EM1 identifies a total of 44.9 hectares of land for employment uses in Hucknall (South Notts. Sub-Area) comprising 6 hectares of land with planning permission and 38.9 hectares of other land. This represents a shortfall of 6.7 hectares below the guideline of 51.6 hectares of land required between 2000 and 2011.
- 4.17 Policy EM1 identifies a total of 149.4 hectares of land for employment uses in the rest of the District (West Notts.) comprising 48.8 hectares of land with planning permission and 100.6 hectares of other land. This represents a small overallocation of 1.2 hectares against the guideline of 148.2 hectares of land required between 2000 and 2011 shown in table 4.1.

- 4.18 In terms of the District as a whole, Table 4.1, indicates that there are 194.3 hectares of employment land allocated in policy EM1 leaving a shortfall of 5.5 hectares below the guideline of 199.8 hectares of new land required between 2000 of 2011. Consequently, for the District as a whole, sufficient land is identified to satisfy the guideline requirements of the Structure Plan over the plan period. Furthermore an adequate range and choice of sites in terms of size, quality and location have been identified to satisfy the diverse needs of business and to further encourage regeneration.
- 4.19 In addition to the Structure Plan Review guidelines for total employment land provision over the plan period, there is also a requirement in Structure Plan policy 2/3 that an adequate supply of readily developable employment land (without major constraint) is available throughout the plan period. The scale, type and range of sites made available in this plan will ensure this requirement is likely to be achieved. This position will however be monitored through the annual employment land availability studies and any difficulties addressed in future plan reviews.

EMPLOYMENT LAND ALLOCATIONS

POLICY EM1 EMPLOYMENT DEVELOPMENT, INCLUDING ROAD-RELATED DEVELOPMENT WHERE INDICATED, WILL BE PERMITTED ON THE SITES LISTED BELOW AS SHOWN ON THE PROPOSALS MAP:-

Hucknall		Hectares (Gross)
Ha	ROLLS ROYCE, WATNALL ROAD	13.0
Hb	WATNALL ROAD	0.8
Hc	FORMER HUCKNALL NO.1 COLLIERY/WATNALL ROAD*	3.0
Hd	NORTH A611/WATNALL ROAD	0.6
He	BUTLERS HILL	3.2
Hf	BAKER BROOK INDUSTRIAL ESTATE*	3.5
Hg	WIGWAM LANE CENTRAL	1.0
Hh	AMBER BUSINESS PARK (former Hucknall Colliery)	1.1
Hi	FORMER LINBY COLLIERY	0.9
Hj	ANNESLEY ROAD/A611	2.3
Hk	DANIELS WAY/WATNALL ROAD*	1.4
 Kirkby-in-Ashfield		
Kb	LOWMOOR ROAD INDUSTRIAL ESTATE	2.6
Kc	WELSH CROFT CLOSE NORTH/PORTLAND IND. EST.	4.1
Kd	WOLSEY DRIVE NORTH*	0.8
Ke	KINGS MILL ROAD EAST/ODDICROFT LANE#	6.3
Kf	ODDICROFT LANE WEST*	2.6
Kg	ODDICROFT LANE EAST	3.1
 Sutton-in-Ashfield		
Sa	PINXTON LANE +	28.0
Sb	WEST OF FULWOOD*	21.2
Sc	OFF FULWOOD RISE/A38/FULWOOD IND. EST.	1.7
Sd	WEST OF ROOKERY LANE/FULWOOD IND. EST.	1.0
Se	COMMON ROAD FARM/FULWOOD IND. EST.*	2.7
Sf	FULWOOD ROAD NORTH/FULWOOD IND. EST.	1.6
Si	NUNN BROOK ROAD EAST/COUNTY IND. EST.	3.0
Sj	MIDLAND ROAD/STATION ROAD*	0.6
Sk	SHEEPWASH LANE/COXMOOR ROAD#	3.3
Sl	NORTH OF HAMILTON ROAD	3.7

Sm	COXMOOR ROAD/KINGS MILL	1.2
Sn	BRIERLEY INDUSTRIAL PARK*	4.4

Named Settlement

Na	LAND AT BESTWOOD ROAD*	0.5
-----------	-------------------------------	------------

Rural Area

Ra	BLenheim LANE INDUSTRIAL ESTATE +	13.6
Rb	SHERWOOD BUSINESS PARK*	18.5
Rc	ANNESLEY COLLIERY	9.0
Rd	BENTINCK COLLIERY	6.5
Re	SOUTH WEST OAKHAM BUSINESS PARK +	23.5

* All or part of site with planning permission at 31st December 2000.

Site, or part of site, suitable for road-related development.

+ Site area shown is net following deduction of proposed structural landscaping

DETAILED SITE REQUIREMENTS IN THE SUPPORTING TEXT AND SITE BRIEFS IN APPENDIX 4 WILL BE NEGOTIATED AND SECURED, AS APPROPRIATE, BY PLANNING CONDITIONS OR PLANNING OBLIGATIONS.

EMPLOYMENT SITES WITH PLANNING PERMISSION

- 4.20 Employment sites with planning permission on all or part of the allocation are marked with an asterisk in policy EM1 above. Existing planning permissions represent a significant element of the employment land provision shown in table 4.1. To maintain an adequate employment land supply, sites with planning permission for employment uses will generally be considered to remain suitable for that purpose throughout the Plan period, should those permissions lapse. This will also include new permissions which subsequently lapse within the Plan period.

SHERWOOD BUSINESS PARK

- 4.21 The Sherwood Business Park site, shown as Policy EM1Rb, was identified as the location of a Prestige Business Park in Structure Plan Policy 13/7. The site was designated as an Enterprise Zone (EZ) on 21st November, 1995 and will have this status for ten years. The Council has adopted a Formal Enterprise Zone Scheme following the necessary consultation exercise. This establishes special planning controls which apply only to the EZ. Whilst normal planning controls in this Local Plan would not apply to the EZ, the Authority will ensure through the application of the adopted EZ Scheme that adequate safeguards are applied to the type of user and to protection of the environment within and around the Site. Development of this high quality business park has progressed quickly, largely as a result of the strategic significance of the site lying close to junction 27 of the M1, the attractive environment and the package of incentives offered to inward investors. Some 18.5 hectares of the total 56.5 hectares in the EZ were undeveloped at 31st December 2000. This included provision for a hotel and limited ancillary retail uses as identified in the EZ Scheme. If the site is not fully developed before 2005, the EZ Scheme will cease to apply and all planning applications will be determined in the context of policies in the adopted Local Plan Review for Ashfield.

EMPLOYMENT SITES WITHOUT PLANNING PERMISSION

- 4.22 In addition to the sites identified in Policy EM1 with planning permission a number of sites have been allocated for employment uses which do not have a planning permission on all or part of the site allocation. Many of these sites have however been previously allocated in the adopted Ashfield Local Plan (1995) and can be considered as existing commitments. In identifying sites for employment use, account has been taken of their physical characteristics, development constraints, service provision and accessibility. Where appropriate, and in particular on large

sites, developments should be integrated with existing footpaths, cycleways and public transport provision. All proposals for employment development with floorspace exceeding levels indicated will be required to contribute to transport improvements in accordance with policy TR6. Site briefs showing detailed requirements for the larger sites allocated without planning permission are included in Appendix 4.

- 4.23 The sites without planning permission generally fall within the Main Urban Areas of Hucknall, Kirkby-in-Ashfield and Sutton-in-Ashfield. In addition, site EM1Ra at Blenheim Lane Industrial Estate adjoins an existing industrial estate in the Nottingham City Urban Area and site EM1 Re adjoins an industrial estate in the Mansfield Urban area. These comprise logical extensions of existing industrial areas serving the South Notts. and West Notts. Sub Areas respectively. The colliery sites at Annesley (EM1Rc) and Bentinck (EM1Rd) lie in close proximity to Kirkby and would involve the reuse of existing industrial sites for employment purposes. Where possible derelict sites such as collieries, have been allocated to minimise the loss of greenfield sites. Matters concerning road related development, appropriate uses and hazardous and pollutant industries are considered in paragraphs 4.45 to 4.49. Each of the sites without planning permission are discussed in more detail below and in the site briefs in Appendix 4.

SUMMARY OF EMPLOYMENT LAND ALLOCATIONS

Hucknall

- 4.24 The two employment sites at Rolls Royce, Watnall Road (EM1Ha) form a logical extension of the existing complex which could create significant employment opportunities in the District. The employment allocation comprises an area of land sufficient to accommodate likely expansion of the Rolls Royce plant over the plan period, although additional development on adjacent land also within the Main Urban Area would also be acceptable in principle subject to other plan policies. Paragraphs 4.50 and 4.51 refer to considerations relating to noise generated at the Rolls Royce engine testing facilities and Policy EM2 refers to the consideration of proposals for open air testing facilities adjacent to the Rolls Royce complex. A full ecological survey will be required as part of any development proposal to identify any nature conservation interest on the sites. If any areas within the sites are confirmed as worthy of status as Sites of Importance for Nature Conservation (SINC's) the provisions of Policy EV6 would apply.
- 4.25 Site EM1Hb at Watnall Road is located adjacent to the former Hucknall No.1 Colliery (EM1Hc) which has recently been reclaimed for industrial use, and existing industrial areas off Daniels Way. Allocation of this land will assist in the comprehensive development of this wider industrial area. This site was allocated in the adopted Ashfield Local Plan (1995).
- 4.26 Site EM1Hd North A611/Watnall Road lies adjacent to the Watnall Road junction with the A611 Hucknall By-Pass. This site was allocated in the adopted Ashfield Local Plan.
- 4.27 Site EM1He at Butlers Hill comprising abandoned allotment land would form a logical extension to the Baker Brook Industrial Estate. This site adjoins the existing urban area on its north and west boundaries and is contained to the south east by a substantial tree lined railway embankment. As such development of this site would adequately maintain the openness and purposes of the Green Belt. Loss of trees and hedgerows should be minimised particularly on the external boundaries of this site. Provision should also be made to ensure continued safe usage of the Bestwood Footpath. Land to the east of the allocated area has been subject to landfilling and further investigations will be required to assess the extent of this area and any remedial measures required as part of any development proposal.
- 4.28 The employment site at Wigwam Lane Central (EM1Hg) was allocated in the adopted Ashfield Local Plan (1995) and forms a logical extension to existing industrial areas off Wigwam Lane.
- 4.29 The Amber Business Park (former Hucknall Colliery) site (EM1Hh) forms part of a proposed mixed-use development of the former Hucknall Colliery site and is well located to take advantage of the public transport links offered by the Robin Hood Line and proposed NET tram system. As the site lies within the defined District Centre of Hucknall, in addition to employment

uses, the site may also be considered appropriate for non-food retail uses, leisure uses such as cinemas and bowling alleys, and other commercial uses including A2 office uses. The site would be accessed off a central spine road serving the mixed use scheme. The site is likely to be contaminated and a comprehensive land reclamation scheme involving other land comprising part of the former colliery will be required. This site was allocated in the adopted Ashfield Local Plan for employment and retail uses.

4.30 The former Linby Colliery site (EM1Hi) has been reclaimed and is fully serviced. Only a small part of the original site now remains undeveloped. This site was allocated in the adopted Ashfield Local Plan (1995).

4.31 The Annesley Road/A611 site (EM1Hj), lying adjacent to the International Textiles Centre and a junction of the Hucknall By-Pass, could provide employment land for uses linked to the Textiles Centre. The site will be accessed solely from the roundabout at the junction of Annesley Road and Wighay Road. Proposals should provide landscaping to the western and southern site boundaries to screen the site and assist in the protection of a green corridor along the Hucknall By-Pass. This site was allocated in the adopted Ashfield Local Plan (1995).

Kirkby-in-Ashfield.

4.32 Site EM1Kb at Lowmoor Road Industrial Estate remains as an undeveloped part of the Industrial Estate, previously with permission for industrial use, now lapsed, and which was allocated in the adopted Ashfield Local Plan (1995). Proposals should include adequate boundary treatment and landscaping to the south and west of the site which adjoins residential areas.

4.33 Land at Welshcroft Close North (EM1Kc) comprises part of the Portland Industrial Estate where a previous outline planning permission has lapsed. Together with the allocation at Wolsey Drive North (EM1Kd) these sites formed part of the original Summit Colliery and as such would require land reclamation prior to development taking place. Both sites were allocated in the adopted Ashfield Local Plan (1995).

4.34 Three sites adjacent to the Oddicroft Lane link road (EM1Ke-Kg), allocated in the adopted Ashfield Local Plan, have the benefit of excellent access to the A38, M1 and Sutton Parkway railway station. In particular the site at Kings Mill Road East/Oddicroft Lane (EM1Ke) occupies a prominent junction location and part of the site fronting the Oddicroft Lane/A38 corner is suitable for road-related development in addition to employment purposes. There should be no access directly from the A38 to this site. Development proposals for these three sites should aim to link to adjacent cycleways and footpaths. Sites EM1Ke and EM1Kg will require off-site highway works to ensure their satisfactory development. Each of the sites at Oddicroft Lane occupies a prominent position between Sutton-in-Ashfield and Kirkby-in-Ashfield and care will need to be given to both the building design and landscaping elements of any development proposals. Landscaping proposals for EM1Ke should reflect the need to maintain a green corridor along the A38. Consideration should be given to landscaping at the southern end of EM1Kg to avoid impinging on the open break to the south of the site. Developers should attempt, as far as is practicable, to retain and protect existing ecological features within these allocations and in particular hedgerows.

Sutton-in-Ashfield

4.35 Land at Pinxton Lane (EM1Sa) is well located to take advantage of fast road links to the M1 and is of a size that will offer significant opportunities for large scale employers and inward investors particularly as the Sherwood Business Park nears completion. The site is suitable for development as a prestige employment site in accordance with Structure Plan Review Policy 2/6. Detailed considerations relating to this site are shown in site brief E1 in Appendix 4.

4.36 Land West of Fulwood (EM1Sb) was included in the adopted Ashfield Local Plan (1995) and has the benefit of either a full or outline planning permission for industrial development. Land to the north of Nunn Brook was reclaimed by the County Council and is currently being developed with access off Common Road. Land to the south of Nunn Brook is subject to landfilling and subsequent restoration for employment purposes with access off Export Drive. Phase 1 of this

- site is currently being marketed for development.
- 4.37 Three sites identified on land off Fulwood Rise A38 (EM1Sc), West of Rookery Lane (EM1Sd) and Fulwood Road North (EM1Sf) form part of the Fulwood Industrial Estate and would take their access from internal estate roads. The two sites fronting the A38 are in a prominent location and a high standard of design and landscaping will be required. The site west of Rookery Lane is also close to residential properties which should be taken into account in the design and landscaping of the site. Sites EM1Sd and EM1Sf were allocated in the adopted Ashfield Local Plan (1995).
- 4.38 Land at Nunn Brook Road East (EM1Si), allocated in the adopted Ashfield Local Plan (1995) and with a previous outline planning permission (now lapsed) forms part of the County Industrial Estate and is a logical rounding off of the estate to Blackwell Road to the north.
- 4.39 The eastern end of the site at Sheepwash Lane/Coxmoor Road (EM1Sk) was allocated in the Ashfield Local Plan (1995) some of which currently has an outline planning permission. Part of this site fronting Coxmoor Road is suitable for road related uses. The larger site now proposed includes a derelict former private open space. Access to this site allocation should be taken from Coxmoor Road. Comprehensive development of the whole site provides an opportunity to relieve a longstanding problem of heavy vehicles using Lucknow Drive to access the Albert Martin hosiery factory. This could be overcome by providing access to the hosiery site from Coxmoor Road through this site allocation and reorganising parking and access arrangements within the hosiery factory area. Development of the private open space is exceptional on the basis that the access difficulties to the Albert Martin factory would need to be resolved in any scheme. In addition a commuted sum payment for alternative or improved open space provision elsewhere should be made to offset the loss of open space on this site. This will be negotiated by the District Council as part of any planning permission. Landscaping and design of any proposed employment development would need to consider the proximity of the site to the A38 and the need to protect a green corridor along this road.
- 4.40 Site EM1SI on land North of Hamilton Road forms a logical extension to the existing Industrial Estate off Newark Road. Vehicular access to this site should be from Hamilton Road where off site works may be required to facilitate a satisfactory means of access. Cycle and pedestrian routes should connect with Coxmoor Road. Trees and hedgerows on the external boundaries of the site should, where possible, be protected and supplementary structural tree planting will be required on the northern and eastern boundaries to screen development from the open break area between Sutton-in-Ashfield and Mansfield. Further investigations will be required to establish the presence of any landfill on this site and the need for any remedial measures.
- 4.41 Brierley Industrial Park (EM1Sn) has been reclaimed by Ashfield District Council for employment uses. Phase 1 of the site is fully serviced and only one plot remains to be developed. Servicing on phase 2 of the site has commenced and plots on this phase are currently being marketed. The reclamation scheme includes substantial tree planting to screen the site which is adjacent to Brierley Forest Park.

Rural Area

- 4.42 Site EM1Ra at Blenheim Lane Industrial Estate comprises a limited expansion of this successful employment area contained by physical boundaries which prevent further expansion. The containment of this site and the limits to its future expansion will ensure that the purposes of the Green Belt as they apply to this area between Nottingham and Hucknall are adequately maintained. The site will benefit from existing infrastructure and services provided on the adjacent industrial area. Detailed considerations relating to this site are shown in site brief E2 in Appendix E4.
- 4.43 Sites EM1Rc at Annesley Colliery and EM1Rd at Bentinck Colliery provide an opportunity to reuse these developed sites after closure of the colliery complex. The allocation of land at Annesley Colliery is generally based on the approach adopted towards 'Major Developed Sites in the Green Belt' in PPG2, Annex C, but recognising the proposed future employment use of the site, the allocation has subsequently been removed from the Green Belt.' The site is contained within logical and defensible boundaries to minimise effects on the openness and purposes of the surrounding Green Belt. Detailed considerations relating to these sites are

- shown in site briefs E3 and E4 in Appendix 4.
- 4.44 Site EM1Re on land to the south west of Oakham Business Park will provide an area of expansion to the adjacent business park and will benefit from the existing infrastructure. This site will be contained to the south by the proposed Mansfield-Ashfield Regeneration Route. The site is suitable for development as a prestige employment site in accordance with Structure Plan Review Policy 2/6. Detailed considerations relating to this site are shown in site brief E5 in Appendix 4.

ROAD-RELATED DEVELOPMENT

- 4.45 Consideration has been given to the provision of sites for road-related development such as petrol filling stations, motels, travellers' restaurant facilities and public houses. Two of the sites shown in policy EM1 and the Special Development Site at Kingsmill Road East (Policy SH10) are considered wholly or partially appropriate for such purposes, because of their proximity to key road junctions. In the context of this policy, road-related uses specifically exclude retail development which is more appropriately located within existing District Centres. The listed sites all occupy prominent locations and the Authority will require high standards of site design and landscape treatment in accordance with policy EM6.

APPROPRIATE USES AND HAZARDOUS AND POLLUTANT INDUSTRIES

- 4.46 The sites listed in policy EM1, which do not benefit from a planning permission, are all considered to be capable of accommodating development falling into either class B1 and/or B8 of the Town and Country Planning (Use Classes) Order, 1987. Development falling within Class B2 may be acceptable on the sites where it can be demonstrated that such proposals would not have a detrimental effect on nearby existing or proposed uses, in particular residential development.
- 4.47 The impact of some employment processes for example hazardous and pollutant industries, is difficult to assess without full knowledge of a specific proposal. It is therefore not considered appropriate to identify specific sites for such purposes without more information. In considering proposals for such development, the Authority will place much importance on the impact of a proposal on adjoining land uses and the local environment. Such uses will not normally be acceptable on employment sites abutting existing or proposed residential areas. Site consideration policy EM6 will specifically apply to any such proposals.
- 4.48 Certain sites and pipelines are designated as notifiable installations by virtue of the quantities of hazardous substance stored or used. The siting of such installations will be subject to planning controls aimed at keeping these separated from housing and other land uses which might be incompatible from the safety viewpoint. To this end, the Planning Authority will seek the advice of the Health and Safety Executive (HSE) on the risks that the notified installation might pose to the surrounding population.
- 4.49 The area covered by this plan already contains a number of installations handling notifiable substances, including high pressure natural gas transmission pipelines. Whilst they are subject to stringent controls under existing Health and Safety legislation, it is considered prudent to control other development permitted in the vicinity of these installations. For this reason the Planning Authority has been advised by the HSE of consultation distances for each of these installations. In determining whether or not to grant planning permission for a proposed development on land within these consultation distances the Planning Authority will take account of the advice it receives from the HSE about risks to the proposed development from the notifiable installation.

DEVELOPMENT IN THE VICINITY OF ROLLS ROYCE, HUCKNALL

- 4.50 One of the largest employers within the District is Rolls Royce which occupies land and premises to the south of Hucknall, where the company operates important manufacturing and aero-engine development and testing operations. Part of this latter process involves monitoring of aero-engines at the open-air test beds located within the site. These unique test facilities are an essential element of the continued prosperity of the company and Ashfield District Council considers it important that Rolls Royce should continue to operate at Hucknall. The nature of

- 4.51 the testing operations however, is such that considerable noise is generated at certain times. PPG24 'Planning and Noise' provides advice on noise-sensitive development near existing industrial premises which are likely to generate noise. In addition to employment land allocated within the Rolls Royce operational area, some of the sites listed in policy EM1 lie close to the Rolls Royce site. In considering development on such sites in proximity of the Rolls Royce operational area, special regard will be paid to standards of noise insulation and attenuation and to methods of building construction, layout, orientation and landscaping in order to ensure that the effects of any noise emissions from the open-air test beds are minimised. Equally the possible effects of any proposed uses on the operations of Rolls Royce will need to be considered. In this respect policy ST1(e) is intended to prevent any development which would conflict with an adjacent or nearby land use. However, circumstances could arise where an acceptable use involves an activity which is sufficiently sensitive to be adversely affected by the activities of Rolls Royce. This could result in an attempt to inhibit activities which are essential to Rolls Royce's continued operations in Hucknall. In such circumstances the Council will wish to be satisfied that developers are made aware of the nature of Rolls Royce's activities to avoid the possibility of either operation being constrained in the future.

OPEN AIR TESTING ZONE AT ROLLS ROYCE

POLICY EM2 IN THE OPEN AIR TESTING ZONE AT ROLLS ROYCE, HUCKNALL, AS SHOWN ON THE PROPOSALS MAP, ONLY TESTING FACILITIES AND ASSOCIATED BUILDINGS AND STRUCTURES SPECIFICALLY REQUIRING AN OPEN AIR LOCATION WILL BE PERMITTED WHERE THEY CANNOT BE DEVELOPED IN THE MAIN URBAN AREA FOR TECHNICAL OR ENVIRONMENTAL REASONS.

- 4.52 The Main Urban Area boundary to the south of Rolls Royce in Hucknall follows the northern edge of the former runway. This is considered to be a logical boundary in order to prevent encroachment of normal built development into the important open area and Green Belt between Hucknall and Nottingham. Development proposals within the Main Urban Area would be permitted, in principle, subject to consideration of other relevant policies in the Plan. A special zone has also been identified on the Proposals Map between the Main Urban Area boundary and the Green Belt boundary to the south within which only special open air testing facilities and associated buildings would be considered in accordance with the policy EM2. Whilst it is intended that this zone should remain largely free from development, the Authority recognises the importance of Rolls Royce to the local economy and as such will consider future proposals for special facilities to carry out open air testing where these cannot for environmental or technical reasons be carried out on land or in buildings within the Main Urban Area. This general approach accords with the views taken by the Planning Inspector who considered these matters at the Public Local Inquiry into the Nottinghamshire Green Belt in 1983. All proposals for new open air testing facilities at Rolls Royce will be considered against all relevant policies in the Local Plan with particular regard given to any potential environmental effects that might arise through noise or other amenity considerations.

OTHER EMPLOYMENT DEVELOPMENT IN THE MAIN URBAN AREAS AND NAMED SETTLEMENTS

POLICY EM3 IN THE MAIN URBAN AREAS AND NAMED SETTLEMENTS, EMPLOYMENT DEVELOPMENT ON LAND NOT ALLOCATED OR SAFEGUARDED FOR OTHER PURPOSES WILL BE PERMITTED

- 4.53 Strategic policies ST2 and ST3 concentrate new development in the Main Urban Areas and allow limited development in the Named Settlements. Policy EM3 allows, subject to other policy constraints in the Local Plan, as yet unidentified sites to be developed for employment purposes within the Main Urban Areas and Named Settlements including land required for the expansion of existing firms.

EMPLOYMENT DEVELOPMENT IN RURAL AREAS

- 4.54 Policies in this plan will give favourable consideration to proposals to diversify the economy in

the rural parts of the District. Limited development is permitted within the Named Settlements of Jacksdale, Selston and Underwood, Brinsley, Bestwood and New Annesley (ST3) and small scale and infill development in other specified villages in the Green Belt (EV1) and Countryside (EV2). Outside of these areas in the Green Belt and Countryside, opportunities for rural diversification exist through the conversion and extension of existing buildings where appropriate as indicated by policy EV3. Whilst the Council encourages local opportunities for employment diversification in rural areas, in practical terms, many existing and proposed employment opportunities either within this district or adjoining districts are generally easily accessible by private or public transport to people living in the rural areas of the District.

PROTECTION OF EMPLOYMENT LAND ALLOCATIONS

POLICY EM4 PROPOSALS FOR ALTERNATIVE USES OF ALLOCATED EMPLOYMENT SITES WILL NOT BE PERMITTED

- 4.55 Using the Structure Plan employment land provision guidelines shown in table 4.1 of this plan, employment land has been allocated in policy EM1 to provide a sufficient range and choice of sites in terms of size, quality and location to meet the needs of the District over the plan period to 2011. Loss of these allocated employment sites would undermine the objectives of encouraging economic development and regeneration of the District and diversification of the local economy. Some of the employment sites may not be developable until later in the plan period due to technical or land ownership constraints and consequently it is important to maintain an adequate supply of readily developable land without major constraint throughout the plan period in accordance with policy 2/3 of the Structure Plan Review. Therefore, with the exception of the potential road related uses on identified employment sites, the hotel and retail uses specified at Sherwood Business Park (EM1Rc) and leisure, non-food retail and other commercial use specified at the Amber Business Park (EM1Hh), other uses of these employment sites will not be permitted.

PROTECTION OF EXISTING EMPLOYMENT SITES AND BUILDINGS

POLICY EM5 PROPOSALS WHICH WOULD CAUSE THE LOSS OF EXISTING EMPLOYMENT SITES OR BUILDINGS WILL ONLY BE PERMITTED WHERE:-

- a) **RETENTION OF EMPLOYMENT USES WOULD CAUSE UNACCEPTABLE ENVIRONMENTAL PROBLEMS; OR**
 - b) **THE BUILDING OR SITE IS NO LONGER CAPABLE OF PROVIDING AN ACCEPTABLE STANDARD OF ACCOMMODATION FOR EMPLOYMENT PURPOSES AND THIS CAN BE DEMONSTRATED BY A LACK OF DEMAND**
- 4.56 Many existing employment sites and buildings are located within the urban areas and this can result in pressure for their conversion or redevelopment for retail or residential uses. Many of the new sites allocated for employment uses in policy EM1 of the Plan are large and often located on the periphery of the urban areas. It is important, if the Council is to maintain and encourage further diversity in the local economy, that a range of employment sites and buildings in terms of size, type and location is maintained. Consequently the loss of existing buildings and premises within urban areas should be controlled to ensure the varied needs of businesses are met and in particular to provide opportunities for small and developing businesses to establish and grow. Retention of existing employment sites and buildings in urban areas will also assist in maintaining mixed land uses to maximise choice for people to live and work in close proximity.
- 4.57 Whilst there are often opportunities for reusing older buildings and sites for other employment uses, it is recognised that in some cases this may not be appropriate. Where unacceptable traffic or other environmental problems have arisen, particularly in residential areas, through the continued use of a building or site for employment purposes and where such matters cannot be satisfactorily resolved, it may be appropriate to consider alternative uses which could

alleviate the problem.

- 4.58 In some cases it may not be possible to reuse buildings or sites for employment uses because their specific design or layout can no longer provide an acceptable standard of accommodation for modern employment purposes. In such cases it will need to be demonstrated that a comprehensive and realistic marketing exercise has been carried out to sell the premises for employment uses and that subsequently insufficient demand has been established. The extent of this exercise will vary, depending on the circumstances, but is likely to include a requirement to provide evidence of the duration that the premises have been available for sale on the open market, the sale price, the level of interest, offers made and details of any attempted sale by tender or auction.

SITE CONSIDERATION POLICIES

EMPLOYMENT DEVELOPMENT

POLICY EM6 EMPLOYMENT DEVELOPMENT WILL BE PERMITTED WHERE:-

- a) **THE AMENITY OF NEIGHBOURING PROPERTIES IS PROTECTED,**
- b) **ITS DESIGN IS ACCEPTABLE IN TERMS OF APPEARANCE, SCALE AND SITING,**
- c) **BOUNDARY TREATMENT PROVIDES EFFECTIVE SCREENING AND IS ACCEPTABLE IN TERMS OF VISUAL AMENITY,**
- d) **LANDSCAPING COMPLEMENTS AND ENHANCES ITS APPEARANCE,**
- e) **ACCESS FOR VEHICLES, IS SAFE AND CONVENIENT,**
- f) **ACCESS FOR PEDESTRIANS, CYCLISTS AND PUBLIC TRANSPORT, WHERE APPROPRIATE, IS SAFE, CONVENIENT AND INTEGRATED WITH EXISTING PROVISION,**
- g) **PARKING FACILITIES ARE IN ACCORDANCE WITH ADOPTED COUNCIL STANDARDS AS OUTLINED IN APPENDIX 7.**

- 4.59 Employment development can range from small extensions on existing premises to the development of new sites. Policy EM7 outlines those issues which will be taken into account in assessing the merits of a proposed employment development. Proposals which adversely affect the amenity of neighbouring properties by way of environmental pollution, including noise and smells, are of poor design or inadequate siting, will not be acceptable. Assessment of any proposal will also include consideration of matters relating to safety and security. Sympathetic and effective boundary treatment, together with good quality landscaping, can improve the setting and appearance of employment sites and make them more acceptable. This will include appropriate tree planting and, in large new developments, the provision of substantial belts of woodland where appropriate, reflecting the objectives of the Greenwood Community Forest. The use of native tree species will be preferred.

- 4.60 One of the main issues encountered with employment uses relates to the provision of adequate access, parking and servicing facilities. Heavy goods vehicles and other delivery lorries can create environmental problems, particularly in areas not specifically designed for industrial purposes. Problems with on-street parking, reversing into streets and other dangerous manoeuvres can be detrimental to the free and safe flow of traffic. All employment developments must therefore have adequate on-site parking and servicing facilities and a safe and satisfactory access so as not to compromise highway safety. With the exception of the Sherwood Park Enterprise Zone which has its own standards, parking provision should be in accordance with adopted Council standards as outlined in Appendix 7. Development proposals should provide links to, and integrate with, established cycleways and footpaths adjacent to sites and on larger sites should facilitate convenient access and circulation for buses.

BUSINESSES IN RESIDENTIAL AREAS AND PROPERTIES

POLICY EM7 BUSINESS ACTIVITIES WITHIN RESIDENTIAL AREAS OR IN RESIDENTIAL PROPERTIES WILL BE PERMITTED WHERE THEY WILL NOT ADVERSELY AFFECT AMENITY, BY REASON OF NOISE OR OTHER ENVIRONMENTAL POLLUTION OR BY DISTURBANCE FROM VISITS TO THE SITE.

- 4.61 For many people there are advantages in working from home and many businesses have begun in this way. The use of information technology makes this option increasingly attractive. Depending on the type of activity, small businesses can operate in residential properties without detriment to the amenity of neighbours.
- 4.62 Where planning permission is required for the operation of a business in a residential property or within a residential area, the Authority must be satisfied it will not cause any environmental problems through noise and general disturbance from the use itself or from pedestrians, cyclists or motorists visiting the site. In addition, in accordance with policy ST1(c), proposals must not result in a significant increase in the number of vehicles visiting the site or the attraction of large delivery vehicles which could adversely affect the amenity and highway safety of the area. A temporary planning permission may be issued in the first instance to enable the Authority to assess further the impact of the development on the locality. The Authority may also wish to control, by condition, such issues as the extent of the business, the hours of operation, the type of machinery to be used and the number and type of motor vehicles to be operated from the site. Further details on these issues are contained within Supplementary Planning Guidance 4 published separately by the Council.

CHAPTER 5 : HOUSING

INTRODUCTION

- 5.1 A key purpose of this Local Plan is to ensure that housing needs in Ashfield are catered for through to year 2011. At present the District contains a wide range of housing types, concentrated in the three main towns, and within the larger settlements to the west of the M1 motorway.
- 5.2 Projected increases in the number of households, arising from increased numbers of single elderly people, rising divorce rates and changed styles of living, including younger people living alone, will result in the need for a substantial additional housing supply over the plan period. Whilst the implementation of the 1995 Local Plan has resulted in some of this housing supply being met, new housing sites need to be found especially in the south of the District, at Hucknall.
- 5.3 Whilst most new housing will continue to be provided by the private sector, the Council has a responsibility to ensure that the housing needs of all its residents are met, and therefore the provision of "affordable" housing will be encouraged throughout Ashfield.

CENTRAL GOVERNMENT ADVICE

- 5.4 PPG1 'General Policy and Principles' includes three guiding principles of sustainable development, the encouragement of mixed uses and high quality design. With regard to housing, the PPG advises local authorities to allocate the maximum amount of housing to previously developed sites within urban areas and to provide a mixture and range of types of housing to meet the increasingly varied housing requirements.
- 5.5 PPG3 'Housing' requires local planning authorities to meet the housing requirements of the whole community, including those in need of affordable and special needs housing. The PPG promotes the re-use of urban land in preference to the development of greenfield sites. Authorities should create more sustainable patterns of development in order to reduce car dependence by facilitating more walking and cycling and by promoting public transport linkages between housing and jobs.
- 5.6 Circular 6/98 'Planning and Affordable Housing' states that "...the community's need for affordable housing is a material planning consideration", and advises local authorities to define what they regard as affordable housing and indicate how many affordable houses need to be provided throughout the plan area.
- 5.7 PPG13 'Transport' advances the concepts contained in PPG1 and advises that new housing should, wherever possible, be located so as to provide a choice of means of travel to other facilities. Regional Planning Guidance for the East Midlands (RPG8) repeats these themes in that it stresses the need to concentrate development in or adjacent to existing urban areas and co-ordinate development with transport policies to help achieve sustainable development.
- 5.8 The DETR paper 'Planning for the Communities of the Future' outlines the challenge of finding environmentally sensitive long-term solutions to our housing requirements by making the best use of previously developed sites in order to minimise development in countryside areas. It repeats the need to ensure that a mix of housing types and densities are provided to meet the different requirements of households.

STRUCTURE PLAN REVIEW

- 5.9 The Nottinghamshire Structure Plan Review, policy 4/1, sets the scale of housing provision over the plan period for Ashfield at 8,550 dwellings. Of this figure 3,000 are to be provided in the South Nottinghamshire Sub-Area part of Ashfield, i.e. Hucknall, with the remaining 5,550 in the remainder of the District.

- 5.10 Policy 4/2 of the Structure Plan Review states that provision will be made in local plans for affordable housing in both urban and rural areas through policies which facilitate affordable housing where there is a demonstrable need.
- 5.11 Policy 4/3 states that local plans should contain policies which facilitate development at as high a density as is compatible with the characteristics of the site and which indicate types of location where higher densities may be appropriate, including locations near public transport nodes and in corridors well served by public transport.

HOUSING OBJECTIVES

- 5.12 a) To provide an adequate supply of housing land in appropriate locations to meet the Structure Plan Review provision to 2011.
- b) To provide for a range of housing sites both in size and quality.
- c) To ensure new housing development is concentrated in the Main Urban Areas and allow for limited development in the Named Settlements.
- d) To maximise the use of previously developed sites.
- e) To encourage higher density dwelling provision close to town centres and public transport facilities.
- f) To minimise the amount of new housing development in areas of countryside.
- g) To meet the affordable housing needs of the District.

HOUSING LAND REQUIREMENT

	Hucknall (South Notts. Sub- Area)	Rest of Ashfield (West Notts. Sub-Area)	District Total
1. Structure Plan Review requirement, 1991-2011	3,000	5,550	8,550
2. Houses developed, 1991-2000	935	3,157	4,092
3. Houses to be developed, 2000-2011, (1 minus 2)	2,065	2,393	4,458
4. Housing provision on small sites (including conversion and change of use) 2000-2011			
a) with planning permission, at 30.11.00	44	216	260
b) estimated additional development (2000- 2011)	42	153	195
5. Housing provision on large sites, 2000- 2011			
a) with planning permission at 30.11.00	447	910	1,357
b) additional land identified in policy HG1	1,675	1,548	3,223
c) redevelopment *	0	-34	-34
d) windfall allowance	50	150	200
6. Total housing provision, 2000 –2011 (4a + 4b + 5a + 5b + 5c + 5d)	2,258	2,943	5,201
7. Balance of requirement/provision 1991- 2011 (6 minus 3)	193	550	743

****Redevelopment proposal for 14 bungalows, following demolition of 48 bedsits in Sutton-in-Ashfield.***

- 5.13 Table 5.1 above details the number of dwellings to be provided for in the District as identified in the Structure Plan Review for the period 1991-2011. The table indicates for the period 2000 to 2011 that Hucknall (South Notts. Sub-Area) needs to provide for 2,065 dwellings, and the rest of the District (West Notts. Sub-Area) needs 2,393 dwellings.
- 5.14 The table shows the potential sources of those dwellings arising from the likely dwelling

provision on small sites, comprised of developments of less than 10 dwellings, for the period 2000 to 2011, together with dwelling provision on larger sites, both in the form of existing planning permissions and additional development sites proposed in this Local Plan Review.

- 5.15 The total proposed dwelling provision is therefore as indicated in row 6 of table 5.1, and amounts to 2,258 dwellings in Hucknall and 2,943 in the Rest of Ashfield. When considered with the number of dwellings already built within the period 1991-2000, the Local Plan Review suggests a limited additional provision of 193 dwellings in Hucknall and 550 in the Rest of Ashfield. This amounts to an excess of the Structure Plan Review requirements of 6% for Hucknall and 10% for the Rest of Ashfield providing flexibility in terms of a range and choice of sites.

HOUSING LAND SUPPLY

HOUSING LOCATION STRATEGY : A SEQUENTIAL APPROACH

- 5.16 The Ashfield Local Plan Review has adopted a "sequential" approach to residential site identification. This is based on Structure Plan Review policy and government advice that plans should identify land within urban areas as a priority, followed by sites adjoining urban areas and finally, only when the first two options have been exhausted, to consider sites elsewhere. The following priorities have therefore been applied to site identification:-

- a) **Main Urban Areas:-** The Main Urban Area boundaries were established in the adopted Local Plan. Sites within these areas have been considered as a priority. A detailed urban capacity study has been carried out, in relation to all undeveloped land in the urban areas in order to identify potential development sites. Full details of this study are available in Technical Paper No.1: 'Urban Capacity Study'. This includes a review of sites identified as protected open areas, open space and allotments. The general loss of all open spaces within the urban area was not considered to be acceptable, based on an assessment of open space needs and the current levels of provision. In the case of allotments only those which have demonstrably fallen out of use, or which can be managed to provide sufficient plots in the locality will be considered. The highest priority has been given to sites which are currently derelict and underused.
- b) **Adjoining Main Urban Areas:** The adopted Local Plan rejected the need to identify such sites on the basis that the existing urban areas could contain all land requirements. This is not now the case and therefore sites which adjoin the Main Urban Areas have been considered. In some cases, particularly around Hucknall and parts of Kirkby-in-Ashfield, such areas lie within the Green Belt. The criteria for Green Belt land release has been outlined previously. Provided such criteria are met, the release of Green Belt or Countryside sites well related to and adjoining the urban area is considered preferable to the loss to development of Green Belt or Countryside sites beyond the urban edge.

Sites on the urban edge should be capable of access to existing infrastructure and priority is given to sites which relate well to the urban area and provide logical extensions and "rounding off" to defensible physical boundaries. Such sites are unlikely to lead to pressure for additional future land releases or extension beyond newly identified boundaries.

The location of sites within, or adjoining, Main Urban Areas, which are well related to existing and proposed facilities, in particular to public transport, town centres and major employment sites are preferred. Sites within walking or cycling distance of such facilities will be regarded as particularly important.

- c) **Beyond Main Urban Areas:** It has not been necessary to identify sites in these locations where less favourable access to existing infrastructure and facilities would make integration into an expanded urban area more difficult. It is not the intention of the strategy to identify sites as "freestanding settlements" which would raise demands for the provision of a wide range of substantial (and large scale) associated facilities including sites for shops, schools, leisure and community use which should more appropriately be

located in existing urban areas and capable of use by the wider community.

- d) Named Settlements: The adopted Local Plan identified the areas of Selston, Jacksdale and Underwood as capable of accepting limited development. This Local Plan Review has extended the range of Named Settlements to include New Annesley, Bestwood and Brinsley. It is not the intention to identify major sites for development in these settlements but some limited areas of housing are considered appropriate.

HOUSING LAND ALLOCATIONS

HG1 RESIDENTIAL DEVELOPMENT WILL BE PERMITTED ON THE SITES LISTED BELOW AS SHOWN ON THE PROPOSALS MAP:-

		Gross Housing Area (Hectares)
Hucknall		
Ha	EAST OF NOTTINGHAM ROAD	5.4
Hb	BROOMHILL FARM	11.8
Hc	LIME TREE AVENUE/FARLEYS LANE	2.7
Hd	POLPERRO WAY	0.6
He	HIGH LEYS ROAD*	1.1
Hf	WATNALL ROAD	0.9
Hh	THE BRICKYARD	0.7
Hi	PORTLAND ROAD (former Hucknall Colliery)*	5.1
Hj	GARDEN ROAD	7.0
Hn	OGLE STREET	0.2
Ho	SOUTH OF PAPPLEWICK LANE	22.1
Hp	LINBY ROAD	0.6
Hr	HOLBECK ROAD/LINBY WALK	0.9
Ht	PARK DRIVE*	3.1
Hu	BYRON STREET	0.8
Hv	STATION TERRACE	0.2
Hw	BROOMHILL COURT, BROOMHILL ROAD*	0.2
Kirkby-in-Ashfield		
Ka	LINDLEYS LANE	13.9
Kd	BEECH AVENUE	0.7
Kf	OCCUPATION LANE	0.7
Kh	LANE END*	1.5
Ki	DIAMOND AVENUE	2.1
Kj	EDWARD STREET/ASHWOOD AVENUE*	1.5
Kk	LOWMOOR ROAD/MARLBOROUGH ROAD*	0.7
Kn	CAVENDISH CLOSE	1.4
Ko	CROMFORD ROAD	0.5
Kp	MAIN ROAD	1.7
Kq	SKEGBY ROAD	1.7
Kr	BIRDS LANE	2.6
Sutton-in-Ashfield		
Sa	ALFRETON ROAD/CALLADINE PARK*	8.0
Sb	OFF CROWTREES DRIVE*	0.4
Sd	CALLADINE PARK – CENTRAL*	2.6
Se	HILLSBOROUGH AVENUE	4.8
Sf	OFF THE AVENUE	0.7
Sh	ALFRETON ROAD SOUTH	1.4
Si	JEPHSON ROAD	1.1
Sj	KIRKBY FOLLY ROAD*	0.7

SI	MOWLANDS CLOSE/ SHEEPWASH LANE	3.1
So	THE TWITCHELL	0.4
Sp	STONEY STREET	0.9
Sq	CARSIC LANE/DAVIES AVENUE	0.4
Sr	ASHFORD RISE	0.7
Ss	STONEYFORD ROAD/MOUNT PLEASANT	1.2
Sx	STONEYFORD ROAD	1.0
Sy	NORTH CARSIC ROAD	0.5
Sab	MEDEN BANK/BRAND LANE*	0.6
Saf	OFF CROSS LANE, HUTHWAITE*	4.8
Sag	COLUMBIA STREET/MILL LANE	1.3
Saj	COMMON ROAD - NORTH	1.3
Sak	BLACKWELL ROAD/LITTLE LANE*	1.3
Sal	HUTHWAITE ROAD	1.3
Sam	SKEGBY ROAD, HUTHWAITE*	0.4
San	KINGS MILL ROAD EAST	2.8

Named Settlements

Selston

Na	INKERMAN STREET/ALMA ROAD*	0.9
Ne	MANITOBA WAY*	1.4
Ni	ALFRETON ROAD*	0.5

Jacksdale

Nf	WESTDALE RD/RUTLAND RD	0.9
Ng	WESTDALE ROAD	2.1

New Annesley

Ni	MOSELEY ROAD*	0.8
----	---------------	-----

Bestwood

Nj	OLD MILL CLOSE (WEST)	0.7
Nk	OLD MILL CLOSE (EAST)*	1.6

Rural Area

Ra	ANNESLEY HALL*	3.8
Rc	HARLOW WOOD - SOUTH*	4.5
Rd	FACKLEY ROAD, TEVERSAL*	0.5

*All or part of site with planning permission at 30th November 2000

DETAILED SITE REQUIREMENTS IN THE SUPPORTING TEXT AND SITE BRIEFS IN APPENDIX SIX WILL BE NEGOTIATED AND SECURED, AS APPROPRIATE, BY PLANNING CONDITIONS OR A PLANNING OBLIGATION.

- 5.17 Policy HG1 above allocates residential sites which have been identified through the sequential approach and which minimise the loss of Countryside and Green Belt areas. Appendix 5 provides a detailed table indicating gross site area, gross housing area, net housing area, minimum density requirements and potential number of dwellings for each of the sites listed in policy HG1. The policy contains sites both with and without planning permission, details of which are referred to below.

HOUSING SITES WITH PLANNING PERMISSION

- 5.18 Housing sites with planning permission at 30th November 2000 on all, or part of the allocations listed in policy HG1 are marked with an asterisk. Existing sites with planning permission represent a substantial proportion of the dwelling requirements, particularly in Kirkby-in-Ashfield and Sutton-in-Ashfield as indicated in Table 5.1. Sites which have been granted planning permission since 30th November 2000 are included as new allocations and are referred to in the site descriptions given below. Where a site is under construction, the site area referred to in policy HG1 is that remaining on 30th November 2000. However, sites of ten dwellings or less remaining to be constructed at that date are omitted from the policy.
- 5.19 It is generally assumed that land which has the benefit of planning permission for residential purposes in the Main Urban Areas and Named Settlements will in principle remain suitable for such purposes throughout the Plan period.

HOUSING SITES WITHOUT PLANNING PERMISSION

- 5.20 In addition to the sites with planning permission a number of sites have been allocated in policy HG1 which do not have a planning permission. Some of these sites have been previously allocated in the adopted Ashfield Local Plan and can be considered as existing commitments. The remaining sites are new allocations. In identifying sites, account has been taken of their physical characteristics, any development constraints, service provision and accessibility, together with their general suitability in relation to the overall strategy of the plan.

HOUSING DEVELOPMENT CONTRIBUTIONS TO OTHER FACILITIES

- 5.21 In considering the allocation of development land the Local Plan Review recognises the pressures for new facilities that will arise both from within new development and cumulatively from the expansion of the settlement as a whole. The potential to provide new or improved facilities can come from these new developments. In this respect individual sites could offer potential benefits to the area in a number of ways for example:
- a) By making provision of new open space, landscaping and woodland planting.
 - b) By improving access to countryside, river corridors etc. including new footpaths and cycleways and in some instances bridleways.
 - c) Through the provision of new leisure/recreation facilities, e.g. playing fields and community buildings.
 - d) By improvements to public transport facilities, providing the opportunity for modal changes e.g. park and ride, bus stops, bus turning areas and shuttle bus services.
 - e) The provision of affordable housing.
 - f) Providing funding for the improvement of town centres, e.g. Hucknall Inner Relief Road/pedestrianisation schemes.
 - g) By improvements to school provision.
- 5.22 Sites have not however been allocated on the basis of their ability to provide specific facilities. All sites must be capable of development and be acceptable within the overall strategy prior to any considerations of additional benefits agreed through the use of planning obligations. Equally where a number of large sites are likely to create a collective requirement for improvement to an area it will be expected that all sites must contribute (pro-rata) to this provision. In Hucknall one of the key policies of the Structure Plan Review is to promote development in the Public Transport Corridor. The Structure Plan Review also identifies Hucknall as one of four major District Centres in the South Nottinghamshire sub area to be enhanced and expanded. In this respect most housing developments in Hucknall will be expected to contribute to improvements to the public transport corridor including the provision of the Hucknall Inner Relief Road and pedestrianisation of the High Street as a major element of the enhancement of the town centre. These matters are considered in more detail in policies HG4, HG6, TR6, RC1 and RC4.

SUMMARY OF HOUSING ALLOCATIONS

Hucknall

- 5.23 Site HG1Ha adjacent to Nottingham Road has been excluded from the Green Belt, and was formerly used as a zoo. The site has strong defensible boundaries, therefore the development of the site for housing purposes would not lead to further expansion of the urban area. It is contained by housing to the northern, southern and partly western boundaries, with the Robin Hood Line forming the eastern boundary. The site is also well located in relation to the Hucknall - Nottingham Public Transport Corridor. Development of this site would not prejudice the purpose of the Green Belt to maintain the important open break between Hucknall and Nottingham. Detailed considerations relating to this site are shown in Site Brief H1 in Appendix 6.
- 5.24 Site HG1Hb at Broomhill Farm has been excluded from the Green Belt and comprises part of an agricultural holding. The site is contained by the existing built urban framework to the north, east and west while potential encroachment into the countryside and any affect on the open break between Hucknall and Nottingham is minimised by the presence of a pronounced ridge line to the south of the site which forms a revised boundary for the Green Belt. Therefore, the development of this site would not prejudice the purpose of the Green Belt to maintain this important open break. The site is well located in relation to the Public Transport Corridor. Detailed considerations relating to this site are shown in site brief H2 in Appendix 6.
- 5.25 Site HG1Hc off Lime Tree Avenue has been excluded from the Green Belt. It is considered that this triangular site is well contained on two sides by existing residential development and that subject to the provision of supplementary landscaping adjacent to its third and southern boundary, development would not compromise the important open break to the south between Hucknall and Nottingham. The preferred means of access to this site will be from the end of Farleys Lane. Alternative access points will be considered if these are acceptable to the Highway Authority. Contributions will be negotiated towards improvements to educational facilities in accordance with paragraph 8.55 and Policy HG1.
- 5.26 Site HG1Hd at Polperro Way is allocated for development in the adopted Ashfield Local Plan and represents a logical completion of the existing development at Common Farm.
- 5.27 Site HG1He, off High Leys Road, and in close proximity to the primary and secondary schools comprises an area of unused land and has the benefit of planning permission. The Watnall Road site HG1Hf, lies adjacent to site, HG1He, and is an area of former private allotments now largely abandoned. Access to the site would be directly off Watnall Road and will require the removal of one residential property. To ensure acceptable visibility onto Watnall Road, the access road should be located on the northern edge of this plot.
- 5.28 A small site at the Brickyard, HG1Hh, is allocated in the adopted Ashfield Local Plan for residential development and has been retained in this review.
- 5.29 Site HG1Hi off Portland Road represents approximately 50% of the site area of the former Hucknall No.1 Colliery Site which closed in the mid-1980's. The site has remained largely undeveloped, and because of its location close to the town centre, to the Robin Hood Line, and NET stations is considered appropriate for high density development in accordance with policy HG3. The site is likely to be contaminated, and will require suitable treatment before development. This site now has the benefit of planning permission.
- 5.30 The site HG1Hj, off Garden Road, comprises part of a large area of allotment gardens. It is considered that, because of existing under-use for allotment purposes, potential exists for a viable re-organisation involving the relocation of existing plot users into an area to be retained as allotments to the south of the allocation. The satisfactory accommodation of these existing plot-holders will be a pre-requisite of any development. Detailed considerations relating to this site are included in site brief H3 in Appendix 6. Technical Paper No.6: 'Allotments' also provides background information.

- 5.31 Site HG1Hn fronting Ogle Street is a town centre site, and the proposal would involve a redevelopment or conversion of the former Co-operative Store buildings. The new site owner has indicated intentions to pursue a high density housing/commercial project on this important town centre site.
- 5.32 Site HG1Ho to the south of Papplewick Lane represents the largest new allocation within Hucknall. The site has strong defensible boundaries, therefore the development of the site for housing purposes would not prejudice the purpose of the Green Belt. The site, which has been excluded from the Green Belt, is mainly in use for agricultural purposes, but is in close proximity to the town centre and to public transport facilities, including the Robin Hood Line Station, and the proposed NET tramway terminus. It is contained to the north and west by existing housing and to the south by the former colliery spoil heap, now a golf course and the Leen Valley. Development of this site will need to incorporate improved and extended recreational facilities and pedestrian access through the site to an enhanced Leen Valley corridor to the east. The overall site development includes the Wigwam Lane playing fields, although the provision of new multi-use recreational facilities on part of the existing football pitches, and the provision of extensive new pitches elsewhere within the site, will be an essential part of the overall site development. Detailed considerations of this key site are shown in site brief H5 in Appendix 6.
- 5.33 Site HG1Hp off Linby Road involves the redevelopment of an area of privately owned and generally poorly used allotment gardens, well located in relation to the town centre and public transport corridor. See Technical Paper No.6: 'Allotments'. Site HG1Hr, again served off Holbeck Road, is partially occupied by a car dismantling yard.
- 5.34 Site HG1Ht at Park Drive has the benefit of planning permission and will involve redevelopment of a factory site within a residential area near to the Town Centre. Site HG1Hu, Byron Street will involve the redevelopment of a former factory unit in close proximity to the town centre. Site HG1Hv involves the redevelopment of existing buildings in close proximity to the town centre and adjacent to the Robin Hood Line station. Site HG1Hw at Broomhill Road has the benefit of planning permission.
- Kirkby-in-Ashfield
- 5.35 Site HG1Ka, off Lindleys Lane, has been excluded from the Green Belt, and comprises a large parcel of land which will be accessed primarily from Kingsway, with a secondary access off Lindleys Lane. The site is currently used for agricultural purposes, although part is occupied by general industrial premises which will need to be re-located. The south and west boundaries are defined by the Robin Hood Line, much of which is on a substantial embankment providing a distinct physical feature and logical revised Green Belt boundary. The site is close to the town centre, and to the Robin Hood Line Station. Contributions towards improved recreational facilities on the adjacent Kingsway Park and the addition of public access land in connection with the Portland Park SSSI to the South and west will be required. Detailed considerations are given in Site Brief H6 in Appendix 6.
- 5.36 Site HG1Kd comprises a small unused area of land off Beech Avenue. Site HG1Kf off Occupation Lane, is an allocation retained from the adopted Ashfield Local Plan (1995).
- 5.37 Site HG1Kh at Lane End, has the benefit of planning permission and is located close to both the Kirkby Station on the Robin Hood Line and the town centre.
- 5.38 The site HG1Ki at Diamond Avenue, is at present allotment land, part of which was allocated on the adopted Ashfield Local Plan. Many of the allotments are no longer cultivated, and the intention is that remaining plot-holders will be relocated to the westernmost 24 allotments which are to remain on this site. The site is close to the town centre, and to public transport facilities. The satisfactory relocation of existing plot-holders will be a pre-requisite of any development. See Technical Paper No.6: 'Allotments'.
- 5.39 Sites HG1Kj, and HG1Kk are located in proximity to Lowmoor Road, and all have the benefit of planning permission, are well located within the Main Urban Area, and will utilise unused land.

Development on both sites has commenced.

- 5.40 The remaining five sites referred to in the following paragraph 5.41 are located in the Annesley Woodhouse/Nuncargate/Kirkby Woodhouse area to the south of the main town, and are moderate in size. All the sites are well contained within the built up area.
- 5.41 HG1Kn Cavendish Close, an unused parcel of land, and HG1Ko Cromford Road, which will complete the Longhill Rise housing area, are both retained from the adopted Ashfield Local Plan; HG1Kp Main Road is currently in agricultural use, but is enclosed by development and any planning permission will be subject to the provision of 0.5ha of open space fronting Main Road. HG1Kq Skegby Road has the benefit of planning permission subject to a planning obligation regarding contributions towards open space provision, and HG1Kr Birds Lane is a parcel of agricultural land enclosed by existing development on all sides. The Birds Lane site will require suitable improvements to visibility splays at the Birds Lane/Main Road junction, and to the one-way section of Birds Lane including the provision of a footway linking Skegby Road to the existing footway on Birds Lane.

Sutton-in-Ashfield

- 5.42 A large number of sites, many modest in scale, are proposed for Sutton-in-Ashfield, which is the largest urban area in Ashfield. This is in part, at least, a reflection of the success of the urban capacity exercise, in identifying pockets of unused and underused land. Eleven of the thirty-one sites being advanced already have the benefit of planning permissions, as at 30th November 2000.
- 5.43 Sites HG1Sa - HG1Sf are all located in or immediately adjacent to the rapidly developing Calladine Lane residential neighbourhood located between Alfreton Road to the west, Kirkby Road to the east and a new industrial estate to the south. Pedestrian and cycle routes will enhance direct linkages between this area and the town centre to the north-east and areas of countryside and the local comprehensive school to the south. With the exception of Hillsborough Avenue (HG1Se), which was allocated in the adopted Local Plan, and site HG1Sf, off The Avenue these sites all have the benefit of planning permission and development is proceeding.
- 5.44 HG1Sh is located to the south-west of the Calladine Lane area and is enclosed by development and/or main roads. The site will require access improvements involving land in adjacent ownership before development can proceed. The retention of hedgerows and trees on the site boundary of HG1Sh, and the retention of footpath links will be required.
- 5.45 Site HG1Si is an elongated area of disused allotments located between the Leamington housing estate and the A38 Sutton Bypass and which will require access improvements, whilst site HG1Sj is a parcel of land between existing housing and the Robin Hood railway line which now has planning permission.
- 5.46 Site HG1Sl off Mowlands Close and Sheepwash Lane is part of a larger allocation for development in the adopted Ashfield Local Plan, part of which has been implemented.
- 5.47 Site HG1So, off the Twitchell is a modest site with planning permission located close to the town centre. Site HG1Sp at Stoney Street is a former industrial site, occupied by a substantial derelict, building and previously allocated in the adopted Ashfield Local Plan. Site HG1Sq off Carsic Lane previously had the benefit of planning permission which has now lapsed.
- 5.48 Site HG1Sr off Ashford Rise is another site identified in the adopted Ashfield Local Plan, as is Site HG1Ss off Stoneyford Road. Both the sites are close to, and highly accessible to the town centre.
- 5.49 Sites HG1Sx and HG1Sy at Stoneyford Road and off Carsic Road abut each other, the former site being currently occupied by a concrete manufacturer in the process of relocation while the latter area of open land in agricultural use represents a logical rounding off of the adjacent urban area.

- 5.50 Development of site HG1Sab at Meden Bank, Stanton Hill is now proceeding
- 5.51 Sites HG1Saf to HG1Sam are located in Huthwaite. Sites HG1Saf to HG1Sak were identified in the adopted Ashfield Local Plan (1995), and development of HG1Sak is now proceeding. HG1Saf has the benefit of planning permission and site HG1Sal, at Huthwaite Road is allocated for housing conditional upon improvements to recreation facilities on site RC3Sm and RC3Sl. Site HG1Sam at Skegby Road, Huthwaite has the benefit of planning permission and involves the redevelopment of a redundant pub and adjacent vacant land. Access will be from Skegby Road.
- 5.52 Site HG1San at Kings Mill Road East/Mansfield Road is allocated as part of a comprehensive special development site details of which are included in policy SH10 In the Shopping chapter and site brief S1 in Appendix 8.

Named Settlements

- 5.53 A small number of sites are proposed for development within the Named Settlements of Selston, Jacksdale, Underwood, New Annesley and Bestwood. These are as follows:-

Selston

- 5.54 In Selston three sites are proposed for housing development. Site HG1Na at Inkerman Street/Alma Road was occupied previously by a car dismantling business, and following the grant of planning permission for residential development has been removed from the Green Belt.
- 5.55 Site HG1Ne, off Manitoba Way, has the benefit of planning permission and involves the potential redevelopment of part of an established textile factory, together with a parcel of adjacent unused land. Site HG1Ni at Alfreton Road has also been granted planning permission.

Jacksdale

- 5.56 In Jacksdale site HG1Nf at Westdale Road and Rutland Road combine to provide a site within the village, whilst the larger site HG1Ng, also off Westdale Road comprises land formerly held for a new primary school.

New Annesley

- 5.57 In New Annesley site HG1Ni, Moseley Road, recognises the existence of an extant residential planning permission which was technically commenced.

Bestwood

- 5.58 Sites in Bestwood will contribute to the housing needs of the South Notts. Sub-Area. Site HG1Nj at Old Mill Close represents a logical extension to an adjacent site HG1Nk which has the benefit of a previous planning permission. The new site is currently occupied by an industrial business involved primarily in the manufacture of slug pellets. It is understood that this firm is considering relocation. Redevelopment of this site would produce substantial visual benefits by the removal of tall silos and other plant.

Rural Areas

- 5.59 Within the rural area site HG1Ra at Annesley Hall, relates to a longstanding planning permission where some site works have commenced in connection with a package of development aimed at securing the future of a number of important listed buildings. In total, including the re-use and extension of existing buildings, previous permissions allow for some 29 dwellings of which 12 lie within the allocated site. A detailed design brief relating to the development opportunities for Annesley Hall and associated land has been prepared

separately by the Council in relation to this important site.

- 5.60 Site HG1Rc, South of Harlow Wood is now under construction. Site HG1Rd at Fackley Road, Teversal represents modest infilling between two cul-de-sacs of former British Coal housing, which will also create an improved access to an adjacent leisure and recreational facility. This site now has the benefit of planning permission.

OTHER RESIDENTIAL DEVELOPMENT IN THE MAIN URBAN AREAS AND NAMED SETTLEMENTS

POLICY HG2 IN THE MAIN URBAN AREAS AND NAMED SETTLEMENTS, RESIDENTIAL DEVELOPMENT ON LAND NOT ALLOCATED OR SAFEGUARDED FOR OTHER PURPOSES WILL BE PERMITTED.

- 5.61 This policy allows for development in the Main Urban Areas and Named Settlements additional to that provided for in policy HG1. The policy also allows for new small sites and for windfalls, comprising as yet unidentified sites of 0.4 hectares or more, to be developed in the Main Urban Areas and Named Settlements during the Plan period provided they are not allocated or safeguarded for other purposes within this Local Plan, for example allocated for employment uses or safeguarded open space areas. This accords with strategic policies ST2 and ST3, which aim to concentrate new development in the Main Urban Areas and to allow limited development in the Named Settlements.
- 5.62 Table 5.1 has shown that, based upon an assumed proportion of past completion rates, and the detailed urban capacity exercise undertaken, some 195 or so dwellings will be completed on as yet unidentified small sites, including changes of use and conversions, in the period 2000-2011. Of these, approximately 42 are expected in Hucknall and the remainder in the Rest of the District, particularly in the Main Urban Areas of Kirkby-in-Ashfield and Sutton-in-Ashfield.
- 5.63 Some of the large sites completed since 1995 in Kirkby-in-Ashfield and Sutton-in-Ashfield were not allocated in the adopted Ashfield Local Plan, i.e. they are classified as windfalls. It is likely that further windfall sites may become available in addition to those sites identified in policy HG1. A windfall allowance of 200 has therefore been included in the housing supply figures in Table 5.1.

HOUSING DENSITY

POLICY HG3 PROPOSED RESIDENTIAL DEVELOPMENT ON SITES OF 0.4 HECTARES AND GREATER WITHIN THE WALKING DISTANCES INDICATED BELOW FROM DISTRICT SHOPPING CENTRES, ROBIN HOOD LINE STATIONS OR NOTTINGHAM EXPRESS TRANSIT RAIL STOPS WILL BE PERMITTED SUBJECT TO THE FOLLOWING MINIMUM NET DENSITY REQUIREMENTS.

- a) 40 DWELLINGS PER HECTARE WITHIN 400 M.
- b) 34 DWELLINGS PER HECTARE WITHIN 1 KM.
- c) 30 DWELLINGS PER HECTARE ELSEWHERE

- 5.64 This policy aims to assist in the Council's strategy to ensure the most efficient and economic use of land in the District and reflects the requirements of PPG3 and Structure Plan Review Policy 4/3. Developments carried out at a higher density in accordance with this policy will bring more people within walking distance of the District Shopping Centres, Robin Hood Line Stations and proposed NET tram stops. This will encourage a subsequent reduction in private car journeys and improved usage of these services. The policy will also assist in encouraging the development of an increased number of smaller and more affordable properties. As such the policy reflects the advice contained in the Department of the Environment, Transport and the Regions, publication: 'Planning for Sustainable Development: Towards Better Practice', October 1998, which in Section 4 explains the benefits of increasing urban densities.
- 5.65 Policy HG3 indicates the overall minimum housing density levels that will be expected across

any site over 0.4 hectares. This will make more efficient use of land and in particular encourage a greater density of development around District Shopping Centres and major public transport nodes on public transport corridors. A variety of densities will be permitted within each site, so long as the average density meets the required density criterion for the whole site. It is recognised that it may not always be possible or appropriate to achieve the minimum density requirements. Densities of 30 dwellings per hectare or over may not be compatible with a site or its surroundings. This may for instance include the presence of physical constraints such as site topography and landscape features or capacity constraints such as vehicular access and drainage. A lower density may also be more appropriate to accord with a particular character of an area such as a village or conservation area. There may also be cases where it is appropriate to allow development at a lower density to contribute towards providing a range and choice of house types in accordance with PPG3. Proposals which significantly exceed the density requirements in the policy may also be appropriate where design solutions can be demonstrated within the scope of residential design standards.

- 5.66 Walking distances in the two density zones have been established at 400 metres within which it is likely that many people will choose to walk to District Shopping Centres and rail stops, and 1 kilometre within which a smaller but still significant number of people are likely to choose to walk. The 1 kilometre zone is also considered to be the principle catchment of the Public Transport Corridor. Outside of these two zones a higher proportion of people are likely to use a private car rather than walk and as such a lower target density is appropriate.
- 5.67 Walking distance should be measured as the shortest route on paths/footways with public access between the proposed residential development site and District Shopping Centres or existing or proposed rail stops. Proposed sites which do not fall wholly within the distance criteria specified will be considered according to the size of the site and the proportion of the site falling within the zone and the compatibility of the site with the general objectives of the policy.
- 5.68 Density levels for the two zones have been established through surveys of recent developments in Ashfield and reviews of best practice elsewhere. The lower density target figure of 30 dwellings per hectare is advised in PPG3. These have been set at a level which when implemented with other policies in the Ashfield Local Plan Review and supplementary guidance will ensure acceptable residential design standards are capable of being achieved without detriment to the environment.
- 5.69 Net residential density is measured as the number of individual dwelling units per hectare of land developed specifically for housing and directly associated uses. This includes access roads within the site, private garden space, car parking and incidental open space/landscaping. It does not include distributor roads, open space serving a wider area, significant landscape buffer areas and other facilities such as schools, shops and community buildings.
- 5.70 The increase in density resulting from the policy will require careful design. In some cases it may be appropriate to incorporate conditions removing the usual permitted development rights enjoyed by households in order to prevent over-development, or unsympathetic extensions.
- 5.71 Appendix 5 lists housing land allocations from policy HG1 and identifies the number of dwellings for each site, this information is then added in Table 5.1 to show the total supply of housing as opposed to Structure Plan Review land requirements. The dwelling totals in Appendix 5 either reflect the number of dwellings with planning permission or the expected number of dwellings following application of density requirements and targets on each site from policy HG3 as appropriate.

AFFORDABLE HOUSING

POLICY HG4

ON HOUSING DEVELOPMENT SITES OF ONE HECTARE OR MORE, OR 25 DWELLINGS OR MORE, THE COUNCIL WILL NEGOTIATE THE PROVISION OF A PROPORTION OF AFFORDABLE DWELLINGS ON THE SITE TO CONTRIBUTE TOWARDS THE OVERALL TARGETS FOR THE AREAS

SPECIFIED BELOW

**In Hucknall (South Notts. Sub Area)
18.5% OF DWELLINGS**

**In the Rest of the District (West Notts. Sub Area)
6% OF DWELLINGS**

**AFFORDABLE HOUSING WILL CONSIST OF THE FOLLOWING
IN ORDER OF PREFERENCE:**

- a) **DEVELOPMENT OF DWELLINGS IN CONJUNCTION WITH A REGISTERED SOCIAL LANDLORD OR THE COUNCIL.**
- b) **SHARED OWNERSHIP SCHEMES.**
- c) **PROPERTIES FOR SALE OR RENTAL AT AN AGREED SIZE MEASURED BY FLOORSPACE.**
- d) **A FINANCIAL CONTRIBUTION NEGOTIATED AND SECURED BY A PLANNING OBLIGATION TOWARDS THE OFF SITE PROVISION OF AFFORDABLE HOUSING AT AN AGREED LOCATION.**

5.72 PPG3 'Housing' sets out the Government's policy on how the planning system can contribute to the overall supply of affordable housing. This is further amplified in Circular 6/98 which provides a clearer framework for preparing local plan policies and practical advice on how affordable housing may be provided through negotiation with developers and others. Affordable housing encompasses both subsidised and open market housing designed for those whose incomes generally deny them the opportunity to purchase houses on the open market due to the local relationship between income and market price.

5.73 This local plan identifies in policy HG1 the sites suitable to meet the projected overall housing needs of the District arising from the Structure Plan Review to 2011. It therefore follows that the future needs for affordable housing in the District must be provided on these sites as they arise for development. One exception to this requirement relates to developments which are specifically being built to meet a recognised specialised housing need, such as sheltered housing for the elderly, where the Council will take into account the fact that such sites are usually small in size and unlikely to be appropriate for a mix of affordable and general sheltered housing units. Policy HG4 above provides the criteria against which the Council will negotiate for the provision of an element of affordable dwellings on new housing sites. There are a number of ways in which affordable housing can be achieved. In each case the Council will wish to explore the potential for provision in the priority order listed in the policy. Since the main requirement for affordable housing arises from lower income groups the need to provide housing for rent or shared ownership through Registered Social Landlords will be greater than through private sales of lower cost housing.

Affordable Housing Needs

5.74 In conjunction with the other Districts within the South Notts. Sub-Area the Council has undertaken detailed research into the need for affordable housing within the Nottingham conurbation. This work has been undertaken jointly with District planning and housing officers and the methodology has been endorsed by the Authorities involved. A predictive model has been developed to determine affordable housing needs based on the projected incomes of the new households likely to arise within the period to 2011 and taking into account current housing costs, the estimated costs of home ownership in relation to income and the amount of social and private rented housing stock likely to become available within the Plan period.

5.75 The model has indicated a 'residual' number of households who will be unable to afford the purchase of new houses on the open market or find sufficient alternative accommodation within current stock. This represents a need for about 7309 new affordable dwellings, across the whole conurbation, amounting to about 24% of outstanding new dwellings required by the

Structure Plan Review from 1996-2011. An apportionment within the Ashfield part of the South Notts. Sub-Area (Hucknall) indicates that about 479 (18.5%) of the new dwellings should be affordable. Application of the same model to the West Notts. Sub-Area indicates that for the Rest of Ashfield about 228 (6%) of the unbuilt dwellings should be affordable. Details of the affordable housing model and of typical affordable housing already provided within the District is contained in a Technical Paper No. 3 : 'Affordable Housing'.

Individual Sites Requirements and Future Monitoring

- 5.76 Policy HG4 provides an overall target figure for affordable housing need within each of the Structure Plan Review sub areas, but does not attempt to allocate a specific proportion of dwellings for any one site. This will be a matter for negotiation with individual developers on sites above the threshold size specified. However it is clear that all developments over the threshold size, with the exception of specialised housing needs referred to in paragraph 5.84, must provide an element of affordable housing if the overall target is to be achieved. A simple method would be to aim for each site to provide the % equivalent to the overall target figure. However on some sites, particularly those at a higher density, it is likely that a proportion of dwellings regarded as affordable may be in excess of the target figure and this may be offset by those sites which provide a lesser number of affordable dwellings. Equally on sites developed by Registered Social Landlords or the Council it is likely that all properties will be affordable.
- 5.77 The tables contained within Technical Paper No. 3 indicate the average build rate per annum for each of the two areas to meet the affordable housing targets. Annual house building monitoring will in future include an assessment of the number of properties built that are regarded as affordable from all sources to ensure that targets are being met. These figures will assist in an assessment of the need for affordable housing provision at regular intervals throughout the Plan period.

Rural Exceptions

- 5.78 No parts of the District have been identified as being sufficiently isolated from the Main Urban Areas and Named Settlements to be likely to justify the need for affordable housing in such locations. In general terms the need for specific housing provision outside these areas will be dealt with under the provisions of Policies EV1 and EV2.

Ways of Achieving Affordable Housing

- 5.79 Policy HG4 above indicates four ways in which affordable housing could be provided through negotiation with housing developers. The Council will wish to be satisfied that developers have considered all the options in the order of preference stated in the policy. In this respect the Council will endeavour to introduce, where appropriate, Registered Social Landlords who wish to promote schemes in the area of the proposed development and are willing to work in partnership with developers to achieve this.
- a) Registered Social Landlords (RSLs) represent one of the most important means of providing affordable housing. Councils are usually involved with RSL's by negotiating a % of future tenancies in new schemes to be nominated from the Council's housing register. Partnerships with private house builders can deliver either land, which RSL's can use for their own developments, or can build properties on behalf of RSL's using their funding sources. Land in Council ownership may be sold for private development with agreement for the provision of a proportion of affordable housing on the site. Partnerships are the most effective way of providing affordable housing and are more likely to leave control of the properties in the social housing sector ensuring continuity of provision in the future.
 - b) Shared ownership schemes represent a way of providing affordable housing by offering part of the value of the property for sale and the remaining portion as a 'rented' element. This allows tenants to purchase an element of the property with the prospect of completing a purchase at some future date.

- c) Properties sold or rented by developers at an appropriate price can be regarded as affordable. Technical Paper No.3 provides some examples of recently developed affordable homes within Ashfield. The relationship between the size of property and its sale/rental value is clear. Small dwellings, measured by total floorspace, can be regarded as affordable. The examples in the Technical Paper will be used as guideline to assess which small dwellings can be regarded as affordable within any new developments. In practice the density policy HG3 will ensure the provision of smaller properties on some sites which may be regarded as affordable. Existing properties converted for sale or rent will also be taken into account under this section of the policy. This will include building conversions to residential use and the re-use of former residential space, such as the conversion of space over shops in town centres.
- d) In some cases developers may prefer to contribute a sum, secured through a planning obligation, towards the provision of affordable housing elsewhere. While this is a legitimate means of achieving the overall targets it will clearly not be possible for all developments to use this method simply because no sites would be available for affordable housing. Therefore any agreement to fund "offsite" affordable dwellings must include the identification of the alternative site and the means by which this can be achieved - for example in partnership with the Council or RSL's. The Council does not wish to obtain funding for affordable housing without the agreed means to ensure its delivery.

SITE CONSIDERATION POLICIES

NEW RESIDENTIAL DEVELOPMENT

POLICY HG5

RESIDENTIAL DEVELOPMENT WILL BE PERMITTED WHERE:

- a) **THE AMENITY OF NEIGHBOURING PROPERTIES IS PROTECTED,**
- b) **THE DESIGN AND LAYOUT OF DWELLINGS MINIMISES POTENTIAL OVERLOOKING AND PROVIDES A REASONABLE DEGREE OF PRIVACY AND SECURITY,**
- c) **ADEQUATE PRIVATE GARDEN SPACE IS PROVIDED,**
- d) **BOUNDARY TREATMENT PROVIDES AN ACCEPTABLE STANDARD OF PRIVACY AND VISUAL AMENITY,**
- e) **ACCESS FOR VEHICLES, PEDESTRIANS AND CYCLISTS AND PUBLIC TRANSPORT WHERE APPROPRIATE, IS SAFE AND CONVENIENT AND INTEGRATED WITH EXISTING PROVISION,**
- f) **PARKING FACILITIES ARE PROVIDED IN ACCORDANCE WITH COUNCIL STANDARDS, AS OUTLINED IN APPENDIX 7.**
- g) **ITS DESIGN IS ACCEPTABLE IN TERMS OF APPEARANCE, SCALE AND SITING, AND**
- h) **LANDSCAPING COMPLEMENTS AND ENHANCES ITS APPEARANCE.**

- 5.80 Residential development can take many forms, depending upon such issues as the physical and topographical characteristics of the site, its location and the demand for particular dwelling types. In assessing the merits of a particular proposal, the above criteria will need to be satisfied.
- 5.81 It is essential that all new residential developments are designed to protect both those features worthy of retention and the amenity of neighbouring properties. The Authority will resist any development which has a seriously detrimental effect on neighbouring properties by reasons of overlooking, massing or overbearing impact. These effects can normally be overcome by the re-siting, reduction or re-orientation of the development.
- 5.82 The design and layout of dwellings should reduce the likelihood of overlooking, ensure a

degree of privacy, provide a reasonable outlook, and help in minimising the risk of crime as advised in PPG1 and Circular 5/94 'Planning Out Crime'. In this respect consultation will be carried out with the Architectural Liaison Officer of the Nottinghamshire Constabulary. The provision of satisfactory boundary treatment can help to create private areas and, with the use of good quality materials and sensitive design, provide interest in the street scene.

- 5.83 The main elements in creating an interesting, pleasing and safe environment are the siting, design and external appearance of dwellings. Developments should contain a variety of designs with varied building lines, where appropriate, and be constructed in good quality materials which reflect the character of the area. Each dwelling must have a satisfactory means of access and adequate off-street parking space to avoid on-street congestion. A high standard of landscape treatment is required which should generally contain a mixture of tree and shrub planting, including where appropriate, semi mature trees and small copses. Wherever possible, and certainly in relation to large scale developments, a landscaping framework utilising native species should be provided reflecting the objectives of the Greenwood Community Forest Plan. Hard surfacing in good quality materials will be encouraged. Further advice is contained in Supplementary Planning Guidance No.1 published separately by the Council.

RESIDENTIAL CARAVANS AND MOBILE HOMES

- 5.84 Because caravans and mobile homes (excluding gypsy sites) can have significant effect on the environment and amenity of an area, their location should generally be treated in the same way as permanent buildings. In certain circumstances, particularly on agricultural holdings, it may be desirable to allow the temporary location of a residential caravan in order to test the need for a permanent dwelling. Proposals for the location of caravans and mobile homes in general will be considered within the context of policy HG5.

PUBLIC OPEN SPACE IN NEW RESIDENTIAL DEVELOPMENTS

POLICY HG6 RESIDENTIAL DEVELOPMENT WILL ONLY BE PERMITTED WHERE OPEN SPACE IS PROVIDED TO MEET THE FOLLOWING REQUIREMENTS:-

- a) **ON SITES OF TWO HECTARES AND ABOVE, A MINIMUM OF 10% OF THE GROSS HOUSING AREA WILL BE PROVIDED AS OPEN SPACE,**
- b) **ON SITES OF LESS THAN TWO HECTARES AND MORE THAN FIVE DWELLINGS THE AMOUNT OF OPEN SPACE REQUIRED WILL BE ASSESSED BY TAKING INTO ACCOUNT THE TYPE OF HOUSING PROPOSED AND THE EXTENT OF, AND ACCESSIBILITY OF THE SITE TO EXISTING OPEN SPACE IN THE LOCALITY.**

WHERE IT IS NOT APPROPRIATE TO PROVIDE OPEN SPACE WITHIN A SITE BOUNDARY, A PLANNING OBLIGATION WILL BE NEGOTIATED TO ALLOW A SUM TO BE PAID TOWARDS:

- i) **EXISTING OPEN SPACE PROVISION TO BE IMPROVED, OR**
- ii) **NEW OPEN SPACE TO BE PROVIDED ELSEWHERE, OR**
- iii) **COMMUNITY WOODLAND PLANTING OR APPROPRIATE NATURAL HABITAT CREATION SCHEMES TO BE UNDERTAKEN.**

- 5.85 The Authority places great value on the provision of public open space within new residential development, not only as a recreation amenity, but also as a contribution towards the quality of the environment. New residential developments should, where appropriate, contribute to open space provision either by the creation of additional areas or the improvement of existing facilities in the locality. The provision of new woodlands within residential development, which contribute towards the Community Forest and which form part of this open space provision, will be encouraged. Generally, the Authority will require an area of land not less than 10% of the

gross housing area to be laid out as open space and, where appropriate, equipped for public recreation. The area must be safe, well related to dwellings and be of a shape and gradient to facilitate maximum usage and ease of maintenance. On some developments including those with a gross area of less than two hectares, it may be inappropriate to require on site public open space where small unmanageable sites will result, where the development proposed is unlikely to generate the need for open space, or where such sites may be in close proximity to existing facilities where duplication would be unnecessary.

- 5.86 Where open space provision on a site is inappropriate, unnecessary or better provided elsewhere, the Authority may require the payment of a commuted sum to facilitate off-site provision. This could take the form of upgrading existing areas of the locality or providing new facilities close by, including Community Forest projects. The commuted sum will be calculated in accordance with the Authority's scale of charges, which will be regularly updated, and secured by means of a negotiated planning obligation.
- 5.87 It is recognised that small developments of less than 5 dwellings and certain types of new residential development, such as elderly sheltered accommodation and residential care facilities, have different functional and operational requirements. In such cases neither the provision of public open space nor the payment of a commuted sum will be required.

RESIDENTIAL EXTENSIONS

POLICY HG7 EXTENSIONS OR ALTERATIONS TO EXISTING RESIDENTIAL PROPERTIES WILL BE PERMITTED WHERE THEY WILL NOT ADVERSELY AFFECT:-

- a) **THE VISUAL AMENITY OF THE LOCALITY,**
- b) **THE RESIDENTIAL AMENITY OF NEIGHBOURING PROPERTIES, AND**
- c) **HIGHWAY SAFETY.**

- 5.88 Extending or altering a residential property can have an adverse impact on the visual amenity of a locality if it is poorly designed or constructed with inappropriate materials. This can affect both the property itself and the street scene, making the development unacceptable. In addition, residential extensions can adversely affect neighbouring properties by loss of privacy from overlooking or massing, and overshadowing due to the size, extent and position of the proposal. In such cases it is often possible to reduce, relocate or redesign an extension to make it more acceptable. The Authority must also be satisfied that a proposed extension will not adversely affect highway safety due to its proximity to a highway or its position in relation to visibility splays. In addition, on site car parking facilities must be safeguarded. Further advice is contained in Supplementary Planning Guidance No.2 published separately by the Council.

RESIDENTIAL CARE FACILITIES, HOUSES IN MULTIPLE OCCUPATION, BEDSITS, FLATS AND HOSTELS

POLICY HG8 DEVELOPMENT OF RESIDENTIAL CARE HOMES, HOUSES IN MULTIPLE OCCUPATION, BEDSITS, FLATS AND HOSTELS WILL BE PERMITTED WHERE:-

- a) **THE AMENITY OF NEIGHBOURING PROPERTIES IS PROTECTED,**
- b) **ITS DESIGN IS ACCEPTABLE IN TERMS OF APPEARANCE, SCALE AND SITING,**
- c) **IN THE CASE OF RESIDENTIAL CARE HOMES THE OUTLOOK FROM BEDROOMS AND COMMUNAL ROOMS IS ADEQUATE,**
- d) **ADEQUATE PRIVATE GARDEN IS PROVIDED,**
- e) **BOUNDARY TREATMENT PROVIDES AN ACCEPTABLE STANDARD OF PRIVACY AND VISUAL AMENITY,**
- f) **ACCESS FOR VEHICLES AND PEDESTRIANS INCLUDING DISABLED PEOPLE, IS SAFE AND CONVENIENT,**

- g) PARKING FACILITIES ARE PROVIDED IN ACCORDANCE WITH COUNCIL STANDARDS, AS OUTLINED IN APPENDIX 7, AND**
- h) LANDSCAPING COMPLEMENTS AND ENHANCES ITS APPEARANCE.**

5.89 Residential care homes include nursing homes, elderly persons homes and special care homes. These take the form of either new build or conversion, and extension of existing property. The conversion of existing residential units to provide houses in multiple occupation, bedsits, flats and hostels creates a much needed source of accommodation. In addition, a small number of such facilities result from new build. All proposals must ensure that the amenity of residents in the neighbourhood is protected and that undue disturbance or an adverse change in character of the locality will not arise. In cases where new built facilities are proposed or a conversion involves substantial alterations to an elevation, careful design which reflects the character of the property and the locality must be achieved. Depending on the type of accommodation proposed and its location, it will be appropriate to provide adequate private garden facilities together with on site parking provision, or communal open space areas. Further advice is contained in Supplementary Planning Guidance No.3, published separately by the Council.

GYPSY CARAVAN SITES AND SITES FOR TRAVELLING SHOW PEOPLE

POLICY HG9 OUTSIDE THE GREEN BELT, PROPOSALS FOR GYPSY CARAVAN SITES AND SITES FOR TRAVELLING SHOW PEOPLE WILL BE PERMITTED WHERE:-

- a) THE NEED FOR A SITE IS ESTABLISHED,**
- b) THE SITE IS REASONABLY ACCESSIBLE TO COMMUNITY SERVICES AND FACILITIES,**
- c) THE SITE IS LOCATED SO AS TO MINIMISE THE POTENTIAL FOR NOISE AND OTHER DISTURBANCE THAT MAY RESULT FROM THE USE OF THE SITE FOR BUSINESS ACTIVITIES,**
- d) THE SITE DOES NOT ADVERSELY AFFECT THE VISUAL AMENITIES OF THE AREA, AND**
- e) ADEQUATE LANDSCAPING MEASURES ARE INCLUDED.**

5.90 The statutory duty for Local Authorities to provide accommodation on caravan sites for gypsies residing in or resorting to an area was repealed in the Criminal Justice Act, 1994. However Circular 1/94, 'Gypsy Sites and Planning' and Circular 22/91 'Travelling Show People' indicate that it is necessary for local planning authorities to make adequate provision in Development Plans. Where particular sites are not identified, the Local Plan should set out clear and realistic criteria for suitable locations.

5.91 Structure Plan Review policy 4/4 sets out criteria for assessing proposals for gypsy sites, taking account of their locational requirements and their impact on the locality. Gypsy sites and sites for travelling show people can involve a number of mixed uses including residential, storage of equipment and industrial uses associated with the activities they undertake e.g. scrap metal dealing, car breaking etc. It is important therefore, that such sites are located where the impact of these mixed uses on the local amenity is minimised. In this respect location of sites in relation to existing residential areas will be carefully considered. All proposals will be expected to incorporate landscaping to protect visual amenity in the overall area.

5.92 There are currently no gypsy caravan sites in Ashfield although a well established site is located just south of Hucknall off Moor Road in Nottingham City. There is a small site for travelling show people at Pond Street near Kirkby-in-Ashfield town centre although this has been allocated for retail development under policy SH2 following a proposal by the site owners. A site for travelling show people is however located in Pinxton just outside the District boundary. Investigations have failed to identify suitable sites for travelling show people and gypsies.

5.93 In view of the above, policy HG9 shows that, dependent upon criteria relating to location and

impact, long stay or short stay sites will be acceptable where a need has been demonstrated. Should a need be established it is unlikely that such provision would be acceptable outside the Main Urban Areas or Named Settlements as this would be contrary to the overall strategy of the Plan. In particular sites will not be permitted in the Green Belt. It is also unlikely that a proposal would be acceptable on land identified for employment purposes. Due to the mixed residential/industrial nature of activities in sites for gypsies and travelling show people, particularly relating to traffic and noise, housing sites in policy HG1 would also be inappropriate for this use.

CHAPTER 6: TRANSPORTATION

INTRODUCTION

- 6.1 Responsibility for Transport lies with the Department for Transport (DfT), and with the County Council. The Secretary of State is responsible for the trunk road and motorway network and gives policy advice on other transport matters. The Highways Agency now provides the day to day management of the trunk road and motorway network on behalf of the DfT. The M1 motorway is the only trunk road within Ashfield. The County Council is the Highway Authority for the remainder of the road network, together with public transport and provisions for pedestrians, cyclists, horse riders and other transport users. From July 1999 the County Council and City Council as Local Transport Authorities are responsible for the preparation of Local Transport Plans which will be used as a basis for the planning of transport schemes over a 5 year period. These plans are subject to public consultation and must relate to Local Plans within their respective areas. Ashfield District Council undertakes specific highway maintenance responsibilities as part of an agency agreement with the County Council. The Council uses the County Council's 'Highway Design Guide' and parking standards determined jointly by the District Council and the County Council as Highway Authority when considering development proposals.
- 6.2 This chapter provides policies to cover the essential safeguarding of land for all transport purposes including road, light rail, pedestrian and cycling schemes. A policy is also included to cover negotiation for developments to contribute towards public transport infrastructure. The underlying strategy of the plan in relation to sustainability and the relationship between land use and accessibility is generally covered within other chapters covering the choice and allocation of new development sites.

CENTRAL GOVERNMENT ADVICE

- 6.3 Revised PPG13 'Transport' recognises that forecast levels of traffic growth, especially in urban areas, cannot be met in full, and that new road building or upgrading of existing highways will, in some cases, be environmentally unacceptable. PPG6 'Town Centres and Retail Developments' stresses the need to minimise dependence on motor cars and to ensure that developments are located so as to be accessible to all forms of transport, including public transport, pedestrians and cyclists. Development also needs to be located so as to minimise journeys, particularly by motor car. In this respect the development of out of town shopping and other facilities is discouraged in favour of developments concentrated within town centres. Equally, new housing developments must be accessible by public transport. This advice is reflected in the overall strategy of the Local Plan summarised in Chapter 2 and particularly with reference to sustainability. Guidance also requires Local Plans to elaborate on proposals for the primary route network and in particular to safeguard land required for planned County Council schemes expected within about ten years. Safeguarding of land for other transport routes, including light railways, is also required.
- 6.4 The Government has published a White Paper on the future of transport: 'A New Deal for Transport: Better for Everyone' (July '98) which sets the strategy for achieving a more integrated transport network. This involves a comprehensive review of all transport and land use related activities to ensure less reliance on the car, increased opportunities for alternative transport choice (including walking and cycling) and means to increase fuel economy and reduce air pollution. The White Paper recognises the role of the planning system in controlling land use to achieve developments which reduce the need to travel and improve accessibility to jobs, leisure and services. The benefits of creating safe town centres and traffic free areas are also recognised.

STRUCTURE PLAN REVIEW

- 6.5 In line with government objectives the Structure Plan Review recognises the need to provide good accessibility between houses, jobs and other facilities and in particular to ensure that public transport penetrates residential areas and that employment, commercial or other developments are well related to residential areas and are accessible by public transport. The

Structure Plan Review therefore makes provision for the strategic transport planning needs of the County and in this context protects land required for improvement to all transport infrastructure including rail and bus networks, park and ride sites and measures to improve traffic flows (policy 5/1). Provision for new transport infrastructure to improve accessibility, particularly between employment areas and public transport and the safeguarding of land required for the NET (light Rail) scheme to Hucknall are covered by policies 5/2 and 5/3. Policy 5/4 requires negotiation with developers of housing, employment and other significant developments to secure funding towards improvements to public transport arising from their developments.

- 6.6 Proposals to assist cyclists, pedestrians and people with limited mobility are covered by policy 5/5. Road related issues covering the identification of the road hierarchy, traffic management, HGV movements and safeguarded DETR and County Highway Schemes are covered by policies 5/6 - 5/10 inclusive.
- 6.7 To ensure the relationship between energy efficiency and land use planning, policy 10/4 requires Local Plans to give preference to developments which concentrate employment intensive uses and higher density housing in locations well served by public transport.
- 6.8 The Hucknall area falls within the South Nottinghamshire Sub-Area where the principal concerns include increasing traffic levels causing problems of congestion, pollution etc. The remainder of Ashfield, falling within West Nottinghamshire, is characterised by the need to overcome the poor accessibility that sometimes exists between job need and existing and potential employment sites. Whilst accessibility to the Strategic Road Network including the M1 and A38 for most of this area is good, areas to the north of Sutton-in-Ashfield, and to the west of the M1 Motorway have poor communications, and limited access to public transport to provide access to jobs and town centres.

TRANSPORT OBJECTIVES

- 6.9
- a) To improve accessibility to town centres in ways which enhance economic opportunity and encourage sustainable development in these centres.
 - b) To restrict traffic growth and encourage modal change away from the private car, particularly to town centres and other major traffic generators.
 - c) To open up land for employment development, and to improve accessibility between areas of job need and employment and training opportunities.
 - d) To ensure that all major new development is well connected to the public transport system.
 - e) To encourage the provision of safe walking and cycling facilities for short journeys, including travel to schools.
 - f) To provide for safe and convenient access for disadvantaged groups, particularly disabled people.

PUBLIC TRANSPORT

- 6.10 The significant and continuing growth of traffic, particularly private cars, will continue to exert pressure on the road system. Improvements to the existing road network cannot cater totally for the expected increase in usage and therefore the provision of a good public transport network will be a significant element in dealing with congestion and in particular in maintaining the roles of town and district centres and facilitating access to services for non-car owners, particularly those living in rural areas.
- 6.11 The District Council, whilst not responsible for public transport, can through its development control and Local Plan policies ensure that developments relate to existing and proposed public transport facilities and ensure that designs allow for the satisfactory operation of public transport services.
- 6.12 As part of its integrated approach to the provision of transport facilities, the County Council is committed to the improvement of both the bus and the rail network in the County. In Ashfield this has involved the opening of the Robin Hood Railway Line passenger rail service from

Nottingham to Worksop, including Stations at Hucknall, Newstead, Kirkby-in-Ashfield and Sutton Parkway which serve the Ashfield area. The Stations provide important public transport nodes to which bus routes, cycle routes and park and ride can be channelled to improve the integration of transport services. The improvement of the bus network involves the development of 'Bus Quality Partnerships' to upgrade the quality and reliability of bus services, the provision of bus lanes and priority measures and better information for passengers. The intention is to offer journeys comparable with private transport and improve the image of bus travel. The strategy for choice of development sites places a high priority on accessibility to all forms of public transport.

NOTTINGHAM EXPRESS TRANSIT

POLICY TR1 THE FOLLOWING LAND REQUIRED FOR THE NOTTINGHAM EXPRESS TRANSIT SYSTEM WILL BE SAFEGUARDED FROM DEVELOPMENT:-

Hucknall

Ha THE ROUTE OF THE RAPID TRANSIT SYSTEM FROM THE BOUNDARY WITH NOTTINGHAM CITY TO STATION ROAD.

Hb OFF BATHS LANE, FOR ADDITIONAL CAR PARKING.

Hc AN EXTENSION OF THE ROUTE OF THE RAPID TRANSPORT SYSTEM FROM HUCKNALL STATION TO THE BOUNDARY WITH GEDLING BOROUGH.

- 6.13 Nottingham City Council and the Nottinghamshire County Council are jointly promoting the development of a light rail system to serve the public transport needs of Greater Nottingham as part of the strategy to provide an integrated public transport system. The scheme received Royal Assent in July 1994 by the publication of the Greater Nottingham Light Rapid Transit Act 1994. Route 1 of the system terminates at Hucknall and will run in parallel with the Robin Hood Line for that part of the route proposed within Ashfield. Hucknall Station will provide an opportunity for passenger interchange facilities and will be an important park and ride site requiring car parking for an estimated 460 cars.
- 6.14 Funding for the project was secured in December 1998 and the route, which is to be constructed and operated by a private development consortium, is expected to be complete by 2002. Land is required for safeguarding alongside the existing Robin Hood Line track. In addition land to the south and west of the existing station car park is safeguarded for car parking expansion to provide park and ride facilities. Planning permission was granted for this car park area in April 1999.
- 6.15 Proposals for new housing and employment development to the north of Hucknall are currently being considered as part of the Gedling Local Plan Review process. Whilst the outcome of this process is not currently finalised, a safeguarded route has been identified between Hucknall Station and the boundary with Gedling Borough to the north. This will allow for a potential extension of the NET system, should this be required in the future, to widen transport choices in this area.

CYCLING

- 6.16 Cycling is an environmentally friendly, economical and efficient means of transport, providing an alternative to reliance on private cars, particularly on short or local journeys where car use may be unnecessary. The Council's strategy of concentrating development to Main Urban Areas and Named Settlements will assist in locating new developments within easy reach of potential cycle users and encourage the use of cycles between home, work, shopping centres and recreation facilities.
- 6.17 The Council will promote transport choice through the encouragement of cycling as an alternative means of travel to the private car. This includes positive measures to assist in the identification and implementation of new cycle routes with the aim of developing a comprehensive and effective cycleway network in the District. The Cycling Strategy and the

Local Transport Plan, prepared by the County Council, recognises that cycling provision should not be limited to the creation of dedicated routes and requires that new highway schemes should adopt cycle friendly designs. The District Council will also require that adequate provision where appropriate is made in new developments for the needs of cyclists.

CYCLING PROVISION IN NEW DEVELOPMENTS

POLICY TR2 DEVELOPMENT PROPOSALS TO WHICH CYCLISTS WOULD REASONABLY EXPECT TO HAVE ACCESS WILL BE PERMITTED WHERE PROVISION IS MADE FOR:-

- a) **SAFE AND CONVENIENT CYCLE ACCESS,**
- b) **LINKS WITH EXISTING OR PROPOSED CYCLE ROUTES WHERE APPROPRIATE.**
- c) **CYCLE PARKING FACILITIES IN ACCORDANCE WITH PROVISION IDENTIFIED IN APPENDIX 7**

- 6.18 In larger developments, likely to generate significant cycle traffic, provision should be made for safe and convenient cycle access as part of the highway/pedestrian layout within the scheme. Such developments might include public buildings such as schools, libraries, leisure centres and health centres, public transport interchanges and larger housing, employment and retail developments. Measures to make cycling safer in larger developments may include separation from other road traffic, shared pedestrian and cycle routes, priority measures (eg The Home Zones concept) and vehicle speed control. In larger housing and industrial estates, it may be appropriate to provide designated separate internal cycle routes. Where possible, suitable cycle links should be made between such developments and any part of the existing or proposed cycleway network. In appropriate circumstances, the Council may also require the provision of cycle parking facilities as part of a proposed development. Limited advice on cycle parking standards is included in Appendix 7. Secure and weatherproof cycle parking facilities will be encouraged where appropriate, particularly at shopping centres, major new workplaces and also at bus and rail stations to encourage 'bike and ride' practices. This will assist in encouraging people to commute all or part of the way to work by cycle and to cycle to shopping centres.

PEDESTRIANS AND PEOPLE WITH LIMITED MOBILITY

POLICY TR3 DEVELOPMENT TO WHICH THE PUBLIC WOULD REASONABLY EXPECT TO ENJOY ACCESS WILL ONLY BE PERMITTED WHERE SUITABLE PROVISION IS MADE IN THE DESIGN OF THE EXTERNAL ENVIRONMENT FOR SAFE AND CONVENIENT ACCESS BY PEDESTRIANS AND PEOPLE WITH LIMITED MOBILITY.

- 6.19 The creation of a satisfactory pedestrian environment, where the public can reasonably expect to enjoy access, is an essential part of the successful development of new housing, shopping, community facilities and, in some cases, employment areas. This is particularly important for those with mobility impairments, including those with prams as well as people with physical disabilities. In such areas there is a need to consider the provision of special facilities such as disabled parking spaces, access ramps, handrails, flush kerbs, tactile surfaces and signs for the visually impaired. The layout of a site should also ensure the physical separation, where possible, of pedestrian and vehicle circulation areas. Where physical separation is not possible, measures will need to be included to control vehicle speeds to suitable levels (eg The Home Zones concept). The design and location of street furniture, landscaped areas and tree planting, and the general layout of facilities in relation to car parking areas, public transport facilities and taxi ranks will also be important considerations. This policy will only apply to the external environment in general where public access is usually available. It will not apply to the internal design or layout of buildings where existing controls under the Building Regulations include specific provision for pedestrian and disabled access.

PEDESTRIAN PRIORITY SCHEMES

POLICY TR4 A PEDESTRIAN PRIORITY SCHEME WILL BE IMPLEMENTED FOR THE FOLLOWING AREA:-

Hucknall

Ha HIGH STREET FROM STATION ROAD TO THE MARKET PLACE AND BAKER STREET FROM ITS JUNCTION WITH HIGH STREET TO OGLE STREET.

- 6.20 The growth of traffic in towns introduces noise, fumes, vibration and road safety problems making life unpleasant for pedestrians. Pavement widths in many cases can be inadequate to cater for the large number of pedestrians, particularly in the main shopping areas and in some cases this may be a deterrent to their use. The removal of non-essential traffic from the main shopping areas is therefore an important aspect of transport planning and environmental improvement. Pedestrian schemes have been implemented at Sutton-in-Ashfield and Kirkby-in-Ashfield and a Scheme for Hucknall is now considered a high priority.
- 6.21 The Hucknall Inner Relief Road proposals provide an essential alternative north-south route for traffic in the town centre, between Station Road and Baker Street to allow the removal of traffic from the High Street and Market Place and generally to upgrade the environment for the benefit of pedestrians. The nature of existing servicing arrangements for shops on the High Street and the need to ensure access to Watnall Road may require some traffic to remain on the High Street and it is unlikely that the section from Watnall Road to Station Road could be fully pedestrianised. The general intention of any scheme however would be to provide for pedestrian priority over traffic movement wherever possible. Consequently, it is possible to consider the whole length of the High Street, from its junction with Station Road, through to the Market Place/Baker Street, as a potential pedestrian priority area. Detailed design has not been undertaken at present. The above policy indicates the total area which is likely to be included in any such scheme. The County Council will be encouraged to consider the potential for allowing cycle access through the proposed pedestrianised area. Full public consultation will be undertaken to determine details of the scheme including the requirement to ensure suitable service access to existing premises and the needs of public transport operators.
- 6.22 This policy accords with Structure Plan Review Policy 13/4 which identifies Hucknall to be developed as a major District Centre in terms of retailing and other town centre functions. The pedestrianisation of the town centre is regarded as an essential element of this process. This Authority regards the pedestrianisation of the town centre as a high priority in order to meet the increasing pressures on the town which will arise from new development in the area.

COUNTY COUNCIL HIGHWAY SCHEMES

POLICY TR5 LAND REQUIRED FOR THE FOLLOWING COUNTY COUNCIL HIGHWAY SCHEMES WILL BE SAFEGUARDED FROM DEVELOPMENT:-

Hucknall

Ha INNER RELIEF ROAD.

Kirkby-in-Ashfield

Ka A611 JUNCTION WITH ANNESLEY CUTTING.

Kb A611/B6021 SHOULDER OF MUTTON HILL JUNCTION IMPROVEMENT.

Kd B6021 LOWMOOR ROAD IMPROVEMENT - SOUTHWELL LANE TO ODDICROFT LANE.

Named Settlements**Bestwood**

Na MOOR ROAD, BESTWOOD.

Rural Area

Ra HAMILTON ROAD IMPROVEMENT (COXMOOR ROAD TO OAKHAM BUSINESS PARK).

Rb MANSFIELD ASHFIELD REGENERATION ROUTE (PHASES 2 & 3).

- 6.23 Until July 1999 the Transport Policies and Programme (TPP) was prepared by the County Council on an annual basis to outline the provision of transport schemes within the County and to indicate planned schemes and costs in future years. From 1995 these were prepared on a 'package' basis aimed separately at Greater Nottingham and West Nottinghamshire and focussed on all aspects of transport needs. The above scheme list is derived from the last submission (1999/2000) and also from the County Council's own list in Structure Plan policy 5/10 and from smaller scheme lists.
- 6.24 From July 1999 the TPP has been replaced by Local Transport Plans (LTP) which set out more detailed programmes of measures relating to all transport issues. Two LTP's affect the Ashfield area. Hucknall is covered by the Greater Nottingham LTP prepared jointly by the City and County Councils and the rest of the District is covered by the North Nottinghamshire LTP prepared by the County Council. Both plans were produced in provisional form in July 1999 and full plans were submitted in July 2000. The plans will set out an integrated strategy for transport and details supporting transport policies and programmes of schemes to cover the five year period 2001 – 2006 with requirement to provide a 10 year vision for transport in the area. They are designed to deliver a range of objectives for promoting sustainable and integrated transport including integration with land use planning, policies for education, health and the environment. They have been subject to wide ranging consultation and include supporting statements from relevant District Councils, and received Governmental approval in December 2000. The LTP is now the chief means of confirming that named schemes in TR5 are expected to proceed during the plan period.
- 6.25 The Hucknall Inner Relief Road was identified in the Structure Plan Review as safeguarded for construction within the plan period to 2011. The LTP for Greater Nottingham will review both the timing and role of the scheme. Funding for this scheme is currently not available and it will be expected that contributions from developments in Hucknall, in particular the retail and commercial developments at the former Hucknall Colliery, will be required in accordance with policy TR6 if it is to be constructed in the short to medium term.
- 6.26 It is important to consider the pedestrian scheme as set out in paragraphs 6.19, 6.20 and Policy TR4 and the Hucknall Inner Relief Road as just two elements of a more comprehensive integrated package of measures required to improve accessibility in and around Hucknall town centre. The panel report of the EIP of the Nottinghamshire Structure Plan recognised that while the road proposal may not be of strategic importance itself, it 'would further the strategic aim of enhancing the status and function of Hucknall as a district centre.' However, in the light of the recent Transport White Paper and guidance on Local Transport Plans, it is now timely to review the strategic role of the current road proposal by way of a multi-modal study to identify a range of transport measures to meet the objectives as set out in paragraph 6.9. The Study could identify a Mobility Management Action Area around the town centre, including the railway station and proposed NET terminus. The results of the study could then form the basis for a fully costed programme of measures for inclusion in the full Local Transport Plan to be submitted in July 2000 for the five year period 2001 to 2006.
- 6.27 In the Kirkby-in-Ashfield area three schemes require land to be safeguarded for construction within the Structure Plan period to 2011. Shoulder of Mutton Hill (TR5Kb) is a junction

improvement involving signal controls programmed for 2002/3 although this may be required earlier as part of any development of Lindleys Lane (see Appendix 5 Housing site brief H6). Lowmoor Road (TR5Kd) is a localised widening scheme with a medium term priority. Part of the Lowmoor Road improvement has been completed with the introduction of two mini roundabouts at the Southwell Lane and Lowmoor Road Industrial Estate junctions. At Annesley Cutting (TR5Ka) a junction improvement is required, to give buses priority, involving the introduction of traffic signals. This scheme is programmed for 2003/4

- 6.28 The County Council has resolved to improve east-west road links to increase accessibility within the County to the A1 and M1 to assist with regeneration following coalfield closures and to improve access across Mansfield. Part of this work involves the construction of a Mansfield-Ashfield Regeneration Route from Rainworth around the southern and western sides of Mansfield to the Pleasley By-Pass (TR5Rb). This scheme can be divided into three phases, A617 Rainworth Bypass to A60 (within Mansfield District), A60 to A38 King's Mill (within Ashfield District) and the final section A6075 Beck Lane to Pleasley (part in Ashfield). The alignment of the route has been established following an extensive public consultation exercise and the safeguarded line is shown on the Proposals Map. The County Council has included the scheme in the provisional LTP for North Nottinghamshire which has been provisionally accepted for funding support with a planned start for construction in 2001/2.
- 6.29 At Moor Road Bestwood (TR5 Na) a long term scheme (after 2005) of road widening and alignment improvements is proposed as a joint County Council/City Council scheme. The provisional LTP for North Nottinghamshire includes a scheme of widening and junction improvements on Hamilton Road from Coxmoor Road to Oakham Business Park (TR5 Ra) with construction planned in 2004/5. The County/City Council will carry out local consultation before proceeding with any scheme.
- 6.30 In addition to the schemes listed above, the County Council will promote other locally important schemes that may emerge from the development of the full LTP.

DEVELOPER CONTRIBUTIONS TO TRANSPORT IMPROVEMENTS

POLICY TR6 WHERE A DEVELOPMENT PLACES ADDITIONAL DEMANDS ON TRANSPORT INFRASTRUCTURE, PLANNING OBLIGATIONS WILL BE NEGOTIATED TO ALLOW A SUM TO BE PAID TOWARDS ANY OF THE IMPROVEMENTS LISTED BELOW:

Hucknall (South Notts. Sub-Area)

- a) **HUCKNALL INNER RELIEF ROAD.**
- b) **BROOMHILL FARM TO BY-PASS - BUS LANE.**
- c) **HUCKNALL BY-PASS SOUTHERN ROUNDABOUT BUS/CYCLE PRIORITY MEASURES.**
- d) **OTHER SCHEMES WITHIN THE HUCKNALL – NOTTINGHAM TRANSPORT CORRIDOR.**

Sites Across the Whole District

- e) **IMPROVEMENTS TO PUBLIC TRANSPORT INFRASTRUCTURE INCLUDING:**
 - i) **BUS PRIORITY MEASURES.**
 - ii) **BUS STOP FACILITIES.**
 - iii) **RAIL FACILITIES.**
 - iv) **ASSOCIATED HIGHWAY INFRASTRUCTURE TO SUPPORT PUBLIC TRANSPORT MODES.**
- f) **IMPROVEMENTS TO THE CYCLING NETWORK.**
- g) **IMPROVEMENTS TO PEDESTRIAN FACILITIES.**
- h) **PARK AND RIDE SITES.**

**SUCH PLANNING OBLIGATIONS WILL BE NEGOTIATED WHERE A DEVELOPMENT EXCEEDS THE FOLLOWING MINIMUM THRESHOLDS: 0.4Ha. OR 50 BEDROOMS, WHICHEVER IS THE LOWER, FOR RESIDENTIAL DEVELOPMENT.
1,000 M² GROSS FLOORSPACE FOR RETAIL DEVELOPMENT.
2,500 M² GROSS FLOORSPACE FOR OFFICE USES AND.
5,000 M² GROSS FLOORSPACE FOR EMPLOYMENT DEVELOPMENT.
FOR COMMERCIAL, LEISURE, TOURISM, HEALTH AND EDUCATION USES, OBLIGATIONS WILL BE DETERMINED LOCALLY WHERE TRANSPORT IMPACT IS SIGNIFICANT.**

- 6.31 This policy accords with and extends the concept of policy 5/4 of the Structure Plan Review aimed at securing financial contributions from developments towards public transport improvements. It will apply equally over the whole District although specific reference is made to some detailed schemes in the Hucknall area. The Hucknall to Nottingham transport corridor is an essential element of the strategy of the Structure Plan Review which in turn assisted in determining the levels of new development allocated to the Hucknall area. It is widely recognised that the growth in car ownership and use is leading to serious congestion and reduction in environmental quality. The White Paper 'A New Deal for Transport' aims for an integrated transport policy with more sustainable transport choice. This will include the need for future investment plans to introduce public-private partnerships to secure sufficient finance for local transport schemes where appropriate. The proposed Mobility Management study described in paragraph 6.26 above will provide the opportunity to establish a funding and implementation strategy for transport improvements in the Hucknall town centre area.
- 6.32 Circular 1/97 'Planning Obligations' sets out Government Policy relating to developer contributions identifies five key tests, which state that a planning obligation should be:
- a) necessary
 - b) relevant to planning
 - c) directly related to the proposed development
 - d) fairly and reasonably related in scale and kind to the proposed development
 - e) reasonable in all other respects
- 6.33 It is considered that all developments subject to Policy TR6 will in some way impact on traffic flows along the Hucknall-Nottingham transport corridor. Hence it is considered logical within the scope of the advice in circular 1/97 to expect developments to contribute in some way to essential improvements within the corridor, including parts of the corridor outside of Ashfield within the City of Nottingham. Supplementary Planning Guidance is currently being prepared by the County and City Councils as strategic planning authorities in consultation with the district councils, GOEM (DETR) and others as a basis for the negotiations of sums to be paid. The levels of any contributions will of course be subject to negotiation with individual developers and will need to take account of the size of the site, the likely impact of such development on road traffic and other essential infrastructure cost (both on and off site) associated with the development, together with other specific contributions that developers may agree towards such matters as open space provision, affordable housing provisions or other community facilities. Any contributions will be expected to be used on schemes within five years of receipt.
- 6.34 The schemes listed within policy TR6 above are all considered to be essential to the improvement of the Hucknall to Nottingham Public Transport Corridor. The Hucknall Inner Relief Road will allow improved access from the north of the town to the Robin Hood Line Station and proposed NET terminus while at the same time allowing for substantial improvements to pedestrian accessibility to the town centre. The site at Hucknall Colliery for retail and other Town centre uses will be expected to make a substantial contribution to this particular scheme. Bus priority measures along the whole corridor will include the provision of bus priority lanes and associated junction improvements to ensure faster access to Nottingham City Centre and improvements to bus stops including shelters and improved information about bus services. Safe routes for cyclists, particularly along the main transport corridor route will encourage greater use of cycles. Improvements to pedestrian facilities (in addition to the potential for pedestrianisation of the town centre) will include safer routes for pedestrians at

major junctions and for improved accessibility to bus stops, NET and Robin Hood Line Stations. The provision of park and ride sites will encourage greater use of the public transport network and assist in reducing congestion on roads into Nottingham City Centre. Within the remainder of the District, contributions will also be sought towards improving public transport, cycling and pedestrian facilities.

CAR PARKING

- 6.35 The provision of car parking for shoppers and visitors included in retail and leisure developments within town centres is important in maintaining the attraction and prosperity of such areas. However an increasing reliance on the car and availability of substantial car parking, particularly workplace parking, is seen as an obstacle to the use and development of alternative transport facilities.
- 6.36 The provision of car parking space within new development has, to date, been based on minimum levels, leading in many cases to an over provision of car parking. PPG13 states that the availability of car parking has a major influence on choice of means of transport and therefore that a reduction in private non residential car parking spaces can substantially reduce traffic flows, particularly at peak times. PPG3 also indicates that a restraint based approach should be taken in relation to parking provision. In considering proposals for new development within the District, the Council will apply maximum parking levels. Appendix 7 of the Plan contains the adopted parking standards of the District Council. This comprises of Appendix 2 from the Regional Planning Guidance (RPG), which reflects PPG 3 and PPG 13, and, 'Interim Parking Guidance', which was previously prepared jointly by the District Council and County Council and predates the RPG. When considering parking provision both documents should be read together, although the RPG derived guidance will take precedence over the 'Interim Guidance' where the two conflict. The Interim Parking Guidance is however, subject to review by the County Council in light of PPG3, PPG13 and the Regional Planning Guidance for the East Midlands. Once completed, this will be adopted by the Council for development control purposes.
- 6.37 Within town centres and in other locations well served by public transport, it is recognised that developers should be expected to reduce parking associated with new development below the expressed maximum levels
- 6.38 In some circumstances improvements to the overall provision of town centre car parks may be more appropriate or it may be more appropriate to improve public transport or access for those walking or cycling to the town centre. In such instances the Council will consider allowing the development subject to an agreed financial contribution to be used wholly towards publicly provided car parking facilities in the area or improvements in public transport or access for those walking or cycling to the centre.

CHAPTER 7: SHOPPING

INTRODUCTION

- 7.1 The traditional role of the town centre as a focus for the main retailing activities of an area remains. However, over recent years a number of changes have taken place in retail developments which has affected the pattern of shopping provision. These include a tendency towards larger foodstores providing for one-stop shopping trips on a reduced frequency, the development of retail warehouses (either individually or in parks) accommodating DIY goods, electrical appliances, carpets, furniture and other non-food goods, and the development of large regional shopping centres providing a full range of shopping and leisure facilities.
- 7.2 Whilst changes in retailing patterns have been recognised in planning policy guidance and the Nottinghamshire Structure Plan Review, planning policy at both the national and strategic level is to maintain and enhance the role of existing town centres and local shopping provision. This policy is reflected at a more detailed level in this Local Plan.

CENTRAL GOVERNMENT ADVICE

- 7.3 PPG6 'Town Centres and Retail Developments' sets out the Government's advice on retail development. The Government's objectives are in line with their overall strategy of sustainable development with an emphasis on accessibility for all consumers by means of a choice of transport other than the car. To achieve this strategy the main objective is to sustain and enhance the vitality and viability of town centres by making them the preferred choice for new retail, employment, leisure and other key town centre uses.
- 7.4 PPG6 introduced the concept of the 'sequential' approach to identifying preferred locations for retail development with preference being given to sites within the town centre rather than on the edge or out-of-centre following the identification of need for new retail development. Advice is also provided on encouraging diversity of uses in town centres, promoting mixed use developments, monitoring change and improving accessibility. In planning for new retail development, advice is also given on the main factors to be considered in dealing with different types and levels of retail proposal.

STRUCTURE PLAN REVIEW

- 7.5 The Nottinghamshire Structure Plan Review recognises the importance of sustaining the role and function of existing shopping centres and Structure Plan Review policy 6/1 identifies the centres of Hucknall, Kirkby-in-Ashfield and Sutton-in-Ashfield as District Centres whose role should be sustained and enhanced with particular provision for appropriate expansion of retail and other facilities. Hucknall is also identified in policy 13/4 as a 'Major District Centre' to be developed in terms of retailing and other, town centre functions. In recognising that some retail activities cannot always be catered for within town centres policy 6/2 provides criteria for considering major edge of centre and out-of-centre retail facilities. Policies 6/4 and 6/5 provide guidance for the provision of local shopping facilities in smaller settlements and rural areas. Policy 6/6 identifies the need to improve existing shopping centres by improvements to public transport systems, providing adequate car parking and servicing and by enhancement to the environment particularly for pedestrians and cyclists.

SHOPPING OBJECTIVES

- 7.6
- a) To facilitate the development of a range of shopping facilities to meet the needs of the community.
 - b) To encourage new shopping, other appropriate developments and environmental improvements within town centres to promote quality and attractiveness in order to sustain and enhance their vitality and viability.
 - c) To ensure that car-borne shoppers, those who rely on public transport, cyclists and pedestrians have proper access to shopping and other town centre facilities.
 - d) To protect and enhance the role of local shopping centres.
 - e) To minimise car borne travel and maximise the use of public transport, cycling and walking wherever possible, in order to reduce pollution.

DISTRICT SHOPPING CENTRES

POLICY SH1 IN THE DISTRICT SHOPPING CENTRES OF HUCKNALL, KIRKBY IN ASHFIELD AND SUTTON IN ASHFIELD, AS DEFINED ON THE PROPOSALS MAP THE FOLLOWING DEVELOPMENTS WILL BE PERMITTED

- a) **DEVELOPMENT/REDEVELOPMENT FOR SHOPPING PURPOSES,**
- b) **COMMERCIAL DEVELOPMENTS APPROPRIATE TO A TOWN CENTRE,**
- c) **RESIDENTIAL AND EMPLOYMENT DEVELOPMENT,**
- d) **TRAFFIC MANAGEMENT/SERVICING SCHEMES,**
- e) **ENVIRONMENTAL IMPROVEMENT SCHEMES,**
- f) **PARKING FACILITIES PROVIDED IN ACCORDANCE WITH THE COUNCIL'S STANDARDS, AS OUTLINED IN APPENDIX 7,**
- g) **MEASURES TO IMPROVE ACCESSIBILITY BY PUBLIC TRANSPORT, AND**
- h) **IMPROVEMENT OF FACILITIES FOR CYCLISTS, PEDESTRIANS AND THE DISABLED.**

7.7 Within Ashfield the three towns of Hucknall, Kirkby-in-Ashfield and Sutton-in-Ashfield have traditionally provided for the main local shopping needs of the District. This Local Plan Review aims to maintain that position by recognising that additional developments within these District Centres will be needed in the future and allocating sites accordingly. This accords with the overall strategy of the Plan to encourage development within the Main Urban Areas and acknowledges the Structure Plan Review strategy to sustain and enhance the three towns as District Centres. The Proposals Map identifies District Shopping Centre boundaries within which retail development will be encouraged. Policy SH1 indicates the main uses which are considered appropriate in these centres and which would assist in diversity of use as an important contribution to vitality and viability. Commercial developments include both offices and leisure activities. The re-use of vacant space above shops can contribute to the overall vitality of a centre, in particular residential uses. Uses which can assist in increasing the diversity of activities in the District Centres throughout the day and into the evening will also assist in enhancing their vitality and viability.

Hucknall

7.8 Hucknall is a District Shopping Centre serving the needs of the Hucknall area generally. The principal food shops are provided within the centre by Sainsbury and Kwik Save, and by the Aldi and Iceland Frozen Food stores to the south, but on the edge of the town centre, on part of the former Hucknall Colliery site. Most of the shops are confined to Baker Street, the Market Place and High Street, with some limited provision on Annesley Road and Watnall Road. A weekly market is held in the Market Place.

7.9 With the exception of a small mall off High Street no parts of the town centre benefit from pedestrianisation, and policy TR4Ha has already covered opportunities available. Land for new development within the traditional centre is limited. For this reason the defined District Centre of Hucknall recognises development opportunities to the south-east of the town where sites are well located in relation to the proposed route of the Inner Relief Road and to the Robin Hood Line/NET Station and associated car parking. It is important that land for development is available in, or close to, the existing centre to avoid pressures that may otherwise occur for any out-of-centre retail development. Major new retail developments on sites within the District Centre will be expected to make significant contributions towards the cost of the Inner Relief Road and pedestrianisation proposals for the High Street.

Kirkby-in-Ashfield

7.10 Kirkby-in-Ashfield is a relatively small District Centre with approximately 100 retail units serving the local area. Two stores, the Co-op and Kwik Save, provide the main food outlets in the town.

The remaining shops are relatively small, but provide a range of convenience and comparison goods. The shops are all located within easy walking distance of the centre at Station Street, Kingsway and within the Ashfield Precinct off Lowmoor Road. Public car parking exists close to the shops. The Ashfield Precinct is a pedestrianised area, and has recently been refurbished. A pedestrianisation scheme to remove through traffic from Lowmoor Road and to relocate the market onto the pedestrianised area and within the Ashfield Precinct was completed in March 2000. This scheme is designed to concentrate retail activity within the area of Station Street, Lowmoor Road and the Ashfield Precinct to assist in strengthening the attractiveness of the District Centre. As a result the defined centre is relatively tightly drawn. A retail development opportunity exists across the northern part of the District Shopping Centre. The Council will seek to co-ordinate matters such as parking and access by way of a development brief.

Sutton-in-Ashfield

- 7.11 Sutton-in-Ashfield is the largest of the three towns in the District and provides a wide range of shopping for both convenience and comparison goods. It has a larger catchment population than Kirkby-in-Ashfield or Hucknall and attracts trade from a wider area due to the larger range of shops. The central shopping area falls into two distinct areas divided by the pedestrianised Portland Square. To the south side is the Idlewells Centre and the pedestrianised areas of Low Street, Brook Street and the Market Place. To the north side is Outram Street to Northern Bridge and the Asda complex containing Iceland and McDonalds. Two markets operate within the town including an open market, at the Market Place and a covered market hall at the Idlewells Centre.
- 7.12 The town now has a virtually vehicular traffic-free shopping environment in much of the centre, furthering the Council's objective to maintain and consolidate the town as a significant District Shopping Centre. However, within the centre limited scope exists for new development without involving the redevelopment of existing buildings or loss of existing car parking areas. One site (SH2 Sa), to the north side of Outram Street adjacent to Northern Bridge, does provide an opportunity for new development and is incorporated into the defined District Centre area. The limits of the District centre at its southern end have been extended to recognise the importance of High Pavement and Station Road as potential areas for redevelopment, including a retail allocation (SH2 Sb).

Town Centre Management:

- 7.13 PPG6 refers to the concept of Town Centre Management as a means to co-ordinate the operations of a town centre in relation to such matters as the promotion of activities, security, car parking, environmental improvements, street cleansing, repair etc. This can be achieved through a partnership between the public and private sectors and assist in strengthening and improving the quality of town centres in a co-ordinated way to help compete with other centres and in particular out-of-town developments. The shopping objectives in paragraph 7.6 and policy SH1 provide the opportunities for any Town Centre Management initiative to be considered. The District Council is of the opinion that the appointment of any Town Centre Manager is best led by private sector businesses in each town. The Council has indicated its willingness to help fund the cost of such positions and in this respect the Sutton Town Centre Group is currently advancing an initiative.

THE NEED FOR NEW RETAIL DEVELOPMENT

- 7.14 Planning Consultants, have advised the Council on the need for retail floorspace in Hucknall, Kirkby-in-Ashfield and Sutton-in-Ashfield based on planned residential development requirements to 2011 and population projections from the Structure Plan Review. This work was originally undertaken in March 1998 but has subsequently been updated in March 2000 to take account of revised retail floorspace surveys and the latest projections of population and per capita retail expenditure. Details are contained in the revised Technical Paper 4 'Retail Floorspace Guidelines.
- 7.15 A retail floorspace potential model has been applied to the District which provides a set of base floorspace guidelines assuming that present shopping behaviour continues in future. Some of

the capacity for identified new development could be taken up within existing vacancies in District Centres, although it is recognised that some vacant units may be too small or at inappropriate locations to provide for substantial future needs. Table 7.1 below sets out the potential for new floorspace requirements which has assumed the average figures referred to in Technical Paper No.4 and is influenced by the potential for new population and housing arising within Gedling Borough but closely physically related to the Ashfield area. The figures also take account of reductions in floorspace requirements likely to arise from the impact of competing developments within the catchment areas with planning permission at the time of the study.

Area	Convenience Goods (sq m net)	Durable Goods* (sq m net)
Hucknall	1100	4080
Kirkby-in-Ashfield	520	2660
Sutton-in-Ashfield	1330	8830
TOTAL	2950	15570

* Includes both comparison durable and bulky durable needs.

- 7.16 The above table represents a quantitative assessment of justifiable retail needs within the three District Centres during the plan period to 2011. Account will need to be taken of the 'health' of the existing centres (as referred to in fig.1 to PPG6) and the opportunities that exist for sustaining and enhancing the quality of centres by additional retail development, the possibility of reducing the amount of leakage of trade that currently takes place to centres outside of Ashfield and of the continuing competition between retailers both within and outside Ashfield. In determining the overall land requirements for new retail sites within the three District Centres account has been taken of the above projections, together with the need to ensure that sites present retail developers with opportunities to provide developments which are well related to the existing District Centres.

RETAIL DEVELOPMENT SITES

POLICY SH2 RETAIL DEVELOPMENT WILL BE PERMITTED FOR THE USES SPECIFIED ON THE SITES LISTED BELOW AS SHOWN IN THE PROPOSALS MAP:-

Hucknall		Hectares
Ha	LAND WITHIN THE FORMER HUCKNALL COLLIERY FRONTING STATION ROAD FOR CONVENIENCE OR DURABLE GOODS.	3.7
Sutton-in-Ashfield		
Sa	LAND ADJACENT TO NORTHERN BRIDGE, OUTRAM STREET, FOR CONVENIENCE OR DURABLE RETAIL OR OTHER COMMERCIAL PURPOSES.	1.3
Sb	LAND FRONTING HIGH PAVEMENT AND STATION ROAD FOR CONVENIENCE OR DURABLE GOODS.	2.3

- 7.17 The above sites all lie within those parts of the towns identified as District Shopping Centres under policy SH1 and considered appropriate for the developments specified and acceptable within the advice of PPG6 and Structure Plan Review strategies. Other development or redevelopment sites not specifically identified may arise within the defined District Centres during the plan period. Any development on non-identified sites will be considered within the context of the overall floorspace requirements identified in table 7.1

Hucknall

- 7.18 The former Hucknall Colliery site provides the only substantial undeveloped area within the District Shopping Centre capable of providing for the expanded needs of Hucknall during the plan period. It is well related to the existing shopping area and to the proposed Inner Relief Road. It also lies adjacent to the Robin Hood Line Station and the proposed NET terminus that will contain substantial additional parking provision for 'park and ride' users.
- 7.19 Redevelopment proposals for the former colliery site include the provision of a new north-south spine road from Baths Lane (off Station Road) through to Nottingham Road (adjacent to Aldi) which acts as a distributor road within the site and a convenient boundary between proposed uses. To the west side of this proposed road the site has a frontage to Station Road and is considered the most appropriate location for new retail development (SH2 Ha). The western part of the site is an extension of the retail allocation from that identified in the Adopted Local Plan since the two factory sites of Doff Portland and Cormans are expected to be available for redevelopment. This will provide a more effective site area to accommodate new development and is better related to the rest of the town centre. The form and location of such uses will need to take account of the proposed residential allocation (HG1Hk) to the south which now replaces a previous retail and employment allocation included in the adopted Ashfield Local Plan. Development of this site for retail purposes will require off site highway improvements to ensure safe access to Station Road. Retail and other commercial uses on this site will be expected to make a substantial contribution to the proposed Inner Relief Road and pedestrianisation in Hucknall.

Kirkby-in-Ashfield

- 7.20 The retail floorspace projections indicate a relatively low requirement for convenience goods floorspace in Kirkby that in part may be related to its current limited catchment area, and the relative attraction of nearby District Centres. Additional development proposals in the town centre may increase the potential catchment area and assist in the recovery of trade leakage to other centres. A retail development opportunity exists across the northern part of the District Shopping Centre, as shown on the proposals map, is considered appropriate to cater for the future retail needs of the town, in addition to those which can be catered for by the re-use of existing vacancies in the town. The Council will seek to co-ordinate matters such as parking and access by way of a development brief.

Sutton-in-Ashfield

- 7.21 The retail floorspace projections for Sutton-in-Ashfield indicate the need for some additional convenience floorspace and a substantial requirement for durable goods provision. Consequently two sites are specifically allocated for either food or non-food purposes. In addition, other opportunities may exist within the defined District Centre for redevelopment and the plan also proposes a site at Kings Mill Road East (SH10) with some potential for exceptional retail development.
- 7.22 A link road from Priestsic Road to Outram Street, constructed as part of the Portland Square pedestrian scheme runs alongside Asda. In view of this it is considered appropriate to allocate a site adjacent to the link road with a frontage to Outram Street for a free-standing development, (SH2Sa). Since this is a site adjacent to an existing large food store and close to other parking facilities, the site would be appropriate for either food or non-food uses. Other commercial uses, e.g. cinema, bowling alley, etc. would also be acceptable on this site.
- 7.23 Station Road lies to the south side of the town connecting the town centre to the A38. Directly to the south of the junction of Station Road with High Pavement lies a large site currently in use as a car sales and maintenance depot with an adjacent site to the south occupied by Sainsbury's Homebase and an Aldi foodstore. It is considered appropriate to allocate the car sales site for convenience goods purposes (SH2Sb) within the defined District Centre. There is an opportunity for the development of this site to be extended, within the defined District Centre, to cover the public house site at the junction of High Pavement together with part of the

adjacent mixed use area up to and including Hardwick Street and this is accordingly allocated as part of the larger site. Due to the mix of ownership it is possible that the whole site may not be completed in one phase, but development of any part will need to be designed in such a way to ensure that the whole site can be comprehensively developed to ensure it properly relates to the rest of the town centre. Any access to such development will need to consider the impact of traffic at the Station Road - High Pavement junction.

- 7.24 Within the defined District Centre, in addition to the potential of the mixed use area referred to in para. 7.23 above, the area bounded by Brook Street, Market Place, King Street and Victoria Street contains a number of vacant and underused properties that provide the opportunity for a further redevelopment site. This area is however in multiple ownership and site assembly may be complicated. In view of this and the fact that the two allocated sites are more likely to come forward for development no specific allocation is proposed. Any retail proposals which arise for this area during the plan period will be considered in accordance with policy SH1 above.
- 7.25 The site at Kings Mill (SH10) has been identified for a range of potential uses. Although this site does not lie within the defined District Centre it is regarded as being within a strategic location on the Public Transport Corridor, between Sutton-in-Ashfield, Mansfield and Kirkby-in-Ashfield. It is considered appropriate for exceptional non-food retail development for bulky goods which could not easily be accommodated on sites within the town centres. 'Exceptional' in this context refers to a single large scale, non-food user requiring substantial floorspace and car parking provision. This site is not intended for smaller retail uses or subdivision of units to lower floorspace users. Any development of this site for retail purposes will be considered in the context of policy SH3 below.

RETAILING OUTSIDE DISTRICT SHOPPING CENTRES

POLICY SH3 MAJOR RETAIL DEVELOPMENT OUTSIDE DISTRICT SHOPPING CENTRES WILL BE PERMITTED WHERE:-

- a) **THE SITE CAN BE DEMONSTRATED TO MEET THE REQUIREMENTS OF THE SEQUENTIAL APPROACH,**
- b) **THE NEED FOR SUCH DEVELOPMENT HAS BEEN ESTABLISHED,**
- c) **DEVELOPMENT WOULD NOT DIRECTLY, OR WHEN CONSIDERED TOGETHER WITH ANY OTHER COMMITTED SCHEMES LIKELY TO BE DEVELOPED, ADVERSELY AFFECT THE VITALITY AND VIABILITY OF ANY EXISTING NEARBY DISTRICT OR LOCAL SHOPPING CENTRES,**
- d) **IT WOULD BE ACCESSIBLE BY A CHOICE OF MEANS OF TRANSPORT,**
- e) **IT WOULD BE WELL RELATED TO THE MAIN ROAD NETWORK,**
- f) **IT WOULD NOT GIVE RISE TO UNACCEPTABLE VEHICULAR AND/OR PEDESTRIAN TRAFFIC CONDITIONS,**
- g) **PARKING PROVISION IS IN ACCORDANCE WITH COUNCIL STANDARDS AS OUTLINED IN APPENDIX 7 AND,**
- h) **IT WOULD NOT LEAD TO UNACCEPTABLE INCREASES IN JOURNEYS BY PRIVATE CAR.**

ON SITES CONSIDERED TO BE ACCEPTABLE UNDER THIS POLICY CONDITIONS MAY BE IMPOSED TO CONTROL THE SCALE OF DEVELOPMENT, MINIMUM UNIT SIZES AND THE RANGE AND TYPE OF GOODS TO BE SOLD

- 7.26 PPG6 and Structure Plan policy 6/2 address the issue of retailing outside of District Centres. This policy covers those types of retail developments in excess of 1000 sq. metres gross floorspace, which the Structure Plan regards as major retail development, and will be used to determine applications for both edge of centre and out of centre retail applications. The concept of the "sequential approach" as outlined in PPG6 will underlie all considerations for new retail development and developers will be required to demonstrate that no suitable sites

exist first within District Centres, then at the edge-of-centres and in out-of-centre locations last of all. The quantitative need for new retail development is dealt with in Table 7.1 and supporting paragraphs and further expanded upon in Technical Paper No. 4: Retail Floorspace Guidelines. The need to maintain District Shopping Centres is recognised in Policy SH1 and to this end development which threatens the vitality and viability of District or Local Centres both within Ashfield and elsewhere in nearby Districts will be resisted. It is however recognised that some modern forms of retailing, such as those involving non-food bulky goods, may be satisfactorily located outside of District Centres without detriment to their retailing function.

7.27 In considering proposals for out-of-centre retailing the Council will wish to be satisfied that suitable alternative sites do not exist within District Shopping Centres and in particular why allocated sites, or failing this other sites within easy walking distance (usually no more than 300m in the case of convenience shopping), from the centre are not appropriate. Where such sites are not available, and there is a recognised need for additional floorspace, retailing provision outside of District Centres should be sited where it is accessible by a choice of means of transport. Account will need to be taken of the location of such developments in relation to the road network and in particular this should minimise the number of private car journeys from potential users. Sites should also be readily accessible by public transport, cyclists and pedestrians. This will usually mean locating retail developments close to District Centres and concentrations of people where car use can be minimised. While it is necessary to provide sufficient car parking on new retail sites, this should not exceed the Council's agreed standards which are expressed in "maximum" terms. This is part of a clear strategy to encourage the use of alternative means of transport to such sites. Provision will need to include cycle parking. Such developments will be unacceptable in the Green Belt and Countryside and dealt with under policies EV1 and EV2. Where retail developments are permitted under this policy, any subsequent sub-division into smaller units to create shopping malls will generally be resisted and planning conditions will be imposed which prevent this. The creation of smaller units would be contrary to the purposes of accepting such developments, which is to provide facilities that cannot easily be provided within established District Shopping Centres. The control of the range and type of goods to be sold through conditions may be appropriate in some circumstances to ensure that developments do not expand beyond the type of retail use originally approved where this was a material consideration in the original proposal. Conditions may also be imposed which prevent the inclusion of post offices and pharmacies in new retail developments which would be likely to cause the loss of such facilities in local centres and rural settlements.

7.28 Retail developments have also often been attracted to land allocated for employment purposes generally intended as suitable for B1, B2 and B8 uses as defined in the Use Classes Order. Although retail development does contain an element of employment provision, it will generally be necessary to resist loss of employment land to retail uses. Reference to this is made in policies EM4 and EM5.

LOCAL SHOPPING CENTRES

POLICY SH4 RETAIL DEVELOPMENTS WILL BE PERMITTED WHICH ARE IN SCALE AND CHARACTER WITH THE AREAS LISTED BELOW AND AS SHOWN ON THE PROPOSALS MAP:-

Hucknall

**Ha ANNESLEY ROAD.
Hb WATNALL ROAD.**

Sutton-in-Ashfield

**Sa OUTRAM STREET.
Sb HUTHWAITE MARKET PLACE AREA.
Sc HIGH STREET, STANTON HILL.**

Named Settlements

Jacksdale

Na VILLAGE CENTRE.

- 7.29 Despite the general trends towards larger one-stop retail provision and the concentration of shopping within defined District Shopping Centres, the role of the local shopping area, either within smaller settlements or at the edge of existing District Centres, is important in meeting the needs of local communities and in particular those who are less mobile. Such areas also provide for retail outlets outside the main stream of national retail chains where lower rentals for premises and smaller units allow the operation of local businesses providing niche retail and specialist uses where the need for high street frontages is less critical. Within these centres other uses, such as local community facilities and small scale office uses, will be acceptable.
- 7.30 Six areas have been identified which can be regarded as Local Shopping Centres, which are either adjacent to defined District Centres or serving District communities. These are:-
- Annesley Road, Hucknall (SH4Ha) - approximately 50 shops extending from the north side of the town centre.
 - Watnall Road, Hucknall (SH4Hb) - approximately 35 shops extending along Watnall Road to the west of the town centre.
 - Outram Street, Sutton-in-Ashfield (SH4Sa) - approximately 90 shops providing a wide range of uses from Northern Bridge to Mansfield Road.
 - Huthwaite Market Place area (SH4Sb) - the centre contains about 31 shops of which one third are food shops. The Market Place provides an important focus and car parking area to serve the centre.
 - High Street, Stanton Hill (SH4Sc) - approximately 38 shops situated on High Street provide a range of outlets including a small Co-op Supermarket and a Kwik Save store. The Stanton Hill area has suffered through recent colliery closures but redevelopment of the Sutton Colliery site and the inclusion of local sites for new residential development should allow for some improvement to the shopping area.
 - Village Centre, Jacksdale (SH4Na) - a smaller centre of about 20 shops of which almost half are food shops, serving the village and surrounding area.

MINOR SHOPPING CENTRES AND SINGLE SHOPS

POLICY SH5 RETAIL DEVELOPMENT TO MEET LOCAL SHOPPING NEEDS WILL BE PERMITTED WHERE:-

- IT PRIMARILY INVOLVES THE SALE OF CONVENIENCE GOODS, AND**
- NET RETAIL FLOORSPACE IS UNDER 500 SQ. METRES.**

- 7.31 Small scale shopping provision, whether in the form of shopping parades, small groups of shops or individual shops, account for about 17% of the shops in the District, almost 40% of which are food outlets. Like Local Shopping Centres they provide for the day to day needs of communities and particularly the less mobile. New smaller housing developments rarely provide facilities for new shops, but larger housing developments may justify the provision of additional local shopping facilities. Elsewhere the demand for such provision is difficult to quantify since most local shops of this nature occur infrequently and comprise individual business decisions. However, the need for local shops is recognised, particularly those providing convenience goods suitable for day to day needs. Proposals for smaller shops, either as new development or more probably changes of use of existing buildings, will generally be favourably considered. This policy specifically limits the net retail floorspace of such developments to below 500 sq. metres to ensure that only local facilities are provided outside established District Shopping and Local Shopping Centres. Proposals will be subject to the necessary site consideration policies.

FACTORY SHOPS

POLICY SH6 THE DEVELOPMENT OF A FACTORY SHOP WITHIN THE CURTILAGE OF AN EXISTING FACTORY WILL BE PERMITTED PROVIDED THE PRODUCTS TO BE RETAILED ARE MANUFACTURED BY THAT COMPANY

- 7.32 Land and buildings allocated for employment purposes will, in most cases, be inappropriate for retail use since the provision of these sites is generally scarce in relation to the opportunities for retail development which should more properly be located within or adjacent to existing District Centres. Policies EM4 and EM5 and para 7.28 cover this aspect. However, one exception to retail activity on employment sites relates to the provision of factory shops where a small part of a building is used for selling goods manufactured either on the premises or elsewhere by the same company. There has been a growth in the number of factory shops in the District over recent years, particularly in the textile industries, selling products which are slightly imperfect or surplus stock. In most cases these uses do not compete with or generally affect the viability of existing shopping areas and, provided they are limited to selling goods manufactured by the company in question and can provide adequate car parking facilities, will generally be acceptable. In many cases, provided the use is small scale and ancillary to the main use of the building, planning permission may not be required. For clarification this policy does not apply to the new-build retail concept of factory outlet shopping malls which are regarded as new retail units and subject to the controls of policies SH1-SH8 inclusive.

FARM SHOPS

POLICY SH7 PROPOSALS FOR FARM SHOPS ASSOCIATED WITH ESTABLISHED AGRICULTURAL HOLDINGS WILL BE PERMITTED PROVIDED THEY:-

- a) **PRIMARILY SELL AGRICULTURAL GOODS PRODUCED LOCALLY,**
- b) **REPRESENT A NECESSARY ELEMENT OF FARM DIVERSIFICATION, AND**
- c) **DO NOT SERIOUSLY AFFECT THE VIABILITY OF NEARBY VILLAGE SHOPS**

- 7.33 Annex C13-C16 to PPG7, 'The Countryside - Environmental Quality and Economic and Social Development', explains the position concerning the need for planning permission for farm shops. It is normally assumed that if a farm shop is used only for the sale of unprocessed goods produced on that farm with a minimal quantity of other goods, that is a use which is ancillary to the use as a farm and does not require permission. Farm shops selling a significant amount of 'imported' produce is a separate use to the farm itself and is therefore subject to full planning control. In considering proposals for farm shops, which require permission, the Authority will wish to ensure that the shop represents a necessary element of farm diversification which cannot be undertaken elsewhere on sites more appropriate for retailing. The potential impact such a proposal will have on the viability of nearby village shops will also be a consideration in line with the advice of PPG6. Farm shops must also ensure they do not create unacceptable traffic or other environmental problems.

SITE CONSIDERATION POLICIES

COMMERCIAL/RETAIL DEVELOPMENT

POLICY SH8 COMMERCIAL/RETAIL DEVELOPMENT WILL BE PERMITTED WHERE:-

- a) **ITS DESIGN IS ACCEPTABLE IN TERMS OF APPEARANCE, SCALE AND SITING,**
- b) **SIGNAGE IS ACCEPTABLE IN TERMS OF SIZE, POSITION, MATERIALS AND ILLUMINATION,**

- c) **PARKING IS PROVIDED IN ACCORDANCE WITH COUNCIL STANDARDS, AS OUTLINED IN APPENDIX 7,**
- d) **ACCESS FOR VEHICLES, IS SAFE AND CONVENIENT,**
- e) **ACCESS FOR PEDESTRIANS, CYCLISTS AND PUBLIC TRANSPORT, WHERE APPROPRIATE, IS SAFE, CONVENIENT AND INTEGRATED WITH EXISTING PROVISION,**
- f) **LANDSCAPING COMPLEMENTS AND ENHANCES ITS APPEARANCE, AND**
- g) **SECURITY MEASURES DO NOT ADVERSELY AFFECT THE CHARACTER OR APPEARANCE OF THE AREA.**

7.34 Commercial/retail developments, whether new buildings or re-use of existing buildings, often involving alteration to a principal elevation, can have a significant impact on a street scene. Accordingly, the Authority will expect designs and the use of materials to reflect the character of the area and add value to the street scene. In particular, the erection of signage can significantly affect the appearance of the building upon which it is displayed. Whilst the majority of signs are acceptable, some, by reason of size, position, choice of materials and intensity of illumination, can have a severely detrimental effect on a building and the street scene. The Authority will resist signage that has such an effect. More detailed guidance on advertisements is contained in Supplementary Planning Guidance No.6 which is published separately by the Council.

7.35 Developers should provide adequate on-site car parking and servicing facilities unless suitable provision is available in the vicinity. Appendix 7 provides guidance on the standards for parking in general and indicates the circumstances in which standards may be reduced by agreement, for example, in town centres where overall existing provision is considered to be acceptable at the time of any application. There should also be a safe and proper access for customers which incorporates satisfactory provision for the disabled. On larger developments which contain substantial forecourts or customer parking facilities, landscaping schemes will be required, including appropriate tree planting to improve the setting and appearance of such developments. Landscaping will need to take account of the location and the potential problems of maintenance and vandalism.

7.36 Increasing levels of crime and vandalism have led to many businesses taking measures to improve security. A number of options are available, including video surveillance, alarm systems, alterations to the window design, the use of laminated glass, the provision of removable external grilles, internal shutters and external roller shutters of various designs. Whilst some of these measures have little or no impact on the appearance of a building, others, in particular the erection of external roller shutters, can have a significant impact both individually and collectively on the street scene. In considering proposals the Authority will wish to balance the security needs of a business against the need to maintain and enhance the character of an area. The existence of fully monitored CCTV cameras in town centre areas for example may reduce the need for roller shutters etc. Further advice on the provision of security measures is contained within Supplementary Planning Guidance No.7 which is published separately by the Council.

HOT FOOD SHOPS

POLICY SH9 DEVELOPMENT OF HOT FOOD SHOPS WILL BE PERMITTED PROVIDED THAT:

- a) **THERE WOULD BE NO ADVERSE EFFECT ON THE AMENITY OF NEIGHBOURING OCCUPIERS THROUGH NOISE, ODOURS OR LITTER, AND**
- b) **OPENING HOURS ARE RESTRICTED WHERE RESIDENTIAL AMENITY COULD OTHERWISE SUFFER.**

7.37 The introduction of hot food shops can have an adverse impact on the amenity of an area particularly where late opening hours affect local residents. Consideration will therefore be given to the need to restrict hours of opening where residential amenities could otherwise

suffer. In some locations, particularly in residential areas, hot food shops may be unacceptable or could only operate with limited hours of opening so as to protect the amenity of the locality. Other sites are less sensitive, such as town centres, where later opening hours or unrestricted opening times may be appropriate. Some hot food shops involving take-away facilities can give rise to litter and such proposals should incorporate adequate litter bin facilities in the locality. Odour from such uses can also cause nuisance to nearby properties and adequate extraction facilities will be required together with any measures considered necessary to reduce noise emission. Further detailed requirements and guidelines for hot food shops are contained in Supplementary Planning Guidance No.8 which is published separately by the Council.

SPECIAL DEVELOPMENT SITE: KINGS MILL ROAD EAST/MANSFIELD ROAD, SUTTON-IN-ASHFIELD

POLICY SH10 AT THE SPECIAL DEVELOPMENT SITE AT KINGS MILL ROAD EAST/MANSFIELD ROAD, AS SHOWN ON THE PROPOSALS MAP, DEVELOPMENT FOR THE FOLLOWING USES WILL BE PERMITTED:-

	Hectares
a) NON FOOD RETAIL FOR BULKY GOODS FOR A SINGLE USER WHERE SUITABLE ALTERNATIVES ARE NOT AVAILABLE	3.9
b) HOUSING	2.8
c) ROAD RELATED INCLUDING HOTEL	0.8
d) OPEN SPACE	1.2

THE ABOVE WILL BE SUBJECT TO:-

- i) RELOCATION OF THE EXISTING SOCIAL CLUB, PLAYING PITCHES AND CHANGING FACILITIES,
- ii) PROVISION OF 1.2 HECTARES OF OPEN SPACE ADJACENT TO THE WESTERN BOUNDARY OF THE SITE,
- iii) THE PROVISION OF A REPLACEMENT ALL WEATHER SURFACE ATHLETICS TRACK WITH ASSOCIATED FACILITIES.

DETAILED SITE REQUIREMENTS IN THE SUPPORTING TEXT AND SITE BRIEF IN APPENDIX 8 WILL BE NEGOTIATED AND SECURED, AS APPROPRIATE, BY PLANNING CONDITIONS OR PLANNING OBLIGATIONS

- 7.38 This large site is located within the urban area of Sutton-in-Ashfield and occupies a key location adjacent to the strategic highway network, well served by public transport, cycleways and footpaths. Part of the site is currently occupied by C.V. Apparel Ltd for their sports and social club activities, and until recently by Sutton Harriers, a long established athletics club. The remainder of the site comprises an area of open space used by the local community, and an area of former allotment land.
- 7.39 Because of its strategic highway location and accessibility to public transport, the site is considered to be well suited to comprehensive development for housing, non food retail open space and road related uses including hotel accommodation and potentially restaurant facilities. The non food retail provision for this site is made on the basis that proposals are to be for bulky goods only and for one single user. This allocation is made on the basis of an identified need for non food retail floorspace shown in the retail chapter. This floorspace requirement cannot be wholly accommodated either within or adjoining existing town centres. This site subsequently satisfies the sequential approach to identifying retail sites outlined in the retail chapter as no suitable alternatives are available although retail developers will need to demonstrate that any proposals are in accordance with the requirements of policy SH3.
- 7.40 Any development of this site will be subject to the relocation of the existing sports and social club and associated playing pitches, alternative provision for the athletics club comprising an all weather surface track with associated facilities, the provision of 1.2 hectares of public open space adjacent to the western site boundary off Lawrence Crescent and also the retention of mature trees adjacent to the Mansfield Road frontage.

CHAPTER 8: RECREATION, TOURISM AND COMMUNITY SERVICES

INTRODUCTION

- 8.1 This chapter considers the provision of formal and informal sporting and recreational opportunities including organised sports requiring open spaces, pitches and built facilities and informal activities such as children's play, walking, cycling, horse riding and the use of allotments. Opportunities for tourism related development, particularly within the Greenwood Community Forest, and community services such as education, health and community centres are also considered. The Council recognises that the provision and improvement of opportunities for recreation and tourism is of major importance in improving the quality of life for the local community and for attracting tourists and other visitors to the District.

CENTRAL GOVERNMENT GUIDANCE

- 8.2 PPG17 'Sport and Recreation' outlines Government policy towards the role of the planning system in assessing opportunities and needs for sport and recreation provision and safeguarding open space with recreational value. It states that local plans provide the appropriate context in which to assess needs for recreational facilities, identify deficiencies in public open space, encourage suitable sites for recreational provision and include policies for the protection of both private and public open space and other land of recreational and amenity value. Open space is also recognised as an important component of new residential development either within the site or off-site where the use of planning obligations may be appropriate to secure its provision. Where the development is small scale, a contribution to nearby recreational or open space facilities may be more appropriate.
- 8.3 There are no prescribed national standards for the provision of open space. PPG17 uses the National Playing Fields Association (NPFA) minimum standard for the provision of Outdoor Playing Space as an illustrative guide. This states that there should be 2.43 hectares of Outdoor Playing Space per 1,000 population and that this should comprise formal sports areas for youths and adults and playspace for children. The guidance note indicates that the applicability of such standards to an area is a matter for the Local Planning Authority's judgement.
- 8.4 The guidance also recognises the importance of playing fields, regardless of ownership, in satisfying recreational needs and contributing to local amenity. PPG17 indicates that local plans should include a statement of the community's requirements for sports pitches and policies on the protection of playing fields and that playing fields should normally be protected, particularly where the Local Plan shows that there is no excess of sports pitch provision.
- 8.5 PPG21 'Tourism' considers the economic significance of tourism and its environmental impact and considers policies for facilitating tourist development particularly as an element of regeneration.
- 8.6 PPG12 'Development Plans' refers to the importance of considering the capacity of existing, and the need for new, community infrastructure including education and health facilities.

STRUCTURE PLAN REVIEW

- 8.7 The Nottinghamshire Structure Plan Review gives strategic guidance on recreation, tourism and community services. Policies 1/1(i) and 1/2 refer to the need to protect and provide adequate open space in order to meet recreational needs. Policy 7/1 favours the development of recreational facilities in specified types of location and indicates priorities. Policy 7/2 provides guidance on the protection of open space and provision both in areas of need and new developments. The need to maintain and improve the existing network of rights of way and other recreational routes is outlined in Structure Plan policy 7/4. Policies 7/5 and 7/6 provide a context for tourist-related proposals. The provision of new educational, social, health and community facilities is considered in policy 8/1.

RECREATION, TOURISM AND COMMUNITY SERVICES OBJECTIVES

- 8.8
- To assess needs and opportunities for sport and recreation provision.
 - To protect land used for sport and recreational purposes and identify opportunities for new land to meet shortfalls in recreation provision.
 - To protect allotment land required to meet anticipated needs.
 - To consider needs for increased access to open space and the countryside and to safeguard potential recreational routes.
 - To consider the potential for tourist-related development and particularly the recreational benefits associated with the Greenwood Community Forest.
 - To consider requirements for new community, educational and health facilities.

OPEN SPACE

- 8.9 Many different types of open space exist within the District serving both formal and informal recreational needs as well as providing green open spaces and corridors within and adjoining urban areas used by the public and also by wildlife. This section of the chapter considers all open spaces in terms of their purpose and role, the needs of local communities for different types of open space, the adequacy of such provision and the need for additional open space. Four different types of open space in the District have been categorised by their role and function and are identified below.

Type	Description/function
Country Parks Outside Main Urban Areas and Named Settlements	Large public open spaces generally over 30 Ha maintained as informal open space. Located outside Main Urban Areas. Serving district and sub-regional needs for informal recreation including walking, cycling and horseriding.
Open Areas in Main Urban Areas and Named Settlements	Open spaces ranging in size from 1.5 Ha to 94 Ha usually with public access. Maintained as informal open space. Located within urban areas. Where public access is permitted they serve the local needs of Ashfield residents for informal recreation including walking, cycling and horseriding. Also provide open breaks and green corridors in urban areas.
Formal Open Space (including Outdoor Playing Space)	Open space ranging in size from 0.2 Ha to 28 Ha generally with public access. Located in or adjacent to urban areas. Maintained as formal open space for organised sport and recreation, play space for youths and children and as formally landscaped areas. Includes Outdoor Playing Space which is available for public use, the provision of which can be assessed using the National Playing Fields Association methodology.
Allotments	Public and privately owned. Located within and directly adjacent to the urban areas. Directly serving the local needs of Ashfield residents for growing food or other gardening purposes. Also provide open breaks in urban areas.

COUNTRY PARKS OUTSIDE MAIN URBAN AREAS AND NAMED SETTLEMENTS

- 8.10 A number of country parks lie within and directly adjoining the District serving the needs of communities in Ashfield and also assisting in the promotion of the District to tourists and day visitors. These open spaces are generally large, openly accessible to the public and lie outside the Main Urban Areas and Named Settlements. They are maintained as informal open space some of which comprise restored and landscaped former derelict land and colliery spoil heaps which further contribute to the Greenwood Community Forest. Informal recreational activities including walking, cycling and horseriding are generally catered for, and often trail networks have been developed to link these country parks and other open areas of land.

- 8.11 Open spaces of this type in Ashfield include Mill Lakes and the River Leen Corridor and Dob Park at Hucknall; Portland Park between Annesley and Kirkby; Annesley Forest; Nomanshill Wood and Thieves Wood, east of Kirkby; Brierley Forest Park, Teversal Trails, Kingsmill Reservoir and the former Silverhill Colliery Site near the Sutton, Huthwaite, Skegby and Stanton Hill areas and the River Erewash corridor including Jacksdale Nature Reserve. Open spaces of this type lying outside but directly adjacent to Ashfield and serving Ashfield residents include Moorgreen Reservoir and adjoining woodland, Newstead Abbey, Bulwell Hall Park and Hardwick Park.
- 8.12 The District is well served by this type of open space which, whilst situated outside the urban areas, often adjoins or lies in close proximity to residential areas. The open spaces listed above are generally of a size where, in addition to regular use by local residents, weekend or occasional visits by residents from other areas may be expected either by car or public transport. Most Ashfield residents live within 2km of at least one of these areas and virtually all live within 3km and as such they will be easily accessible by foot or cycle.
- 8.13 The open spaces of this type that lie within Ashfield are not protected through specific designations in the Local Plan but will be generally protected through policies EV1 and EV2 relating to the Green Belt and Countryside, and other policies in the Environment Chapter protecting Sites of Importance for Nature Conservation and Mature Landscape Areas.

NEW INFORMAL OPEN SPACE

POLICY RC1 LAND WILL BE PROVIDED FOR NEW INFORMAL OPEN SPACE IN ASSOCIATION WITH ADJACENT PROPOSED RESIDENTIAL ALLOCATIONS AS SHOWN ON THE PROPOSALS MAP AT:-

Hucknall

Ha PAPPLEWICK LANE/RIVER LEEN

Kirkby-in-Ashfield

Ka LINDLEYS LANE/PORTLAND COUNTRY PARK

A PLANNING CONDITION WILL BE IMPOSED OR PLANNING OBLIGATIONS NEGOTIATED, AS APPROPRIATE, TO SECURE THE PROVISION OF THESE AREAS.

- 8.14 Whilst communities in the District are generally well served by this type of informal open space, the proposed allocation of large new residential sites, in particular, may bring additional demands for new informal open spaces and increase pressures on existing Country Park areas. Consequently New Informal Open Space has been identified as a requirement of the proposed housing sites at Papplewick Lane (HG1Ho) and Lindleys Lane (HG1Ka). This recognises the need to provide managed and publicly accessible informal open space principally for residents on these large sites, particularly as unauthorised access to these areas would otherwise cause problems. This will disperse and minimise additional pressures on the Mill Lakes Country Park area to the south of the Papplewick Lane site and Portland Country Park adjacent to the Lindleys Lane site. The proposed New Informal Open Spaces are identified in policy RC1 above. These two areas are considered to be an important and integral consideration to the proposed housing sites and will be required to be provided as part of any development scheme on these sites secured through the use of planning conditions or planning obligations as appropriate.

OPEN AREAS IN MAIN URBAN AREAS AND NAMED SETTLEMENTS

POLICY RC2 DEVELOPMENT IN OPEN AREAS WILL NOT BE PERMITTED EXCEPT FOR ASSOCIATED RECREATIONAL USES WHICH MAINTAIN THE OPEN CHARACTER OF THE AREA.

Existing Open Areas are listed below and shown on the Proposals Map.

Hucknall

Ha	WATNALL ROAD
Hb	COMMON FARM
Hc	POLPERRO LAGOONS
Hd	WIGWAM LANE WEST
He	LAND AT WASHDYKE LANE
Hf	FORMER LINBY COLLIERY SPOIL HEAP

Kirkby-in-Ashfield

Ka	LIME STREET
Kb	CHAPEL STREET/LINDRICK ROAD
Kc	NORTH WEST OF ASHFIELD COMMUNITY HOSPITAL
Kd	LAND SOUTH OF KINGS MILL ROAD EAST
Ke	LAND NORTH OF KINGS MILL ROAD EAST
Kf	SOUTH OF ODDICROFT LANE
Kg	SOUTH OF KIRKBY HARDWICK

Sutton-in-Ashfield

Sa	LAND BETWEEN MILL LANE AND ALFRETON ROAD
Sb	SKEGBY QUARRIES

Named Settlement**Selston**

Ra	SELSTON COMMON
Rb	HOLLY HILL, SELSTON.

- 8.15 A number of other areas of open space not maintained for formal recreational use also lie within the Main Urban Areas and Named Settlements of the District adjoining residential areas. Often these are linked by trails to the Country Parks described in paragraphs 8.10-8.13 above. The Open Areas are generally large areas of land although smaller areas are identified where these act as important open breaks. They are both publicly and privately owned and function as open breaks or green corridors and, where access is permitted, directly serve the informal recreational needs of local residents for walking, cycling and horseriding. The Open Areas also serve as important wildlife habitats and corridors some of which have been identified through the Urban Green Spaces Survey carried out by the Nottinghamshire Wildlife Trust and Groundwork Ashfield and Mansfield.
- 8.16 The Open Areas that are publicly accessible, together with the Country Parks that adjoin residential areas referred to in paragraph 8.11 above directly serve the informal recreational needs of Ashfield residents. The majority of residents live within 1km of one or more of these areas and all live within 2km. Consequently most residents will be able to walk or cycle to those areas with public access. The need to protect existing open spaces of this type for recreational activities and as open breaks within Main Urban Areas and Named Settlements is recognised in policy RC2 above. The Council will continue to identify opportunities to provide new, and improve existing, informal open spaces of this type all of which contribute to the Greenwood Community Forest.

- 8.17 Land at Watnall Road (RC2Ha) is part of a larger restored former colliery spoil heap which contributes to the "green corridor" along this part of the Hucknall By-Pass. Land at Common Farm (RC2Hb) and Polperro Lagoons (RC2Hc) provide open breaks within existing residential areas, the former having also been tree planted as part of the Greenwood Community Forest initiative. A similar tree planted open space has been created on a restored colliery spoil heap at Wigwam Lane West (RC2Hd). Land adjacent to Washdyke Lane (RC2He) contributes to the overall open nature of the area and the "green corridor" along the Hucknall By-pass, particularly when considered with the adjoining allotments and playing fields. A major Open Area is identified on the former Linby Colliery Spoil Heap (RC2Hf). This area has been reclaimed and landscaped as a parkland with extensive tree planting.
- 8.18 Former railway land has been tree planted to create open breaks and green corridors in Kirkby-in-Ashfield on land at Lime Street (RC2Ka), on a corridor of land from Chapel Street to Lindrick Road (RC2Kb) and to the northwest of Ashfield Community Hospital (RC2Kc). The Lime Street site links to Portland Country Park and will link to the proposed informal open space (RC1Ka) to be provided as part of the Lindleys Lane residential allocation (HG1Ka). The Chapel Street to Lindrick Road green corridor provides a footpath and cycleway to link with the former Summit Colliery spoil heaps (RC2Kf and RC2Kg) which have been restored and landscaped. These two large open areas and land to the north and south of Kings Mill Road East (RC2Kd and RC2Ke) provide an important open break between Kirkby-in-Ashfield and Sutton-in-Ashfield and contribute to the green corridor along the A38.
- 8.19 A considerable open area of land is identified between Mill Lane and Alfreton Road at Sutton-in-Ashfield/Huthwaite (RC2Sa). Some of this area has been restored to allow public access and part contains the Sutton Landfill site currently in use for the disposal of domestic waste. Planning permission has been granted to the waste disposal company operating the site for the phased restoration of this area as a new recreational parkland on completion of the landfilling. Phased restoration commenced in 1999 which will significantly increase the area of land open to the public on this site allowing development of further linkages with other nearby open spaces, country parks and trails. A Greenwood Community Forest tree planted site provides an informal area of open space at Skegby Quarries (RC2 Sb) on Mansfield Road.
- 8.20 Selston Common (RC2Ra) and Holly Hill (RC2Rb) provide a substantial and prominent open break within Selston. The latter area has been restored and landscaped for public use.

FORMAL OPEN SPACE

POLICY RC3 DEVELOPMENT WHICH WOULD LEAD TO THE LOSS OF FORMAL OPEN SPACE WILL ONLY BE PERMITTED WHERE:-

- a) **IT IS ANCILLARY TO THE RECREATIONAL USE, OR**
- b) **IT WOULD ASSIST IN THE RETENTION AND ENHANCEMENT OF THE RECREATIONAL USE OF THE SITE, OR**
- c) **ADEQUATE REPLACEMENT PROVISION OF NEW FORMAL OPEN SPACE IS PROVIDED IN THE LOCALITY, OR**
- d) **IT IS PROPOSED TO MAKE A SIGNIFICANT IMPROVEMENT TO THE OVERALL QUALITY OF RECREATION PROVISION IN THE LOCALITY, OR**
- e) **IN THE CASE OF SCHOOL PLAYING FIELDS THE DEVELOPMENT IS REQUIRED FOR EDUCATIONAL PURPOSES.**

A PLANNING CONDITION WILL BE IMPOSED OR PLANNING OBLIGATION NEGOTIATED, AS APPROPRIATE, TO SECURE OFF SITE PROVISION OF FORMAL OPEN SPACE OR OTHER FACILITIES.

Existing Formal Open Spaces are listed below and shown on the Proposals Map:

		Hectare s
Hucknall		
Ha	LIME TREE ROAD RECREATION GROUND	0.8
Hb	BROOMHILL JUNIOR SCHOOL*	1.8
Hc	JENNY BURTON WAY	0.5
Hd	BUTLERS HILL RECREATION GROUND	2.0
He	FARLEYS LANE	0.4
Hf	TITCHFIELD PARK	10.9
Hg	ROLLS ROYCE SPORTS GROUND	3.3
Hh	LANCASTER ROAD	1.0
Hi	KINGSWAY GARDENS	1.3
Hj	EDGEWOOD PRIMARY SCHOOL	0.9
Hk	MILTON RISE	0.2
HI	HUCKNALL TOWN FOOTBALL CLUB	2.3
Hm	NABBS LANE RECREATION GROUND	3.0
Hn	ANNIE HOLGATE COMPREHENSIVE SCHOOL	13.4
Ho	ANNIE HOLGATE JUNIOR SCHOOL	2.6
Hp	GARDEN ROAD	0.7
Hq	WOOD LANE*	0.3
Hr	WHYBURN PRIMARY SCHOOL	1.2
Hs	GREENWOOD VALE *	1.4
Ht	WASHDYKE LANE RECREATION GROUND	2.4
Hu	NATIONAL COMPREHENSIVE SCHOOL	5.0
Hv	LAND EAST OF BROXTOWE DRIVE	2.3
Hw	HUCKNALL NATIONAL JUNIOR SCHOOL	0.7
Hx	ALBERT STREET RECREATION GROUND	1.2
Hy	WIGWAM LANE PLAYING FIELD	1.0
Hz	LEEN MILLS PRIMARY SCHOOL	1.9
Haa	HOLY CROSS ROMAN CATHOLIC PRIMARY SCHOOL	0.5
Kirkby-in-Ashfield		
Ka	ANNESLEY MINERS WELFARE	2.2
Kb	ANNESLEY PRIMARY SCHOOL	1.3
Kc	ACACIA AVENUE RECREATION GROUND	1.7
Kd	SKEGBY ROAD RECREATION GROUND	0.9
Ke	KIRKBY WOODHOUSE PRIMARY	1.0
Kf	KINGSWAY PRIMARY SCHOOL*	1.5
Kg	KINGSWAY PARK	8.1
Kh	ORCHARD PRIMARY SCHOOL*	0.7
Ki	BENTINCK MINERS WELFARE	2.3
Kj	JEFFRIES SCHOOL	0.2
Kk	FORSTER STREET	1.7
Kl	BRSA SPORTS GROUND	1.1
Km	MORVEN PARK	2.3
Kn	COXMOOR PRIMARY SCHOOL	0.6
Ko	ASHFIELD UNITED FC	2.8
Kp	DAVID STREET	0.9
Kq	GREENWOOD PRIMARY SCHOOL	0.9
Kr	ROWAN DRIVE	0.6
Ks	ASHFIELD COMPREHENSIVE SCHOOL	11.0
Kt	SUMMERFIELDS ROAD	0.4
Ku	ORCHID CLOSE	0.5
Kv	ODDICROFT LANE	2.1
Kw	ODDICROFT LANE NORTH	1.9

Sutton-in-Ashfield

Sa	ROUND RECREATION GROUND	1.9
Sai	LAND ADJOINING HILLOCKS PRIMARY & NURSERY SCHOOL	0.3
Sb	TAYLOR CRESCENT RECREATION GROUND	0.6
Sc	LEAMINGTON PRIMARY SCHOOL*	1.8
Sd	COWPASTURE LANE RECREATION GROUND	2.6
Se	ASHFIELD PARK	2.4
Sf	HARDWICK LANE RECREATION GROUND	1.1
Sg	THE LAWN	28.8
Sh	UNWIN ROAD SPORTS GROUND	4.2
Si	MAPPLEWELLS PRIMARY SCHOOL*	0.4
Sj	CHARWOOD STREET RECREATION GROUND	2.2
Sk	PEVERIL DRIVE	2.2
Sl	HUTHWAITE ROAD	1.7
Sm	BETTS AND BROUGHTON SPORTS GROUND	0.8
Sn	HUTHWAITE WELFARE PARK	3.1
So	SPRINGWOOD VIEW CLOSE	1.2
Sp	ST. MARY'S PRIMARY SCHOOL*	0.7
Sq	LAMMAS ROAD RECREATION GROUND	1.7
Sr	JUBILEE CYCLE TRACK	0.4
Ss	WESTBOURNE ROAD	0.5
St	CARSIC JUNIOR SCHOOL*	1.2
Su	THE OVAL RECREATION GROUND	0.5
Sv	DAVIES AVENUE	0.3
Sw	PRIESTSIC ROAD RECREATION GROUND	0.9
Sx	PRIESTSIC PRIMARY SCHOOL*	0.3
Sy	STONEFYORD ROAD RECREATION GROUND	2.1
Sz	QUARRYDALE ROAD	3.4
Saa	HILL CRESCENT	2.0
Sab	DALESTORTH PRIMARY SCHOOL*	1.0
Sac	QUARRYDALE COMPREHENSIVE SCHOOL	7.3
Sad	STAMPER CRESCENT RECREATION GROUND	3.0
Sae	ST. ANDREWS C OF E PRIMARY SCHOOL	1.1
Saf	BRAND LANE	0.6
Sag	HEALDSWOOD RECREATION GROUND	4.5
Sah	DANESWOOD JUNIOR SCHOOL*	0.7
Sai	LAND ADJOINING HILLOCKS PRIMARY AND NURSERY SCHOOL	0.3

Named Settlements

Underwood

Na	UNDERWOOD MINERS WELFARE	1.2
Nb	UNDERWOOD C OF E PRIMARY SCHOOL*	0.3
Nc	CHURCH LANE RECREATION GROUND	1.6

Jacksdale

Nd	JACKSDALE MINERS WELFARE	1.2
----	--------------------------	-----

Selston

Ne	NOTTINGHAM ROAD RECREATION GROUND	2.0
Nf	SOUTH OF NOTTINGHAM ROAD	0.6
Ng	MATTHEW HOLLAND COMPREHENSIVE SCHOOL	4.1
Nh	SELSTON PARISH HALL	1.7
Ni	HOLLY HILL PRIMARY SCHOOL	1.0

Nj	COLUMBIA CLOSE PLAY AREA	0.2
Nk	PORTLAND ROAD	0.7
NI	GREEN FARM ROAD RECREATION GROUND	0.3
Nm	ALEXANDER AVENUE	0.3
Nn	VALENTINE AVENUE PLAY AREA	0.3

New Annesley

No	ANNESLEY ROWS	4.1
----	---------------	-----

Rural Area

Ra	SHELTON AVENUE, HUCKNALL	0.3
Rb	CHURCH LANE, HUCKNALL	2.1
Rc	NEW ANNESLEY RECREATION GROUND	1.2
Rd	CRICKETERS ARMS, ANNESLEY	1.6
Re	NUNCARGATE RECREATION GROUND, ANNESLEY	1.5
Rf	MAYFIELD RECREATION GROUND, KIRKBY	1.3
Rg	TICHFIELD PARK, KIRKBY	2.9
Rh	CONISTON ROAD, KIRKBY	1.9
Ri	BEACON DRIVE, KIRKBY	1.2
Rj	ROKER PARK, HUTHWAITE	2.5
Rk	JOHN DAVIES PRIMARY SCHOOL, HUTHWAITE	2.4
RI	CLEGG HILL DRIVE RECREATION GROUND, HUTHWAITE	0.8
Rm	WOODLAND AVENUE, HUTHWAITE	1.0
Rn	MEDEN BANK, STANTON HILL	0.5
Ro	TEVERSAL GRANGE	4.9
Rp	TEVERSAL RECREATION GROUND	0.8
Rq	FELLEY MILL LANE, UNDERWOOD	1.6
Rr	SOUTH OF MAIN ROAD, UNDERWOOD	0.5
Rs	BAGTHORPE PRIMARY SCHOOL	0.5
Rt	MAIN ROAD, JACKSDALE	1.7
Ru	PYE HILL ROAD, JACKSDALE	4.0
Rv	PALMERSTON STREET, JACKSDALE	1.6
Rw	JUBILEE RECREATION GROUND	0.4
Rx	NEW SELSTON RECREATION GROUND	1.4

*** Site not included in NPFA Outdoor Playing Space assessment**

- 8.21 Unlike the Country Parks or Open Areas above, Formal Open Space is maintained for organised sport and recreation, play space for youths and children and as formally landscaped open space. This type of open space serves local need for formal recreation and is generally located within residential areas. These areas are over 0.2 hectare and are owned by local authorities, schools and private organisations.
- 8.22 Formal Open Space has been divided into two broad categories, Outdoor Playing Space and other Formal Open Space, in order to carry out an assessment of Outdoor Playing Space, as suggested by the National Playing Fields Association (NPFA). Both types of Formal Open Space are protected in the policy above. Formal Open Space not included in the NPFA Outdoor Playing Space assessment is specifically identified in policy RC3 with an asterisk.
- 8.23 Formal space should be protected from development particularly where there are deficiencies in provision as is the case in Ashfield. Exceptional circumstances do however arise where the loss of Formal Open Space may be acceptable. Proposals which are ancillary to the recreational use of the site and which add to its recreational value such as football changing rooms or a cricket pavilion may be acceptable where these are sited to minimise effects on the open character of the area. On private open spaces in particular it may be appropriate to allow limited development on a small part of the site where this would result in retention of the majority of the open space including upgrading of the facility and improved public use of the site. In the case of school playing fields, development required for educational purposes will be permitted particularly as this is

restricted by other legislation relating to the disposal of school playing fields. In some circumstances loss of an area of Open Space may be acceptable where a replacement facility is provided in the immediate locality serving the same local resident population. This may for instance include cases where an open space is required to enable the comprehensive development of an area. Where replacement formal sports facilities such as football pitches are to be provided these should be available for use prior to loss of the open space to be replaced. This will be negotiated and secured through a Section 106 Planning Obligation. Exceptionally, the loss of open space may also be acceptable where it is proposed to make a significant improvement in the type, quality and general availability of open space in the locality. This might for instance include the loss of an open space with restricted public access, or an open space with no formal play provision and the subsequent improvement of an existing nearby open space through the provision of formal sports facilities that are much needed in the locality and where general public access will be allowed. The loss of an existing open space and subsequent provision of an off-site replacement or improvement of facilities will need to be negotiated with the Local Planning Authority and will be secured by a planning condition or planning obligation as appropriate.

OUTDOOR PLAYING SPACE ASSESSMENT

- 8.24 Following a comprehensive survey of all Formal Open Space identified in policy RC3 above, an exercise has been carried out to assess the adequacy of provision of existing Outdoor Playing Space using the NPFA methodology. The NPFA guidance indicates that a minimum standard of 2.43 hectares of Outdoor Playing Space should be provided per 1000 population. Only sites which qualify as Outdoor Playing Space under the NPFA guidelines have been considered from the policy above. Further explanation of the Outdoor Playing Space assessment is provided in Technical Paper No. 5: 'Outdoor Playing Space and Playing Pitches'.
- 8.25 Table 8.2 below indicates the level of provision of Outdoor Playing Space at the time of survey in 1997 using the 1997 mid-year population estimates for each community catchment area which includes Hucknall, Kirkby-in-Ashfield, Sutton-in-Ashfield and the Named Settlements west of the M1. It shows the total NPFA minimum land requirement for Outdoor Playing Space for each community area according to the 2.43 hectares per 1000 population standard and compares this against the Outdoor Playing Space available as identified in policy RC3 above. The Outdoor Playing Spaces in the Rural Areas and New Annesley in policy RC3 are assigned to the nearest town or to the Named Settlements west of the M1 for the purposes of the assessment.

Area	1 Population Mid - 1997 Estimates	2 Minimum NPFA Standard 2.43Ha/ 1000 population	3 Outdoor Playing Space (Policy RC3)	4 Balance of Outdoor Playing Space (2 minus 3)
Hucknall	29,380	71.4	61.9	-9.5
Kirkby-in-Ashfield	26,580	64.6	60.2	-4.4
Sutton-in-Ashfield	40,305	97.9	95.5 *	-2.4
Named Settlements (West of M1)	12,135	29.5	26.9	-2.6
DISTRICT TOTAL	108,400	263.4	244.5	-18.9

*Includes 1.2 hectares of open space at Lawrence Crescent (see policy SH10)

- 8.26 Table 8.2 indicates that there is a small shortfall in the NPFA minimum requirement for Outdoor Playing Space in all community catchment areas and a deficit of 18.9 hectares in the District as a whole, which reaffirms the need to protect these areas as identified in policy RC3. Particular difficulties are evident in Hucknall, Kirkby-in-Ashfield and the Named Settlements. The current shortfall will, to some extent, be compensated for by incidental or casual use of the Country Parks and Urban Open Areas as Outdoor Play Space and could be partly addressed by better community use of school playing fields. A total of 10.4 hectares of school playing fields in the District is not currently available for community use. The proposed new open space referred to in

policy RC4 and Table 8.3 below will also contribute to current as well as future needs.

- 8.27 The NPFA Standard does not address the general distribution of outdoor playing space within each community area. In general most Ashfield residents live within walking distance (400 metres) from at least one area of Outdoor Playing Space.
- 8.28 This Plan addresses housing development needs to 2011 and as such the additional population accommodated in the District will bring additional needs for Outdoor Playing Space. The NPFA standard can also be applied therefore to population projections to assess future needs. The population projections provided by the Structure Plan Review are however only provided for the West Notts. and South Notts. Structure Plan Sub-Areas and not for each community area as shown in Table 8.2 above. Table 8.3 below therefore assesses future needs for Outdoor Playing Space, by sub area only, and indicates the total projected requirement at 2011, including current requirements from Table 8.2.

Area	1 Population Projection to 2011*	2 Minimum NPFA Standard 2.43Ha/ 1000 population	3 Outdoor Playing Space aggregated from table 8.2	4 Balance of Outdoor Playing Space (2 - 3)
South Notts. (Hucknall)	31,900	77.5	61.9	-15.6
West Notts. (Kirkby, Sutton and Named Settlements)	84,000	204.0	182.6	-21.4
DISTRICT TOTAL	115,900	281.5	244.5	-37

*Nottinghamshire County Council population projections.

- 8.29 It is clear from Table 8.3 above that significant areas of additional Outdoor Playing Space will be required to meet future needs. This shortfall can generally be met in three ways,
- The provision of specific areas of new Formal Open Space
 - General requirements for the provision of at least 10% of new open space on residential sites in excess of two hectares (see policy HG6)
 - The use of commuted sum payments arising from small housing developments, for off-site open space provision where on-site provision is not required (see policy HG6).

NEW FORMAL OPEN SPACE

POLICY RC4 LAND WILL BE PROVIDED FOR NEW FORMAL OPEN SPACE IN ASSOCIATION WITH ADJACENT PROPOSED RESIDENTIAL ALLOCATIONS AS SHOWN ON THE PROPOSALS MAP AT:-

	Hectares
Hucknall	
Ha PAPPLEWICK LANE	7.5
Kirkby-in-Ashfield	
Ka SOUTH OF KINGSWAY PARK	1.2

A PLANNING CONDITION WILL BE IMPOSED OR PLANNING OBLIGATION NEGOTIATED, AS APPROPRIATE TO SECURE THE PROVISION OF THESE AREAS.

- 8.30 The provision of specific areas of New Formal Open Space as a requirement of a residential scheme is referred to in detail in the Housing Chapter and in the associated briefs for specific housing sites. In particular the proposed housing site at Papplewick Lane, Hucknall (HG1Ho) will

involve the relocation of existing playing fields at Wigwam Lane and the provision of additional open space such that there will be a net gain of 7.5 hectares of open space including a net gain of two playing pitches. Site specific open space provision, to be made in association with residential allocations is identified in policy RC4 above and shown on the Proposals Map.

- 8.31 Some of the residential land allocations in policy HG1 will not have a site specific requirement for open space but will be required to provide a minimum of 10% of the gross housing area as open space at a location to be agreed at the detailed planning stage. These residential allocations are identified in Appendix 5. The open space provided will principally be for new playing pitch and children's play facilities, which qualify as outdoor playing space under National Playing Fields Association guidelines. The likely provision of open space from this source for each District Sub Area to 2011 will be as follows:-

Sub-Area	Total Open Space Provision (Hectares) (10% Gross Housing Area)
South Notts. (Hucknall)	5.1
West Notts. (Kirkby Sutton and Named Settlements)	1.7

- 8.32 The NPFA requirements for Outdoor Playing Space provision to 2011 in Table 8.3 can be compared with the likely future provision of new Outdoor Playing Space in policy RC4 and Table 8.4 above as follows:-

Area	1 Deficit to 2011 (table 8.3)	2 Proposed Site Specific Open space (Policy RC4)	3 Proposed Non Site Specific Open Space (table 8.4)	4 Balance (1+2+3)
South Notts. (Hucknall)	-15.6	7.5	4.6	-3.5
West Notts. (Kirkby, Sutton and Named Settlements)	-21.4	1.2	0.5	-19.7

- 8.33 In the South Notts. Sub Area the provision of new Outdoor Playing Space will address requirements to 2011. However there is a shortfall of Outdoor Playing Space in the West Notts. Sub-Area reflecting the smaller residential site allocations which are less able to offer the same level of new open space provision. There is therefore a need to further investigate the creation of additional new Outdoor Playing Space in the West Notts. Sub-Area. The use of commuted sum payments from housing developments for off-site open space provision is a potential means to address this shortfall. Reference to Table 8.2 suggests there are particular shortfalls in the Kirkby-in-Ashfield and Named Settlements parts of West Notts. and enhancement or provision of new Outdoor Playing Space in these areas should be considered a priority.

PLAYING PITCH ASSESSMENT

- 8.34 An important part of Outdoor Playing Space provision is the availability of playing fields for pitch based sports including football, cricket, rugby and hockey. It is important to assess the adequacy of playing pitch provision as the specific formal needs of those using the pitches may not be easily accommodated on other open space and because of the difficulties involved in replacing pitches lost to development. Detailed consideration is given to the assessment of playing pitch provision in Technical Paper No.5: 'Outdoor Playing Space and Playing Pitches'.
- 8.35 An assessment of pitch provision was carried out in 1997/8 to identify playing pitches available for regular use and to assess the requirements of existing and potential pitch users. This was based on the Sports Council's advice in their publication 'The Playing Pitch Strategy'. The Method involves comparing supply against peak demand for pitches by identifying teams playing on given

days and matching this against the known availability of pitches. It was recognised that a simple quantitative exercise which counted supply of pitches against demand did not necessarily reflect the known shortages of pitches from anecdotal evidence. Consequently a questionnaire was sent to football teams, who comprise by far the largest team based sport, both playing within and also outside of Ashfield where they have local connections. This attempted to establish what difficulties the teams had with pitch quality, if they wished to establish new teams but were prevented by a lack of pitches and if the existing teams had been forced to play away from their preferred area due to a lack of pitches.

- 8.36 Some 70% of questionnaires were returned which indicated that a number of clubs had wished to form new teams but were prevented from doing so and a small number of teams currently playing outside the District wished to move to a pitch nearer to their natural home base within Ashfield. Teams also commented on the pressure placed on existing pitches which were often substandard playing areas as a result of overuse.
- 8.37 This qualitative approach can only give a general impression of the shortage of pitches in the District. However it is clear that there are currently local difficulties in providing playing pitches particularly in the Hucknall area.
- 8.38 The provision of new open space as part of the residential allocations in the Local Plan will however assist in addressing this problem. In particular it is estimated that in Hucknall, taking into account the loss of part of the Wigwam Lane playing fields, a net gain of five playing pitches could be provided on new open space over the plan period to 2011. It is also estimated that a further two playing pitches could be provided on new open space in Kirkby-in-Ashfield and two at Sutton-in-Ashfield. Furthermore the availability of commuted sum payments from small housing developments for off-site open space could be used to assist with provision of new playing pitches and changing rooms on existing open spaces in the District that do not currently include formal pitches.

ALLOTMENTS

POLICY RC5 DEVELOPMENT ON ALLOTMENT LAND WILL ONLY BE PERMITTED WHERE:-

- a) **IT IS DEMONSTRATED THAT THE ALLOTMENTS ARE NO LONGER REQUIRED, OR**
- b) **APPROPRIATE ALTERNATIVE PROVISION IS MADE WITHIN THE LOCALITY.**

Protected Allotments are listed below and shown on the Proposals Map:-

Hucknall

**Ha RUFFS FARM
Hb BUTLERS HILL
Hc LONG HILL RISE
Hd WOOD LANE/A611
He WIGWAM LANE
Hf LINBY ROAD EAST
Hg ST. MARY'S WAY
Hh WIGHAY
Hi WASHDYKE LANE**

Kirkby-in-Ashfield

**Ka FOREST ROAD
Kb WESLEY STREET
Kc SHERWOOD RISE
Kd KINGSWAY
Ke FORSTER STREET**

Kf SUTTON ROAD
Kg DIAMOND AVENUE

Sutton-in-Ashfield

Sa CALLADINE LANE
Sb JUBILEE GARDENS
Sc MILL LANE, HUTHWAITE
Sd MILLDALE WALK
Se LANE END
Sf BRAND LANE, STANTON HILL
Sg WHARF ROAD, STANTON HILL
Sh NEW LANE, STANTON HILL

Named Settlements

Selston

Na MANSFIELD ROAD

Underwood

Nb CORDY LANE

Rural Area

Ra LIME TREE ROAD, HUCKNALL
Rb PLAINSPOT ROAD, BRINSLEY
Rc SCHOOL ROAD, BAGTHORPE
Rd WESTWOOD GARDENS, WESTWOOD
Re NOTTINGHAM ROAD, SELSTON
Rf CHURCH GARDENS, KIRKBY
Rg CALIFORNIA, KIRKBY
Rh GARDEN GAP, HUTHWAITE
Ri MAIN STREET, HUTHWAITE

8.39 Allotments provide a social, recreational and economic resource for allotment holders, and contribute to wider sustainability objectives in adding to the natural diversity of an area. Allotment sites listed above are owned by either the District Council, Selston Parish Council, or privately, most often through allotment associations. The loss of allotment land will only be permitted where it can be clearly demonstrated that the allotments are no longer required or alternative provision is made in the locality. Disposal of 'statutory' allotment land will require consent from the Secretary of State for the Environment Transport and Regions under Section 8 of the Allotments Act 1925.

8.40 As part of the Urban Capacity exercise a survey of allotment land and the use of allotment plots has been carried out to assess the level and adequacy of provision. The survey is detailed in Technical Paper No.6: 'Allotments'. Large numbers of allotment plots are either disused or used for grazing i.e. not for the purpose intended and a use which is more appropriate in the urban fringe and countryside. This reflects a general decline in interest and usage of allotment land in the District over a number of years. Detailed consideration of the proposed reuse for development of some of these allotment areas which are particularly poorly used is also given in Technical Paper No.6.

CEMETERIES

8.41 Following consultation with the Leisure Services section of the Council it is not anticipated that additional land will be required for cemeteries based on expected need to 2011. However, difficulties have been experienced in providing graves in Hucknall due to ground conditions and this position will be monitored through the plan period and land identified for new cemetery use should this be required.

INDOOR LEISURE FACILITIES**POLICY RC6 LAND IS SAFEGUARDED FOR INDOOR LEISURE FACILITIES AT:-**

Kirkby-in-Ashfield	Hectares
Ka ADJACENT FESTIVAL HALL, LINDLEYS LANE	0.4

8.42 A variety of recreational opportunities are available at leisure facilities operated by a number of bodies. Ashfield District Council operates a sports centre and swimming pools at Hucknall and Sutton-in-Ashfield and a leisure centre at the Festival Hall in Kirkby-in-Ashfield. It also runs smaller sports facilities at Selston and Huthwaite Leisure Centres. At Sutton Centre, the District and County Councils share responsibility for the comprehensive sporting facilities which are available on a joint school and community basis. Swimming facilities at Ashfield Comprehensive School, Kirkby-in-Ashfield and swimming and sports facilities at Edgewood Drive, Hucknall are also available on occasions to the general public. There is also a variety of private sports clubs in the District including squash facilities at Hucknall and Skegby.

8.43 Swimming facilities in Hucknall and Sutton-in-Ashfield are of a high quality. However, as no such provision is currently available in Kirkby-in-Ashfield, land is protected in policy RC6 adjacent to the Festival Hall for future leisure development.

INDOOR LEISURE FACILITIES OUTSIDE DISTRICT SHOPPING CENTRES**POLICY RC7 INDOOR LEISURE FACILITIES OUTSIDE DISTRICT SHOPPING WILL BE PERMITTED WHERE:**

- a) **THE SITE CAN BE DEMONSTRATED TO BE ACCEPTABLE USING THE SEQUENTIAL APPROACH,**
- b) **DEVELOPMENT WOULD NOT DIRECTLY, OR WHEN CONSIDERED TOGETHER WITH ANY OTHER COMMITTED SCHEMES LIKELY TO BE DEVELOPED IN THE SHORT TERM, SERIOUSLY AFFECT THE VITALITY AND VIABILITY OF ANY EXISTING NEARBY DISTRICT SHOPPING CENTRES,**
- c) **IT WOULD BE ACCESSIBLE BY A CHOICE OF MEANS OF TRANSPORT,**
- d) **IT WOULD BE WELL RELATED TO THE MAIN ROAD NETWORK,**
- e) **IT WOULD NOT GIVE RISE TO UNACCEPTABLE VEHICULAR AND/OR PEDESTRIAN TRAFFIC CONDITIONS,**
- f) **PARKING PROVISION IS IN ACCORDANCE WITH COUNCIL STANDARDS, AS OUTLINED IN APPENDIX 7, AND**
- g) **IT WOULD NOT LEAD TO UNACCEPTABLE INCREASES IN JOURNEYS BY PRIVATE CAR.**

8.44 The commercial leisure industry can also make a significant contribution to recreational opportunity and can assist in enhancing the daytime and evening economy of town centres. Recent years have seen a national increase in demand for leisure uses including bingo, multiplex cinemas and bowling alleys often developed together with complementary uses such as restaurants, cafes and pubs. PPG 6 addresses the issue of the leisure industry and the location of leisure developments. Major leisure developments which are likely to attract a lot of people including multiplex cinemas and larger bingo halls and bowling alleys should preferably be located within District Shopping Centres in accordance with policy SH1. Such proposals would have a positive effect on the vitality and viability of those Centres. The Local Plan specifically identifies sites for potential leisure development in District Shopping Centres on land at Amber Business Park (former Hucknall Colliery), EM1 Hh and Outram Street, Sutton-in-Ashfield, SH2 Sa. Where proposals cannot be accommodated in District Shopping Centres the next preference will be edge of Centre sites and then out of Centre sites where these are, or can be made, accessible by public transport. Evidence will need to be provided using the sequential approach that suitable alternative

sites are not available nearer to District Shopping Centres. Traffic generation and car parking will be a major consideration in respect of large scale proposals as will the potential for integrating the site with public transport provision, cycleways and footpaths. Potential disturbance to residents, building design and landscaping will also need to be carefully considered in any proposal to ensure a high standard of development in accordance with policy ST1 and SH6.

- 8.45 Other smaller leisure developments that do not fall within the scope of policy RC7 such as pubs, restaurants and small snooker and bingo halls will be determined against policies ST1 and SH6 and other relevant policies in the Plan.

RECREATIONAL ROUTES

POLICY RC8 DEVELOPMENT ON EXISTING FOOTPATHS, CYCLEWAYS AND BRIDLEWAYS AND ON DISUSED RAILWAY LINES AND OTHER CORRIDORS OF LAND WITH POTENTIAL FOR RECREATIONAL ROUTES WILL ONLY BE PERMITTED WHERE:-

- a) **AN ACCEPTABLE ACCESS CORRIDOR ALONG THE ORIGINAL ROUTE IS RETAINED, OR**
- b) **A SUITABLE DIRECT ALTERNATIVE ROUTE IS PROVIDED.**

- 8.46 Recreational routes provide important linear open space links within and between urban areas and the countryside, providing safer alternatives to roads for pedestrians, cyclists and horse riders. Existing routes will be safeguarded to ensure the retention of these valuable community resources.

- 8.47 Opportunities exist in Ashfield to create new recreational routes, particularly along disused railway tracks and alongside rivers or watercourses. The Pleasley/Teversal Trails indicate what can be achieved and recent colliery closures offer the opportunity to significantly expand the recreational route network using former railway connections to colliery sites. The former colliery branch railway lines linking Brierley Forest Park and the former Silverhill Colliery present an excellent opportunity to further develop this network linking to the Teversal Trails. The interruption by development of corridors of land with value as potential recreational routes will not generally be permitted. Where development likely to affect such routes is considered acceptable under other policies in this Local Plan, provision should be made to retain adequate through-access along the original route or for a suitable direct alternative route.

- 8.48 The need to improve pedestrian and cycle access to the Mill Lakes Country Park at Hucknall is recognised, as is the need to safeguard a pedestrian and cycle route through the Leen Valley itself. This is being pursued through the Corridors to the Countryside project. Such a link will ultimately provide a long-distance path from the City of Nottingham to Newstead Abbey to the north. The possibility of establishing a long distance route via the Erewash Valley has long been recognised. Greenwood Community Forest schemes will also provide opportunities to create new recreational routes for walkers, cyclists and horse riders.

SPECIALIST PURSUITS

- 8.49 Activities such as clay pigeon shooting, jet skiing, motorsports, paintball and war games can result in disturbance to adjoining uses particularly where these are noise-sensitive uses such as housing, schools and hospitals. It is anticipated that the growing demand for these uses, allied with the continuing pressure for rural diversification, will increase proposals, particularly in the countryside. Where possible these uses should take place on existing noisy sites, for instance adjoining industrial areas, or where physical barriers provide natural noise attenuation. Proposals for such uses will be considered in the context of policy ST1 with regard to their impact on adjoining and other nearby areas and more generally against other policies concerned with protecting the environment. Where there could be intrusive effects on noise-sensitive development or land uses, planning conditions may be used to restrict the hours/days of operation of the activity and require measures to reduce the effect of noise to an acceptable level.

TOURISM

- 8.50 Tourism can bring both employment and financial benefits to an area. Development associated with tourism will assist in the diversification of the local economy through the creation of new jobs. Ashfield has potential in a number of unexploited areas of its heritage. These include –
- a) religious heritage: - a number of fine churches exist,
 - b) industrial heritage: - coal-mining; textiles - including parts of the Leen Valley cotton mills; engineering - particularly Rolls Royce; railways, and
 - c) cultural heritage: - the association of Lord Byron and Eric Coates with the town of Hucknall.
- 8.51 Ashfield lies at the heart of the Greenwood Community Forest which will assist in its promotion to tourists and in particular day visitors. The District supports a number of existing and developing country parks, including Brierley Forest Park at Sutton-in-Ashfield, and an excellent and developing rights of way and recreational trails network. These include the Sustrans national cycle route which passes through Hucknall and paths on former railway lines and along river corridors. Projects linked to the development of the Greenwood Community Forest and promotion of the heritage of the District will continue to be pursued to promote Ashfield as a place to visit.
- 8.52 Pressure for tourist-related development, such as hotels and other forms of accommodation, craft and information centres and other attractions may occur on land outside the Main Urban Areas and Named Settlements. In addition to the usual development criteria contained in policy ST1, relating to traffic generation and impact on the environment, proposals in the rural areas will need to conform with Green Belt or Countryside policies EV1 and EV2. It is recognised that there is a shortfall of overnight hotel accommodation in Ashfield both to serve the needs of the business community and tourists visiting the area. Planning permission exists for hotel accommodation at Cauldwell Road, near to Sutton-in-Ashfield (also including a conference centre and golf course) and at Annesley Hall and the Sherwood Business Park both of which lie adjacent to the A608 and near to junction 27 of the M1. The economic and promotional benefits that arise from this type of development will be a material consideration in the determination of any proposals.

COMMUNITY SERVICES

POLICY RC9 DEVELOPMENT FOR ALTERNATIVE USES OF SITES REQUIRED FOR EDUCATIONAL, SOCIAL, HEALTH, COMMUNITY AND RELIGIOUS FACILITIES WILL NOT BE PERMITTED UNLESS ADEQUATE REPLACEMENT PROVISION IS MADE OR THERE IS NO LONGER A NEED FOR THE FACILITY.

- 8.53 The provision of a full range of community services is of importance to the social and economic well-being of Ashfield residents. Community services are taken to include facilities for education, churches, community centres, medical centres and uses associated with statutory undertakers and emergency services. The majority of these services are provided by other agencies such as the County Council and Health Authorities.
- 8.54 The Authority has consulted all community service providers as part of the preparation of this Plan to establish any requirements to safeguard land or make other provision for services. In respect of the South Notts. Sub Area in particular, detailed discussions have been carried out with Nottinghamshire County Council and Nottingham Health Authority concerning the provision of school and medical facilities in Hucknall due to the scale of development proposed and the potential impact on these services. Potential requirements at Hucknall generated by development outside of Ashfield in Gedling have also been considered.
- 8.55 Detailed discussions have taken place with Nottinghamshire County Council concerning the potential requirement for improvements to school provision as a result of proposed new housing development in the District and in particular in Hucknall. An assessment of likely future school capacity and demands for places deriving from new housing has been carried out by the County Council which has indicated requirements in particular areas of the District for additional

educational provision for primary and secondary schools. Contributions towards such facilities will be required from particular housing sites to reflect their scale and location. In Hucknall land should be safeguarded for a new primary school on a 1.1 hectare site on the Papplewick Lane Housing site HG1Ho. Contributions will also be negotiated in respect of this site towards the provision of a new 120 classroom primary school on the safeguarded land and towards new secondary school accommodation as appropriate. Contributions are also likely to be required in Hucknall towards additional school accommodation as appropriate at the two existing secondary schools and junior and infant schools, particularly at Broomhill Road, from the housing sites at East of Nottingham Road (HG1 Ha), Broomhill Farm (HG1 Hb), Lime Tree Avenue (HG1 Hc), Garden Road (HG1 Hj) and Papplewick Lane (HG1 Ho). In Kirkby-in-Ashfield contributions are likely to be required towards provision of additional primary accommodation from the Lindleys Lane housing site (HG1Ka). References have been made to reflect the above requirements in the briefs in Appendix 6 for each of these housing sites. These requirements will need to be further assessed at the time of any planning application to consider any changes in local circumstances. Any contributions towards new educational provision negotiated as part of the housing proposals will be secured through policy HG1. Any contributions required will reflect the scale of the housing site and take into account requirements for the site to contribute to other essential facilities as outlined in paragraph 5.21

- 8.56 In respect of medical facilities it is recognised that there are likely to be difficulties in providing medical services in Hucknall without additional practising doctors. Land has not however been safeguarded following agreement that the Council will work closely with Nottingham Health Authority to identify a site for a doctors practice in an appropriate location within or close to Hucknall town centre. This will ensure maximum flexibility in identifying a site which meets the requirements of doctors and the Health Authority.
- 8.57 The provision of any proposed new facilities and services should be well-related and easily accessible to the community they serve. This will enable safe and easy access by foot, public transport or car. Where sites for facilities have been identified, planning permission will not be granted for alternative uses unless it can be demonstrated that either the facilities are no longer needed or that alternative acceptable sites can be provided.

CHAPTER 9: IMPLEMENTATION

INTRODUCTION

- 9.1 Policies in the Local Plan can be broadly described as either:-
- a) development control policies or
 - b) proposals or "promotional" type policies involving practical implementation.

DEVELOPMENT CONTROL POLICIES

- 9.2 Development control policies comprise those policies that are intended to provide positive guidance for developers which the District Council will use to determine planning applications and restrict development where appropriate. The implementation of these policies will involve the Council consulting with, and seeking the advice of, various statutory authorities including The Highways Agency (on trunk road related matters), County Highways and other infrastructure providers such as water, gas and electricity companies, conservation and heritage bodies and other interested parties. The District Council may also, through the granting of planning permission, use planning conditions and planning obligations to secure the provision of improvements related to the development that might, for instance, require a developer to provide open space, social housing, roads, cyclepaths, public transport or other infrastructure considered necessary. The Authority has also prepared separate Supplementary Planning Guidance to guide developers on the design and implementation of their schemes. Development briefs, which may be prepared by the Council for individual housing, employment, shopping or recreation sites, will also aim to provide guidance to developers and infrastructure providers on what will be required as part of a development.
- 9.3 In the determination of any planning application, the Council will consider the level of any potential harm to interests of acknowledged importance. Development will be refused where any adverse impact reaches an unacceptable level. In reaching a decision the Council will weigh in the balance any potential benefits that will be provided by the development proposal.
- 9.4 The following policies can broadly be described as development control policies for the purposes of implementation: ST1-ST4, EV1-EV14, EV16-EV17, EM3-EM8, HG2, HG3, HG5, HG7-HG9, TR2, TR3, SH3-SH10, RC2, RC3, RC5, RC7 and RC9.

PROMOTIONAL POLICIES

- 9.5 Promotional (or proposal) policies in the Local Plan require or involve some form of practical action either by the District Council itself or by other bodies, particularly the private sector. These policies will provide guidance and incentive for the private sector through the allocation of appropriate sites for development for employment, housing, shopping and recreational purposes. They will also give infrastructure providers guidance to allow them to plan for new roads and other utilities such as gas, electricity, drainage and water supplies. Briefs for employment and housing sites in Appendices 4 and 6 provide additional detailed guidance on requirements in respect of specific development sites.
- 9.6 In many instances it will be possible for the District Council to work with the private sector to implement development schemes. This might for instance involve the Council developing industrial units or reclaiming derelict land for subsequent sale and private development or providing land for Registered Social Landlords to build affordable housing. In addition to the private sector, the District Council will continue to work closely with the County Council and other groups such as Groundwork Ashfield/Mansfield, Greenwood Forest Team and other conservation/environmental groups to undertake environmental improvements to the area. This will include the reclamation and restoration of derelict land, tree planting, hard and soft landscaping and the provision of recreational opportunities such as community routeways for walkers, cyclists and horse riders.
- 9.7 Many of the promotional policies may require, or result in the Council or other private sector interests, securing grants to enable development to proceed. The Council has been successful in

attracting a range of grants from the European Community and English Partnerships to assist in the preparation of land for development. Grants have also been attracted for economic and community development schemes from the Rural Development Commission and for environmental and recreational improvement schemes from the Forestry Authority and Countryside Commission. The District Council will continue to pursue grant assistance where appropriate and encourage other public and private sector groups to apply for grants to assist in the promotion and development of sites provided for in the Local Plan.

POLICY IMPLEMENTATION MATRIX

9.8 The matrix opposite identifies the primary agencies involved with the implementation of promotional policies in the Local Plan. Where an agency will, or is likely to, be involved in some way with the positive implementation of the policy on the ground through the provision of land, finance, manpower or other tangible resources, a mark is made in the relevant policy box. The private sector should be taken to include those main private agencies not specifically mentioned in the matrix such as housebuilders and developers of industrial land and premises and retailing facilities. Utility operators include gas, electricity, water and drainage agencies. Community service providers include educational, social, health and religious agencies. The matrix is intended to provide an "at a glance" picture of the general involvement of agencies in implementation that result from the positive guidance and incentives provided by the Local Plan. In practice, however, development on the ground is likely to be more complex and may involve more agencies than indicated in the matrix.

AGENCY	EV15	EM1	EM2	HG1	HG4	HG6	TR1	TR4	TR5	TR6	SH1	SH2	RC1	RC4	RC6
Ashfield D.C.	X	X	X	X	X	X	X	X	.	X	X	.	.	.	X
Community Service Providers	.	.	.	X	X
English Partnerships	X	X	.	X
GOEM/EMDA	X	.	X
Groundwork Ashfield/Mansfield	X
Registered Social Landlords	.	.	.	X	X	X	X
Nottingham City Council	X	X	X	X	X	.	X	X	.
Nottinghamshire County Council	X	X	X	X	X	.	X	X	X	X	X	.	X	X	.
Private Sector	X	X	X	X	X	X	X	X	.	X	X	X	X	X	X
Private Transport Operators	X	X	.	X	X
Rural Development Agency	.	X

Development Control Policies are excluded from this table

APPENDIX 1: LIST OF SITES OF IMPORTANCE FOR NATURE CONSERVATION (SINCS) (SEE POLICY EV6)

TYPE B – BIOLOGICAL SITES
TYPE G – GEOLOGICAL SITES

LP Ref	Name	Type	Description	Grid Ref.	County Ref.
1	Bulwell Wood and Pond, Hucknall	B	An ancient deciduous woodland with a characteristic ground flora, together with a valuable clean water pool, a small pond and a scrubby green lane	SK 518463	1/030
2	Bleinham Lane Pond, Bulwell	B	Species-rich pools surrounded by a noteworthy grassland and newly planted saplings	SK 521463	2/227
3	Farleys Disused Railway	B	A valuable wooded and scrubby habitat with a most interesting species	SK539471	2/235
4	Mill Lakes Swamp, Bestwood	B	A valuable tall swamp habitat	SK 547474	2/232
5	Mill Lakes Pasture, Bestwood	B	A valuable damp riverside pasture	SK 546474	2/233
6	Mill Lakes, Bestwood Country Park	B	A landscaped lake with a good range of species	SK 549480	2/231
7	River Leen Pastures, Bestwood	B	Fine pastures with an unusual and valuable species composition – including a representative length of the River Leen	SK 550487	1/116
8	Papplewick Ponds	B	Interesting subsidence ponds with some valuable peripheral habitats	SK 550473	2/074
9	Long Hill Meadow	B	A damp species-rich meadow	SK 521492	2/155
10	Misk Hill Meadow	B	A sloping meadow with an interesting array of noteworthy species	SK 505495	2/224
11	Dob Park Grasslands	B	Pastures incorporating some notable marshy areas	SK 523496	2/223
12	Washdyke Lane Hedges	B	Shrub-rich hedges	SK 523499	2/222
13	Hedges, Hayden Lane, Hucknall	B	Old hedges with a good selection of shrub and tree species	SK 538506	2/239
14	Wighay Wood	B	A mixed woodland that retains some interest	SK 516510	2/085
15	Annesley Park Duck Decoy	B	A lake with noteworthy flora, together with a mostly naturally regenerated woodland	SK 513514	2/084
16	Heatherdale Pond	B	A valuable habitat mosaic of woodland, scrub and acidic grassland	SK 510551	2/219
17	Morning Springs	B	A coniferous plantation with deciduous areas and species-rich pockets	SK 495497	2/008
18	Beauvale Brook	G	An exposure of Middle Coal Measures mudstones, siltstones and shales with fossils	SK 485499	2/1019
19	Felley Mill Pond	B	A drying pool with woodland and damp grassland	SK 486501	2/018
20	Weavers Lane Verge	B	Notable calcareous communities adjacent to a track	SK 492507	2/209
21	Felley Dumble	B	A good habitat mosaic of woodland, scrub, stream and pond with noteworthy flora	SK 498506	2/024
22	William Wood Drain	B	A notable herb assemblage along a fenced drain	SK 490510	2/210
23	Oak Plantation, Annesley	B	An interesting woodland with a noteworthy ground flora	SK 499516	2/218
24	Felley Priory Pond	B	A pond with notable aquatic and bankside flora	SK 485512	2/150
25	Underwood Football Ground	B	A little used football pitch flanked by notable damp areas	SK 479510	2/197
26	Friezeland Grassland	B	Species-rich pools, flushes and grassland developed in former quarry	SK 476506	1/007
27	Grassland (II), Selston	B	A notable grassland community	SK 467499	2/168
28	Grassland (I), Selston	B	A little managed, species rich grassland	SK 467498	2/167
29	Underwood Pastures	B	Grasslands with noteworthy sward	SK 472510	2/023
30	Underwood Meadows	B	Herb-rich meadows with an especially important stream	SK 470510	2/175
31	Grassland, Bagthorpe	B	A grassland with an impressive herb and grass content	SK 464513	2/166
32	Bagthorpe Pastures	B	Notable pastures with an especially valuable stream	SK 472513	2/174
33	School Road Pasture, Bagthorpe	B	An interesting pasture and stream, showing an excellent species-diversity	SK 469515	2/176

LP Ref	Name	Type	Description	Grid Ref.	County Ref.
34	Bagthorpe Grasslands	B	Traditionally managed grasslands with a rich and varied botanical interest	SK 470518	1/133
35	Middlebrook Meadow	B	A classic Coal Measures type community	SK 477518	1/114
36	Middlebrook Grassland	B	A good species-rich example of a Coal Measures type grassland	SK 478518	2/195
37	Millington Springs Grassland	B	A good species-rich example of a damp Coal Measures type grassland	SK 481520	2/196
38	Middle Brook	B	A stream with good riparian woodland and notable bankside communities	SK 479520	2/019
39	Annesley Park Pond	B	A relatively large field pond that is rich in aquatic and marginal species	SK 504521	2/217
40	Davis's Bottom Grassland	B	A grassland with notable species assemblage	SK 492524	2/212
41	Davis's Bottom	B	A valuable woodland with a notable ground flora	SK 493527	2/213
42	Davis's Bottom Pasture	B	Two through grazed grasslands with excellent herb-rich sward showing calcareous and Coal Measures influence	SK 490527	1/108
43	Selston Common Grasslands	B	A classic Coal Measures type community	SK 477518	1/130
44	Holly Hill, Selston	B	An interesting area of scrub with acidic grassland	SK 473529	2/194
45	Allens Green Grassland	B	A locally species-rich Coal Measures grassland	SK 465524	2/177
46	Home Farm Grassland, Selston	B	A species-rich, Coal Measures grassland	SK 464523	2/178
47	Home Farm Bank, Selston	B	A grassy bank supporting a good Coal Measures type community	SK 462521	2/017
48	Meadow, Brinsley	B	A hay meadow with a characteristic and noteworthy sward	SK 460521	2/169
49	Pye Hill Marshy Grassland	B	An interesting marshy field with locally characteristic grassland species	SK 443515	2/348
50	Pye Hill Pastures	B	A herb-rich pasture with scattered shrubs	SK 440523	2/163
51	Erewash Pye Pastures	B	Cattle grazed grasslands with a notable herb content along an unaltered length of the River Erewash	SK 445530	2/165
52	River Erewash, Selston	B	A natural, meandering length of the River Erewash providing a number of valuable habitats	SK 446535	2/351
53	Erewash Grasslands, Selston	B	A species-rich grassland with a meandering stretch of the River Erewash	SK 447537	2/164
54	Rosemary Hill Pastures	B	Notable pastures with a basic influence	SK 465532	2/149
55	Hall Green Grassland	B	A classic coal Measures grassland	SK 463541	1/049
56	Bogs Farm Quarry	B	Species-rich pools, flushes and grassland developed in a former quarry	SK 482534	1/006
57	Two Dales Farm Pasture, Annesley	B	A notable pasture with damp and dry parts	SK 489531	2/216
58	Annesley Woodhouse Quarry	G	An old quarry face exposing a good clear section of Lower Magnesian Limestone which exhibits marl lenses, cross bedding and other sedimentary features	SK 491533	2/1013
59	Annesley Woodhouse Quarry	B	An excellent Magnesian Limestone grassland	SK 489533	1/008
60	Wharf Yard Bank, Kirkby Woodhouse	B	A herb-rich, calcareous bank	SK 489543	2/214
61	Kirkby Woodhouse Bank	B	A steep bank clothed in ruderal vegetation with a notable calcareous community	SK 490544	2/215
62	Langton Marshy Grasslands	B	Interesting marsh, swamp and damp grasslands - of both botanical and zoological interest	SK 471548	2/179
63	Langton Meadow	B	A notable Coal Measures grassland	SK 474549	2/180
64	Kirkby Woodhouse Limestone Grassland	B	A species-rich calcareous bank	SK 493546	1/005

LP Ref	Name	Type	Description	Grid Ref.	County Ref.
65	Hollinwell Golf Course	B	An extensive area incorporating a number of acidic habitat types with their characteristic species	SK 524547	2/225
66	Halfmoon Mosaic. Kirkby-in-Ashfield	B	A valuable habitat mosaic of woodland, scrub, and acidic grassland	SK 510551	2/220
67)	Kirkby Grives	B	Very fine examples of calcareous and more neutral grassland, with scrub and floristically species-rich woodland	SK498554	1/009
	Kirkby Grives (Portland Park)	G	Exposures of Lower Magnesian Limestone showing good cross-bedding	SK499553	2/1015
68	Grassland, Kirkby Grives	B	A rough damp notable grassland	SK493552	2/016
69	Kirkby Grives (I)	B	Very fine examples of calcareous and more neutral grassland, with scrub and floristically species-rich woodland	SK 498554	1/010
70	Pinxton Road Grasslands, Kirkby	B	A group of species rich grasslands	SK 484553	2/202
71	Pinxton Lane Verge	B	A roadside verge supporting an interesting flora	SK 480556	2/203
72	Springfield Cottage Grasslands	B	A fine series of little-improved, species-rich grassland	SK 487557	2/201
73	Boar Hill	B	A bank of calcareous grassland	SK 483562	2/205
74	Maghole Brook and Ashfield Dumble	B	A stream and dumble with their associated woodland and sections of interesting ground flora	SK 469563	2/022
75	Mawkin Lane	B	A green path with a notable community	SK 469561	2/204
76	Franderground Farm Disused Railway	B	A wooded disused railway with a notable flora	SK 473563	2/152
	Pinxton Lane Railway Cutting	G	A rare exposure of oil rich shales from Middle Coal Measures	SK 473563	2/1014
77	Ashfield By-pass Meadows	B	Herb-rich meadows	SK 482574	2/200
78	New Hucknall Disused Railways	B	A valuable length of disused railways with a notable, characteristic community	SK 464575	2/181
79	Coxmoor Golf Course	B	An excellent habitat mosaic with a most impressive flora	SK 526575	1/036
80	Thieves Wood Ex	B	An extensive coniferous plantation with ancient deciduous portions and an interesting flora and fauna	SK 544567	2/078
81	Harlow Wood Ex	B	An extensive coniferous plantation with a noteworthy flora	SK 554571	2/079
82	Stonehills Plantation Ride	B	A notable acidic grassland	SK 533581	2/230
83	Cauldwell Dam and Drain	B	A pond, marsh and drain with a noteworthy community	SK 530583	2/080
84	Sutton Quarry	G	An exposure showing the Lenton Sandstone Formation and the Nottingham Castle Formation with faulting	SK 518585	2/1012
85	Fulwood Grassland	B	A neglected species-rich grassland	SK 476579	2/182
86	Kings Mill Reservoir	B	A valuable water body for flora and fauna	SK 516595	2/226
87	Blackwell Road Grassland	B	A notable dry grassland community	SK 459590	2/1003
88	Sunnyside Farm Meadows	B	A fine sequence of variously wet and dry grasslands	SK 463591	1/109
89	Chesterfield Road Pastures, Huthwaite	B	A network of four grazed pastures with an impressive diversity of community types	SK 463595	1/110
90	Spring Farm Pasture, Huthwaite	B	A long established and notably species-rich grassland community	SK 457591	1/111
91	Spring Farm Meadows, Huthwaite	B	A sequence a species-rich hay meadows	SK 457592	2/959
92	Grassland, Huthwaite	B	A noteworthy meadow with both dry, acidic and neutral grassland communities represented within its herb-rich sward	SK 461594	2/148
93	Strawberry Bank Meadow	B	A species-rich hay meadow	SK 460596	2/960
94	Border Marsh, Huthwaite	B	A notable marshy community on the county border	SK 456598	2/527
95	Huthwaite Park Marshy Grassland	B	An interesting and valuable remnant of rough marshy grassland	SK 474595	2/191

LP Ref	Name	Type	Description	Grid Ref.	County Ref.
96	Grassland, Sutton-in-Ashfield	B	A species-rich grassland with damp and dry parts	SK 481595	2/190
97	Stubbinghill Farm Meadow	B	A notable meadow with a particularly valuable sloping portion	SK 477601	2/153
98	Herods Hill Grasslands	B	Well-established, species-rich pastures	SK 465601	2/029
99	Whiteborough Railway	B	An interesting stretch of active railway with a grassland community of particular note	SK 461601	2/173
100	City of Whiteborough Station	G	An exposure of Middle Coal Measures marls, mudstones and siltstones	SK 459601	2/1016
101	Whiteborough Farm Pasture	B	A well-established pasture with a notable plant community	SK 459604	2/172
102	Grasslands, Stanton Hill	B	Grasslands with a number of notable species	SK 492605	2/189
103}	Skegby Railway Cutting	G	A good exposure of Lower Magnesian Limestone	SK 495607	2/1018
	Skegby to Pleasley Railway	B	A range of habitats developed on a disused railway, including some excellent species rich grassland - also of zoological interest	SK 492620	1/012
104	Stanton Hill Road Cutting	G	An exposure revealing the junction of Lower Permian Marl and Lower Magnesian Limestone	SK482608	2/1017
105	Skegby Junction Meadow	B	A valuable wet meadow	SK 495614	2/033
106	Pasture, Skegby	B	A grassland with a valuable collection of herbs	SK 492615	2/206
107	Skegby Railway Grassland	B	A grassland with an impressive herb content	SK 488614	1/115
108	Cricket Pitch Grassland	B	A herb rich grassland	SK 481614	2/207
109	Tiversal Pastures	B	Excellent neutral grasslands with marsh and flushed woodland - of botanical and zoological interest	SK 494616	1/016
110	Meadow, Skegby	B	A valuable wet meadow	SK 494616	2/032
111}	Tiversal to Pleasley Railway	B	A range of habitats, with especially valuable calcareous grassland, along a length of railway	SK 486633	1/011
	Tiversal Disused Railway	B	An interesting stretch of disused railway with a particularly notable calcicolous community	SK 480625	2/193
112	Newboundmill and Blackholme Woods	B	Wet species-rich deciduous woodland	SK 492635	1/013
113	Silverhill Lane	B	An attractive cutting with tall, botanically interesting, hedgebanks	SK 463621	2/709
114	Stanley Farm Grasslands	B	Species-rich Coal Measures grasslands along a tree lined stream	SK 464624	1/015
115	Crossley Plantation	B	A mature neglected plantation site with a very rich ground flora	SK 470629	1/102
116	Dovedale Wood Grassland	B	A floristically rich grassland with Coal Measures indicator species	SK 465629	2/027
117	Dovedale Wood	B	An ancient deciduous woodland	SK 466632	1/014
118	Dovedale Farm Field Bank	B	A very species rich bank	SK 471631	2/030
119	Lady Spencers Wood	B	Deciduous woodland with a noteworthy ground flora	SK 470633	2/026
120	Norwood Plantation	B	A sizeable deciduous woodland containing a scrambling course and some noteworthy species	SK 480634	2/028
121	New Hucknall Sidings Grassland	B	Grassland with Notable Species	SK 464581	2/146
122	New Hucknall Disused Railways	B	Notable Characteristic Community	SK 464576	2/181
123	Rookery Lane Grassland, Fulwood	B	Neglected Species-rich Grassland	SK 476579	2/183
124	Huthwaite Commonsides Industrial Estate	B	Grassland and Meadow Community	SK 461584	2/186
125	Huthwaite Commonsides Industrial Estate	B	Grassland and Meadow Community	SK 465584	2/187
126	Kirkby Wasteland	B	Neglected Grassland	SK504570	2/221
127	Bentinck Void	B			

**APPENDIX 2 : LIST OF ANCIENT WOODLAND SITES
(SEE POLICY EV8)**

LP Ref	Name	Grid Ref.
EV8/1	Bulwell Wood	SK 518463
EV8/2	Morning Springs	SK 493497
EV8/3	Park Springs	SK 499501
EV8/4	Millington Springs	SK 483522
EV8/5	The Dumbles	SK 475567
EV8/6	Healds Wood	SK 487613
EV8/7	Dawgates Wood	SK 495618
EV8/8	Dovedale Wood	SK 466631
EV8/9	Norwood	SK 479636

**LIST OF BUILDINGS OF SPECIAL ARCHITECTURAL OR HISTORIC INTEREST
SEE POLICY EV12**

Hucknall	Grade
Church of St. Mary Magdalene, Market Place	II*
Hucknall Library, Market Place	II
Houses of Rest for Miners, Park Drive	II
Boundary Wall and Gates at Houses of Rest for Miners, Park Drive	II
Hucknall War Memorial, off Park Drive	II
Memorial Drinking Fountain, Titchfield Park, off Park Drive	II
No. 204 Beardall Street	II
Nos. 71 & 73 Nottingham Road	II
Hangars 1 & 2 at K & M Hauliers, Watnall Road	II
Hangars 3 & 4 at K & M Hauliers, Watnall Road	II
Master Hosier's House and attached Workshop, Albert Street, Hucknall	II
Kirkby-in-Ashfield	
Nos. 12-16 (even) Chapel Street, Farmhouse and adjoining Cottage	II
Barn and Stables at Nos. 12-16 (even) Chapel Street	II
Farmyard and Garden Walls at Nos. 12-16 (even) Chapel Street	II
No. 20 Chapel Street	II
Garden Boundary Wall to west of No. 20 Chapel Street	II
Stable adjoining No. 20 Chapel Street to north-east	II
Stable Range 20m. east of No. 20 Chapel Street	II
K6 Telephone Kiosk adj. Stable Range to the east of No. 20 Chapel Street	II
The Post Office, Church Street	II
No. 2 and No. 6 and adjoining Stable, Church Street	II
Kirkby Cross, Church Street	II
The Old Rectory, Church Street	II
No. 13 (The Croft) Church Street	II
Well Head, 7m. east of No. 13 Church Street	II
Pinfold, Church Hill	II
War Memorial and Boundary Wall, Kingsway	II
Prospect Farmhouse and adj. Walls, Main Road, Kirkby Woodhouse	II
Sutton-in-Ashfield	
No. 215 Mansfield Road	II
Skegby Pinfold, Mansfield Road	II
Skegby Manor House, Mansfield Road	II
Church of St. Andrews, Mansfield Road, Skegby	II
Fulwood Farmhouse, Alfreton Road	II
Church of St. Mary Magdalene, Church Avenue	II
Headstone 15m. south-east of South Porch of Church of St. Mary Magdalene, Church Avenue	II
No. 47 (Hunters Bar) Church Street	II
The Manor House, Devonshire Square	II
The Old Blue Bell, Devonshire Square	II
United Reformed Church, High Pavement	II
Sutton War Memorial, Huthwaite Road	II
Unwin's Mill, Lucknow Drive	II
Unwin's Mill House and adj. Outbuildings, Lucknow Drive	II
The Windmill, Prospect Place	II
No. 16 Main Street, Huthwaite	II
Huthwaite War Memorial, Sutton Road, Huthwaite	II

Named Settlements and Rural Areas	Grade
Church of St. Helen, Church Lane, Selston	II*
No. 49 Station Road, (Dog Kennel Farmhouse), Selston	II
Church of St. Michael and All Angels, Church Lane, Underwood	II
Lychgate at Church of St. Michael, Church Lane, Underwood	II
Remains of Wansley Hall, Wansley Hill, Bagthorpe	II
Manor Farmhouse, Wansley Lane, Bagthorpe	II
Barn 50m. east of Wansley Hall, Wansley Hill, Bagthorpe	II
Forge Mill, Mill Lane, Hucknall	II
Nos. 40-45 (inclusive) (Grange Cottages) Moor Road, Hucknall	II
Church of St. Wilfrid, Church Street, Kirkby-in-Ashfield	II
Annesley Hall, Annesley Park, Annesley	II
Terrace to south-west of Annesley Hall, Annesley Park	II
Ruins of Church of All Saints, Annesley Park	I
Gatehouse Range at Annesley Hall, Annesley Park	II
Gate Pier at South Lodge, Annesley Hall, Annesley Park	II
Church of All Saints, Church Drive, Annesley	II*
Annesley Lodge, Mansfield Road, Annesley	II
Felley Priory with adjoining Garden Wall, Buttery Lane Teversal	II
Stables and Barns at Felley Priory, off Mansfield Road, Annesley	II
Felley Cottage, off Mansfield Road, Annesley	II
Church of St. Katherine, Buttery Lane, Teversal	I
Teversal Farmhouse, Buttery Lane, Teversal	II
The Privets, Buttery Lane, Teversal	II
School House Cottage and adj. Manor Room, Buttery Lane, Teversal	II
The Old Rectory and adjoining Garden Wall, Buttery Lane, Teversal	II
The Coachhouse Stable to north of the Old Rectory, Buttery Lane, Teversal	II
Teversal Manor, Buttery Lane, Teversal	II
Garages to north-east of Teversal Manor	II
Walled Terrace Gardens with Steps and Gatepiers, to south of Teversal Manor, Buttery Lane, Teversal	II
Kruck Cottage, Low Road, Skegby	II
Skegby Hall, Mansfield Road, Skegby	II
Manor Farmhouse, Dawgates Lane, Skegby	II
Norwood Lodge, Newbound Lane	II
Dalestorth House and adj. Service Wing and Garden Boundary Walls, Skegby Lane, Sutton-in-Ashfield	II

EMPLOYMENT SITE BRIEF E1

POLICY REF: **EM1 Sa**

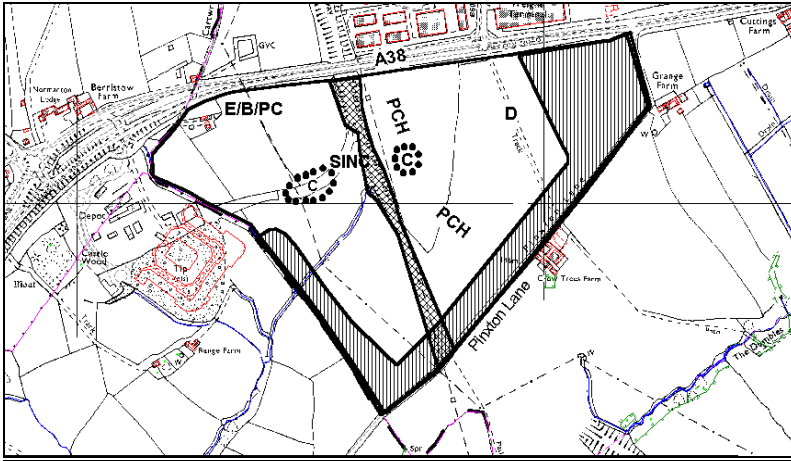

SITE NAME: **Pinxton Lane,
Sutton-in-
Ashfield**

GROSS
SITE AREA: 44.2 Ha

Reproduced from the Ordnance Survey mapping with the permission of the controller of Her Majesty's Stationery Office Crown Copyright. Unauthorised reproduction infringes on Crown Copyright and may lead to prosecution or civil proceedings

- A. STRATEGIC/LOCATION**
1. This site is well located to take advantage of the excellent links via the A38 to the M1. A regular bus service and footpaths/cycleways also exist on the A38 which could be readily utilised to maximise non car access to the site.
- B. ENVIRONMENT**
1. The Site of Interest for Nature Conservation (SINC) is centrally located on the site at the former railway line. This should be retained within any development proposal. An appropriate landscaped buffer zone should be established either side of the SINC site. A landscaped corridor of similar width, incorporating the proposed trail referred to in Section C, part 7 below, should be continued from the SINC site to Pinxton Lane.
 2. Existing trees and hedges should be protected where possible and in particular on external site boundaries.
 3. Major structural tree planting using native species will be required on higher ground to the east of the site and on the southern and south western site boundaries to minimise visual intrusion.
 4. The design and layout of any scheme will be required to avoid any adverse impacts on watercourses. Any proposed water balancing area should be located adjacent to the nature conservation area in the centre of the site. This should be designed to enhance this nature conservation area.
 5. The Eastern limit of built development will be required to be identified in detail taking into account existing and proposed levels, proposed building design and in particular heights, existing and proposed, landscaping and subsequently an overall assessment of the visual impact of the proposal.
- C. TRANSPORT**
1. A detailed transport assessment will be required for this site which should include reference to the issues indicated below and any other on or off site requirements to provide a safe and convenient means of access to this site.
 2. Access to the site should be provided from the A38 for vehicles, including public transport, cyclists and pedestrians.
 3. Access from the site to the A38 should be combined with an improved Pinxton Lane as it meets the A38. The junction with the A38 would require upgrading and signals provided.
 4. Emergency access should be provided from the site to the access road serving the factory retail outlet centre to the west of the site. This should also include a cycle and pedestrian link.
 5. Design of the highway layout should facilitate bus access and turning. Ideally this should be through access utilising the emergency access referred to in 4 above.
 6. The layout of the site should be pedestrian and cycle friendly including links to adjoining routes. These routes may require upgrading, particularly the cycle route on the A38.
 7. A new landscaped path link for pedestrians, cyclists and horse riders should be established on the route of the old railway line which passes under the A38 and links to Pinxton Lane. The new route should link directly to the bridleway to the south of Pinxton Lane. Safe provision should be made for crossing the roads.
- D. SERVICES**
1. Possible off-site gas reinforcement required
 2. Overhead power lines may need relocating. Major new electricity infrastructure works will be required including a new sub-station
 3. Foul water will need to be taken to Common Road and a pumping station may be required.
 4. On site surface water balancing is likely to be required.
- E. OTHER**
1. Three potential areas of landfill are shown on the above plan. This will require further investigation to assess levels of contamination and identify any remedial measures required.
- 8. 8.** The bridleway to the east of the site may need relocating to coincide with the proposed tree planted area to provide a safe and attractive new route.
- 9. 9.** A 'Green Transport Plan' must be submitted with any planning application for this site to demonstrate how the integration of public transport, cycling and pedestrian provision in the development will minimise travel to work by car and parking requirements. Car parking provision should be made within the maximum Council standards. Improvements will be required to public transport in the area to ensure this site is served by buses. The level of non car based provision, i.e. bus, cycle and pedestrian access, may allow a negotiated reduction in parking provision.
- 10. 10.** Contributions towards transport improvements will be required in accordance with Local Plan Policy TR6.
- 11. 11.** Consultation will need to be undertaken with the Highways Agency regarding the need to contribute towards potential improvements to junction 28 of M1.

EMPLOYMENT SITE BRIEF E3

POLICY REF: **EM1 Rc**

SITE NAME: **Annesley Colliery**

GROSS SITE AREA: 9 Ha

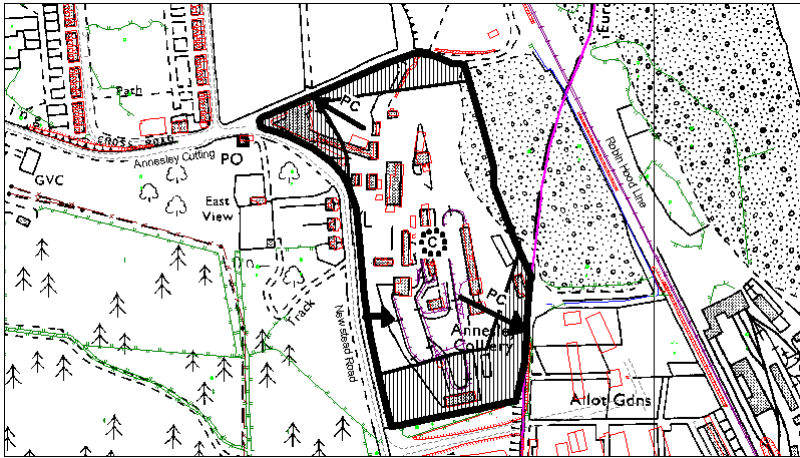

Plan reproduced from the Ordnance Survey mapping with the permission of the controller of Her Majesty's Stationery Office © Crown Copyright. Unauthorised reproduction infringes on Crown Copyright and may lead to prosecution or civil proceedings

A. STRATEGIC/LOCATION

1. This site is located in close proximity to the M1 with access via the A608. The Colliery site was closed in early 2000 and this allocation for employment use will assist in the redevelopment and re-use of a previously used ('brownfield') site.

B. ENVIRONMENT

1. The site itself has no identified landscape or wildlife interest. Adjacent land to the east and south has however been tree planted and landscaped in the recent past.
2. Substantial native tree planted buffers are proposed to the north and south of the site to integrate with existing planted areas to the east of this site to form a visual buffer to the site from surrounding opening countryside.
3. Site contamination from the Colliery use together with issues concerning gas emissions, water pollution, and minewater will need to be considered in conjunction with the relevant statutory authorities including the Environment Agency. Consequently a comprehensive approach to reclamation of the site for employment uses will be required.
4. This site lies within the recently designated New Annesley Conservation Area. A Survey will be required to establish if there are any buildings of historical value and worthy of retention. Consequently an assessment should be made of the most appropriate means to retain and re-use these buildings where possible.

C. TRANSPORT

1. Access to the site will be from Newstead Road in the vicinity of the existing access towards the southern end of the site.
2. Highway improvements are likely to be required at the junction of Annesley Cutting and the A611, Derby Road.
3. A pedestrian and cycleway link should be established north-south through the site with links to Hazelford Way to the south to facilitate improved access to the Robin Hood Line Station at Newstead and a link to Annesley Rows. This will improve an existing cycleway which currently follows Hucknall Road.
4. Contributions towards transport improvements will be required in accordance with Local Plan policy TR6.

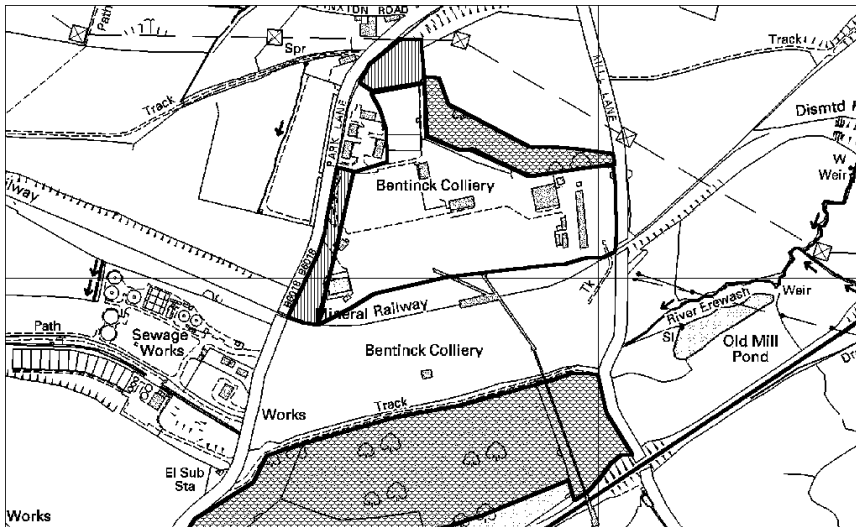
EMPLOYMENT SITE BRIEF E4POLICY REF: **EM1 Rd**SITE NAME: **Bentnck Colliery**GROSS SITE AREA: **6.5 Ha**

Reproduced from the Ordnance Survey mapping with the permission of the controller of Her Majesty's Stationery Office © Crown Copyright. Unauthorised reproduction infringes on Crown Copyright and may lead to prosecution or civil proceedings

A. STRATEGIC/LOCATION

1. This Colliery site was closed in early 2000 and this allocation for employment use will assist in the redevelopment and re-use of a previously used ('brownfield') site. The site also includes a rail head which could be potentially used for freight purposes.

B. ENVIRONMENT

1. The site itself comprises very little of landscape or wildlife value except for some hedgerows/trees on external site boundaries which should be retained where possible. Adjacent land to the north and south has been tree planted in the recent past.
2. Substantial landscape buffers using native tree species will be required as shown on the plan above, to minimise visual intrusion of the proposed employment area to the open countryside to the west. These should be integrated with existing tree planted areas.
3. Site contamination from the Colliery use together with issues concerning gas emissions, water pollution, and minewater will need to be considered in conjunction with the relevant statutory authorities including the Environment Agency. Consequently a comprehensive approach to reclamation of the site for employment uses will be required.

C. TRANSPORT

1. Access to the site will be from the existing site entrance off Park Lane.
2. The Colliery site presently utilises a freight rail head to transport coal. The potential for reusing this facility should be retained to encourage the potential use for non road freight transport.
3. Contributions towards transport improvements will be required in accordance with Local Plan policy TR6.

D. SERVICES

1. On site surface water balancing may be required.

EMPLOYMENT SITE BRIEF E5

POLICY REF: **EM1 Re**

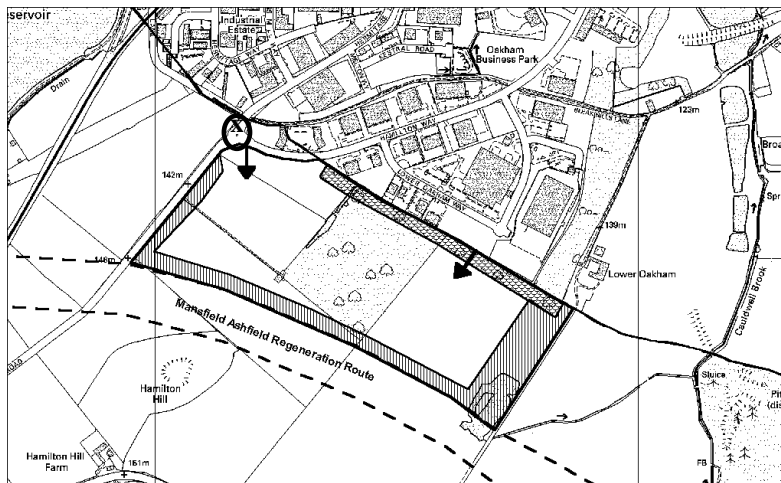

SITE NAME: South West Oakham Business Park, Sutton-in-Ashfield

GROSS SITE AREA: 27.5Ha

Plan reproduced from the Ordnance Survey mapping with the permission of the controller of Her Majesty's Stationery Office Crown Copyright. Unauthorised reproduction infringes on Crown Copyright and may lead to prosecution or civil proceedings

A. STRATEGIC/LOCATION

1. This site is well located to take advantage of links to the proposed Mansfield Ashfield Regeneration Route when constructed. The site will also benefit from existing infrastructure provided for the adjacent Oakham Business Park.

B. ENVIRONMENT

1. The site contains a number of trees and hedgerows and is located in close proximity to the Cauldwell Brook area of nature conservation value to the east.
2. Existing trees and hedgerows should be retained where possible and in particular on external site boundaries (including new tree planting to the northern site boundary).
3. A tree planted buffer zone should be established on the eastern, western and southern site boundaries to minimise visual intrusion particularly to the Cauldwell Brook and Kingsmill Reservoir areas and the open break between Sutton and Mansfield which includes Hamilton Hill.
4. The height of buildings on higher land to the north west of the site in particular will be controlled to minimise visual intrusion on surrounding land
5. All tree/shrub species to be native species.
6. The ponds located in the centre of this site should, if feasible, be protected and enhanced as part of any development proposal.
7. Any development scheme should be designed and constructed to avoid adverse effects to either watercourses or groundwater sources.

C. TRANSPORT

1. A detailed transport assessment will be required for this site which should include reference to the issues indicated below and any other on or off site requirements to provide a safe and convenient means of access to this site.
2. Access to the site should be from the existing spine road serving Oakham Business Park from Hamilton Road. This may require some off site highway improvements to the spine road and to Hamilton Road itself.
3. An option should be retained for potential future access to the Mansfield-Ashfield Regeneration Route at the south eastern corner of the site.
4. The design of any development should facilitate convenient bus access which could be integrated with any service provided for the adjoining Oakham Business Park.

5. Pedestrian and cycle access should be extended throughout this site, from adjoining provision at Oakham Business Park.
6. A 'Green Commuter Plan' must be submitted with any planning application for this site to demonstrate how the integration of public transport, cycling and pedestrian provision in the development will minimise travel to work by car and parking requirements.
6. Contributions towards transport improvements will be required in accordance with Local Plan policy TR6.

HOUSING LAND ALLOCATIONS**Sites in South Notts. Sub-Area**

Site Ref	Area	Total Site Area (Ha)	Gross Hsg Area (Ha)	Net Hsg Area (Ha)	Density (Dwgs/Ha)	Dwellings	
Hucknall							
HG1Ha	East of Nottingham Road	6.7	5.4	4.9	34	167	^
HG1Hb	Broomhill Farm	11.8	11.8	10.6	34	360	◆ ^
HG1Hc	Lime Tree Avenue/Farleys Lane	2.7	2.7	2.7	30	81	*
HG1Hd	Polperro Way	0.6	0.6	0.6	30	18	*
HG1He	High Leys Road	1.1	1.1	1.1	26	29	#
HG1Hf	Watnall Road	0.9	0.9	0.9	30	27	*
HG1Hh	Brickyard	0.7	0.7	0.7	34	24	*
HG1Hi	Portland Road (Former Hucknall Colliery)	5.1	5.1	5.1	40	205	*#
HG1Hj	Garden Road	7.0	7.0	6.3	34	214	^
HG1Hn	Former Co-op Site, Ogle Street	0.2	0.2	0.2	40	8	*
HG1Ho	South of Papplewick Lane	48.4	22.1	19.9	33	666	^*
HG1Hp	Linby Road	0.6	0.6	0.6	34	19	~*
HG1Hr	Holbeck Road/Linby Walk	0.9	0.9	0.9	34	31	*
HG1Ht	Park Drive	3.1	3.1	3.1	45	142	*#
HG1Hu	Byron Street	0.8	0.8	0.8	34	28	*
HG1Hv	Station Terrace	0.2	0.2	0.2	40	8	*
HG1Hw	Broomhill Court, Broomhill Road	0.2	0.2	0.2	56	10	#
Total Hucknall		91.0	63.4	58.8	35	2037	
Bestwood Village							
HG1Nj	Old Mill Close (East)	0.7	0.7	0.7	34	24	*
HG1Nk	Old Mill Close (West)	1.6	1.6	1.6	34	54	#
Total Bestwood		2.3	2.3	2.3	34	78	
TOTAL SOUTH NOTTS		93.3	65.7	61.1	35	2115	

KEY

- * Open space commuted sum required
- # Sites with planning permission at 30th November 2000
- \$ Likely to be capacity constrained by access
- ^ On-site open space required
- ~ Part of site has planning permission which is reflected in the density figure
- ◆ The total dwelling figure may be reduced to reflect the need to ensure that development is not visible over the spur in views from the south-west.

Please note:

- 1) Numbers may not sum due to rounding
- 2) Total dwellings identified for each Sub-Area in Appendix 5 do not equal total dwellings for each area in Table 5.1 exactly, as previous LARGE SITE allocations now with less than 10 dwellings remaining are not included in policy HG1 and Appendix 5 as they are too small to allocate, but are included in Table 5.1.

Sites in West Notts. Sub-Area

Site Ref	Area	Total Site Area (Ha)	Gross Hsg Area (Ha)	Net Hsg Area (Ha)	Density (Dwgs/Ha)	Dwellings	
	Kirkby						
HG1Ka	Lindley's Lane	29.7	13.9	13.9	N/A	441	\$*
HG1Kd	Beech Avenue	0.7	0.7	0.7	30	21	*
HG1Kf	Occupation Lane	0.7	0.7	0.7	30	21	*
HG1Kh	Lane End	1.5	1.5	1.5	40	60	*#
HG1Ki	Diamond Avenue	2.1	2.1	2.1	34	71	*
HG1Kj	Edward Street/Ashwood Avenue	1.5	1.5	1.5	46	59	#
HG1Kk	Lowmoor Road/Marlborough Rd	0.7	0.7	0.7	33	23	#
HG1Kn	Cavendish Cres. Annesley W'house	1.4	1.4	1.4	30	42	*
HG1Ko	Cromford Road, Annesley W'house	0.5	0.5	0.5	30	15	*
HG1Kp	Main Road, Annesley W'house	2.2	1.7	1.7	30	51	*
HG1Kq	Skegby Road, Annesley W'house	1.7	1.7	1.7	30	50	*
HG1Kr	Birds Lane, Annesley W'house	2.6	2.6	2.6	30	78	*
	TOTAL KIRKBY	45.3	29.0	29.0	32	932	

Site Ref	Area	Total Site Area (Ha)	Gross Hsg Area (Ha)	Net Hsg Area (Ha)	Density (Dwgs/Ha)	Dwellings	
	Named Settlements						
	Selston						
HG1Na	Inkerman Street/Alma Road	0.9	0.9	0.9	25	23	#
HG1Ne	Manitoba Way	1.4	1.4	1.4	25	34	*#
HG1Ni	Alfreton Road	0.5	0.5	0.5	29	14	*#
	Jacksdale						
HG1Nf	Westdale Road/Rutland Road	0.9	0.9	0.9	30	27	*
HG1Ng	Westdale Road	2.1	2.1	1.9	30	57	^
	New Annesley						
HG1Ni	Moseley Road	0.8	0.8	0.8	42	35	#
	TOTAL NAMED SETTLEMENTS	6.6	6.6	6.4	30	190	
	Rural Area						
HG1Ra	Annesley Hall	3.8	3.8	1.5	8	12	#
HG1Rc	Harlow Wood-South	5.5	4.5	4.5	18	82	#
HG1Rd	Fackley Road, Teversal	0.5	0.5	0.5	29	15	#
	TOTAL RURAL AREA	9.8	8.8	6.5	17	109	

Sites in West Notts. Sub-Area

Site Ref	Area	Total Site Area (Ha)	Gross Hsg Area (Ha)	Net Hsg Area (Ha)	Density (Dwgs/Ha)	Dwellings	
	Sutton						
HG1Sa	Alfreton Road/Calladine Park	15.9	8.0	7.2	29	208	#
HG1Sb	Crowtrees Drive	0.4	0.4	0.4	33	13	#
HG1Sd	Calladine Park – central	2.6	2.6	2.6	32	73	#
HG1Se	Hillsborough Avenue	4.8	4.8	4.8	30	144	*
HG1Sf	Off The Avenue	0.7	0.7	0.7	34	24	*
HG1Sh	Alfreton Road South	1.4	1.4	1.4	30	42	*
HG1Si	Jephson Road	1.1	1.1	1.1	34	37	*
HG1Sj	Kirkby Folly Road	0.7	0.7	0.7	30	21	#
HG1Sl	Mowlands Close/Sheepwash Lane	3.1	3.1	2.8	30	84	^
HG1So	The Twitchell	0.4	0.4	0.4	40	16	*
HG1Sp	Stoney Street	0.9	0.9	0.9	40	36	*
HG1Sq	Carsic Lane/Davies Avenue	0.4	0.4	0.4	25	10	
HG1Sr	Ashford Rise	0.7	0.7	0.7	34	24	*
HG1Ss	Stoneyford Rd/Mount Pleasant	1.2	1.2	1.2	34	41	*
HG1Sx	Stoneyford Road	1.0	1.0	1.0	30	30	*
HG1Sy	North of Carsic Road	0.5	0.5	0.5	30	15	*
HG1Sab	Meden Bank/Brand Lane	0.6	0.6	0.6	24	17	#
HG1Saf	Off Cross Lane, Huthwaite	4.8	4.8	4.8	30	144	**
HG1Sag	Columbia St/Mill Lane, Huthwaite	1.3	1.3	1.3	30	39	*
HG1Saj	Common Road – north	1.3	1.3	1.3	30	39	*
HG1Sak	Blackwell Road/Little Lane	1.3	1.3	1.3	22	28	#
HG1Sal	Rear 211-251 Huthwaite Road	1.3	1.3	1.3	30	38	*
HG1Sam	Skegby Road, Huthwaite	0.4	0.4	0.4	30	13	#*
HG1San	King's Mill Road East	2.8	2.8	2.8	30	84	^
	TOTAL SUTTON	49.6	41.7	40.6	30	1220	

Summary	Total Site Area (Ha)	Gross Hsg Area (Ha)	Net Hsg Area (Ha)	Density (Dwgs/Ha)	Dwellings
South Notts Sub-Area					
Hucknall	91.0	63.4	58.8	35	2037
Bestwood	2.3	2.3	2.3	34	78
TOTAL	93.3	65.7	61.1	35	2115
West Notts Sub-Area					
Kirkby	45.3	29.0	29.0	32	932
Sutton	49.6	41.7	40.6	30	1220
Named Settlements	6.6	6.6	6.4	30	190
Rural Area	9.8	8.8	6.5	17	109
TOTAL	111.3	86.2	82.6	30	2451
GRAND TOTAL	204.7	152.0	143.8	32	4566

HOUSING SITE BRIEF H1

POLICY REF: **HG1 Ha**

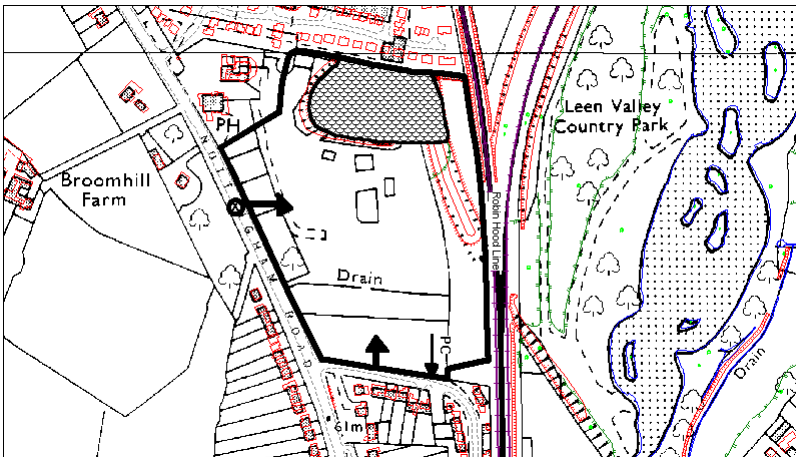

Plan reproduced from the Ordnance Survey mapping with the permission of the controller of Her Majesty's Stationery Office Crown Copyright. Unauthorised reproduction infringes on Crown Copyright and may lead to prosecution or civil proceedings

SITE NAME: **East of Nottingham Road, Hucknall**

TOTAL SITE AREA: 6.7 Ha

GROSS SITE AREA: 5.4 Ha

NET HOUSING AREA: 4.9 Ha

NET DENSITY: 34 Dwgs/Ha

DWELLINGS: 167

A. STRATEGIC/LOCATION

1. The site is bounded to the north and south by residential development, whilst the east boundary abuts the Robin Hood railway and future N.E.T. line. Located within the Public Transport Corridor, it is also close to regular bus services along Nottingham Road and to both Hucknall town centre, and Nottingham.

B. ENVIRONMENT

1. A full ecological survey will be required, including a tree/hedgerow survey, and investigations into the copse/pond area to the north of the site.
2. The copse/pond area will be retained and enhanced as an area of ecological interest.
3. Any drainage of the site to the River Leen should be carried out in a manner which protects the river's ecological sensitivity. A Sustainable Urban Drainage Systems approach should be utilised.

C. HOUSING

1. An average minimum housing net density of 34 dwellings per hectare should be achieved across the whole site.
2. An element of affordable housing will be negotiated in accordance with policy HG4.

D. TRANSPORT

1. The main site access will be off Nottingham Road, and will incorporate right turning lanes and a splitter island.
2. A joint access solution will be needed on Nottingham Road to serve both this site and site HG1Hb to the west of Nottingham Road.
3. Any vehicular access off Shelton Avenue will be limited to minor access way type road only.
4. Pedestrian and cycle access will be required through the site and linking to Shelton Avenue.

E. OPEN SPACE

1. A minimum of 10% of the gross housing area will be provided as public open space, in addition to the copse/pond area to be retained.
2. Public open space should be located adjacent to the copse/pond area.

F. SERVICES

1. Several trunk sewers cross the site and easements will be necessary.
2. Surface water should discharge to the River Leen, to the east of the Robin Hood Line.
3. Improvements to the off site sewer may be needed.

G. OTHER

1. If development is located close to the railway line, acoustic boundary treatment or sound treatment to properties may be needed
2. Contributions will be negotiated towards transport improvements in accordance with policy TR6, and improvements to educational facilities in accordance with paragraph 8.55 and policy HG1.

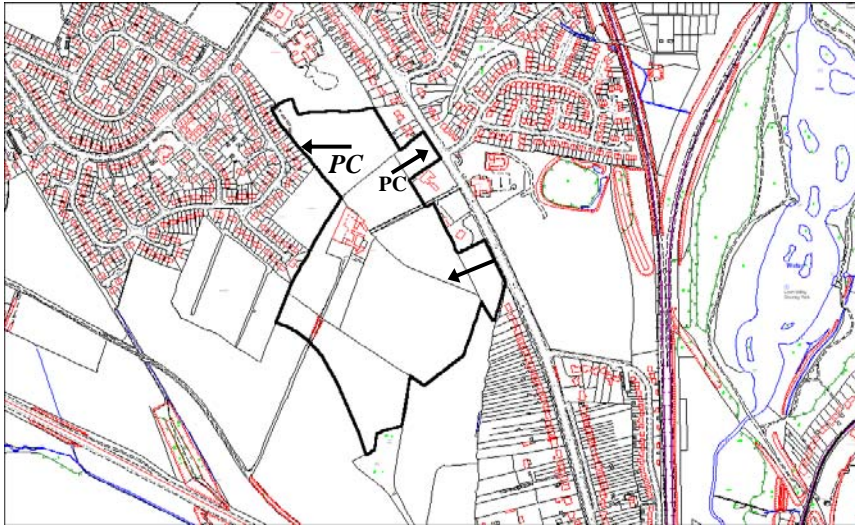
HOUSING SITE BRIEF H2POLICY REF: **HG1Hb**

Reproduced from the Ordnance Survey mapping with the permission of the controller of Her Majesty's Stationery Office Crown Copyright. Unauthorised reproduction infringes on Crown Copyright and may lead to prosecution or civil proceedings

SITE NAME: Broomhill Farm, Hucknall

TOTAL SITE AREA: 11.8 Ha

GROSS HOUSING AREA: 11.8 Ha

NET HOUSING AREA: 10.6 Ha

NET DENSITY: 34 Dwgs/Ha

DWELLINGS: 360♦

♦ The total dwelling figure may be reduced to reflect the need to ensure that development is not visible over the spur in views from the south-west.

A. STRATEGIC/LOCATION

1. The site is well located in relation to the Hucknall Public Transport Corridor, with access to N.E.T. and Robin Hood Line Stations. Regular bus services provide access to Hucknall town centre and to Nottingham. The site forms part of an agricultural holding and is bounded to the north, west and east by urban areas. A prominent ridgeline defines the south site boundary and forms the Green Belt boundary. New development whether by means of siting, design or landscaping should not be visible over the spur in views from the south-west.

B. ENVIRONMENT

1. A full ecological survey of the site and the land adjacent to the south will be needed in order to identify any protected species and trees and hedgerows worthy of protection.
2. Appropriate landscaping will be required adjacent to the south site boundary.

C. HOUSING

1. An average minimum housing net density of 34 dwellings per hectare should be achieved across the whole site.
2. An element of affordable housing will be negotiated in accordance with policy HG4.

D. TRANSPORT

1. Site access will be via the frontage gap between 136 and 156 Nottingham Road. A joint access solution will be needed to serve both this site and site HG1 Ha to the east of Nottingham Road.
2. The road system will be of a looped design, with as short a distance as possible between the loop and the Nottingham road access point.
3. A right turning lane will be provided on Nottingham Road.
4. Pedestrian/cycle routes will be provided through the site to access Nottingham Road between No. 82 & 100 Nottingham Road, and onto Lime Tree Road.

E. OPEN SPACE

1. A minimum of 10% of the gross housing area will be provided as public open space.
2. In addition to the 10% requirement above, commuted payments will be negotiated to upgrade the existing play area between the site and Lime Tree Road.

F. SERVICES

1. Two trunk sewers cross the north of the site, and these will cater for drainage of the northern half of the site. Drainage of the rest of the site will require upgrading of off-site four sewers, and surface water discharge into Farleys Brook.
2. On site balancing of surface water is likely to be required.

G. OTHER

1. Contributions will be negotiated towards transport improvements in accordance with Policy TR6, and improvements to educational facilities in accordance with paragraph 8.55 and policy HG1.

HOUSING SITE BRIEF H3

POLICY REF: HG1 Hj

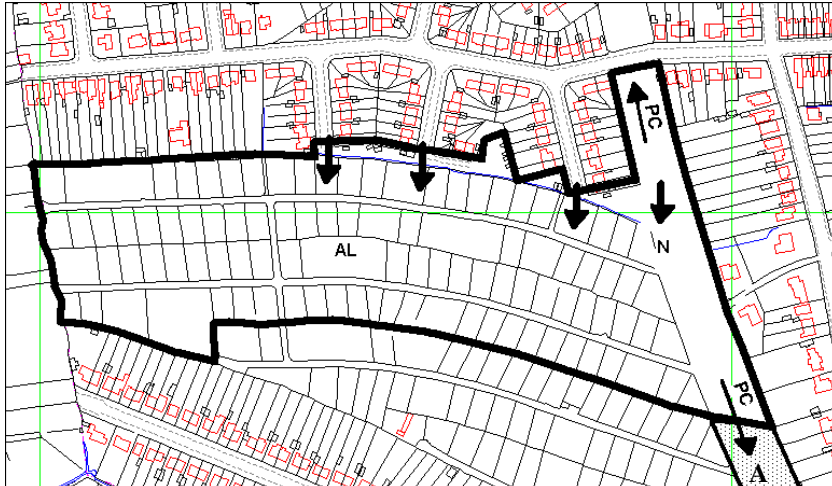

Reproduced from the Ordnance Survey mapping with the permission of the controller of Her Majesty's Stationery Office Crown Copyright. Unauthorised reproduction infringes on Crown Copyright and may lead to prosecution or civil proceedings

SITE NAME: **Garden Road, Hucknall**

TOTAL SITE AREA: 7.0Ha

GROSS HOUSING AREA: 7.0Ha

NET HOUSING AREA: 6.3Ha

NET DENSITY: 34 Dwgs/Ha

DWELLINGS: 214

A. STRATEGIC/LOCATION

1. The site comprises part of a larger area of local authority allotments, within 1km of the town centre, within the Public Transport Corridor.

B. ENVIRONMENT

1. The relocation of existing allotment holders to retained allotment areas will be required. If necessary new allotment provision will also be required to be provided on the former railway line area.
2. The hedgerow survey will be required with a view to securing any hedges worthy of retention where possible.

C. HOUSING

1. An average minimum housing net density of 34 dwellings per hectare should be achieved across the whole site.
2. An element of affordable housing will be negotiated in accordance with policy HG4.

D. TRANSPORT

1. At least two vehicular access points from those shown on the above plan will be required to serve the proposed site from Garden Road.
2. Pedestrian/cycle access shall be provided through the site and along the line of the former railway line between Garden Road and Watnall Road, and, if possible, onto Sandy Lane.

E. OPEN SPACE

1. A minimum of 10% of the gross housing area will be provided as public open space. This should include the area of the site comprising the former railway line to the east.

F. SERVICES

1. Foul drainage will be taken to the existing combined sewer on the north and east side boundaries, which may need to be upgraded.
2. Surface water drainage should be taken to soakaways if ground conditions permit, and to existing watercourses which may require upgrading.

G. OTHER

1. Contributions will be negotiated towards transport improvements in accordance with policy TR6, and improvements to educational facilities in accordance with paragraph 8.55 and policy HG1.

HOUSING SITE BRIEF H5

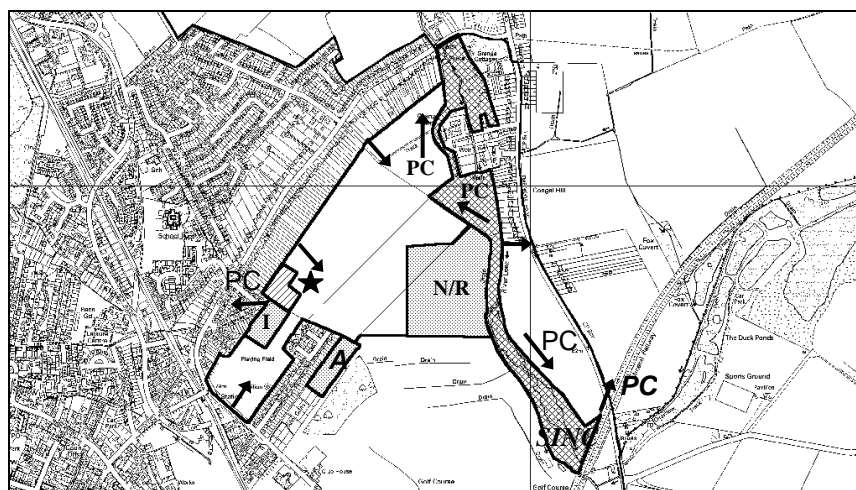
POLICY REF: **HG1 Ho**

Reproduced from the Ordnance Survey mapping with the permission of the controller of Her Majesty's Stationery Office Crown Copyright. Unauthorised reproduction infringes on Crown Copyright and may lead to prosecution or civil proceedings

SITE NAME: **South of Papplewick Lane, Hucknall**

TOTAL SITE AREA: 48.4 Ha

40 DWELLINGS/HA ZONE

GROSS HOUSING AREA:	2.2Ha
NET HOUSING AREA:	1.98Ha
DWELLINGS	79

34 DWELLINGS/HA ZONE

GROSS HOUSING AREA:	14Ha
NET HOUSING AREA:	12.6Ha
DWELLINGS	428

30 DWELLINGS/HA ZONE

GROSS HOUSING AREA:	5.9Ha
NET HOUSING AREA:	5.3Ha
DWELLINGS	159

TOTAL DWELLINGS: 666

A. STRATEGIC/LOCATION

- The site is located in close proximity to the town centre, employment sites, and is within the Hucknall Public Transport Corridor, and close to both railway and proposed NET stations. The site is bounded to the north and west by residential development, and by a former colliery spoil heap reclaimed as a golf course, and Oakenhall Avenue to the south. To the east of the site is the Leen Valley Corridor and an area of ribbon housing development fronting Moor Road.

B. ENVIRONMENT

- A full ecological survey will be required which will include the identification of protected species within and adjacent to the site, and trees and hedgerows worthy of protection.
- Any site proposals should include improvements to, and extended public access to, the Leen Valley corridor, and for an appropriate buffer zone between built development and the River Leen.
- A management scheme will be required in relation to the enhancement of the ecologically important Leen Valley area, including the land to the south east of the development site and to the west of Moor Road.

C. HOUSING

- An element of affordable housing will be negotiated in accordance with Policy HG4.
- The following average minimum housing net densities will be required, across the site:-
 - 40 dwellings per hectare within 400 metres from Hucknall Station.
 - 34 dwellings per hectare on the remaining areas of the site within 1km of the railway station.
 - A target density of 30 dwellings per hectare outside of zones (a) and (b) above.
- Safety issues need to be considered in the layout of housing directly adjacent to the golf course to the south.

D. TRANSPORT

- A detailed Transport Assessment will be required to be submitted as part of any proposal. This should include provision for a distributor road linking the three access points at Wigwam Lane and Papplewick Lane shown on the plan above. The Wigwam Lane access point will incorporate improvements to the roundabout on the Station Road junction and a new 3.5 metre footway and cycleway along the site frontage with Wigwam Lane. A four leg mini roundabout with associated traffic calming will be required at the junction of Hayden Lane and Papplewick Lane. The second Papplewick Lane junction to the West will comprise a 'T' junction. A 30 mph speed limit will be required on Papplewick Lane. Junction improvements at the Moor Road/Papplewick Lane junction will be required together with a contribution towards traffic calming in Bestwood.

- Cycleways and footways should be provided along the main distributor roads and provide appropriate links to, and along, the River Leen Corridor linking to Moor Road and Papplewick Lane. Links should also be provided to the playing fields, school site, neighbourhood centre and to Copeland Road.
- The proposals will make provision for a vehicular turning head at the end of the Oakenhall Avenue cul-de-sac.

E. OPEN SPACE

- A minimum of 10% of the gross housing area will be provided as public open space.
- Open space provision, comprising 7.5 hectares of land, to include a minimum of 5 football pitches, shall be made to the south-east and east of the development area in accordance with Policy RC4 Ha. This will replace the three existing playing fields allocated for housing purposes at Wigwam Lane. New playing pitches should be of a playable standard on this new area of open space prior to development taking place on the existing Wigwam Lane playing fields.
- Purpose built changing facilities and car/coach parking facilities shall be provided to the main area of pitch provision.
- A 1 hectare open space area should be retained on the Wigwam Lane playing fields.
- Provision should be made for potential use for additional allotment plots to the south of Oakenhall Avenue as an extension to the existing allotments, as required.
- The provision of informal open space along the River Leen Corridor should be made in accordance with the Policy RC1.
- New Formal Open Space RC4 Ha will need to accommodate balancing drainage provision to the East adjacent to the River Leen. This provision should be in accordance with the Sustainable Urban Drainage Systems approach and provide new natural areas that will act as an additional buffer to the River Leen itself.

F. SERVICES

- Surface water drainage will be to the River Leen where on site balancing may be required. This will need to be carried out to the satisfaction of the Environment Agency to ensure no adverse effect to the River Leen.

G. OTHER

- Contributions will be negotiated towards transport improvements in accordance with policy TR6 and improvements to educational facilities in accordance with paragraph 8.55 and policy HG1. The proposed site for a primary school is shown on the plan above.
- Provision will be made within the development for a small neighbourhood centre adjacent to the school to provide local facilities commensurate with the size of the site and its location close to the town centre. An indicative site location is shown on the plan above.

HOUSING SITE BRIEF H6

POLICY REF: **HG1Ka**

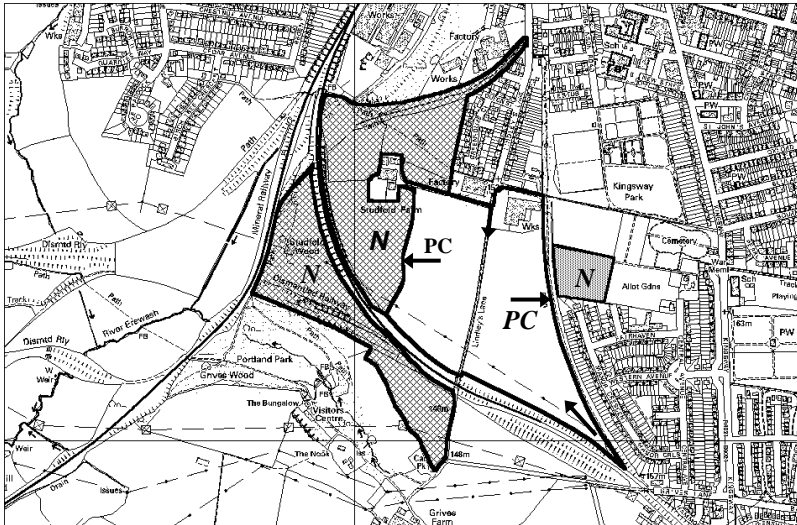

SITE NAME: **Lindley's Lane, Kirkby-in-Ashfield**

TOTAL SITE AREA: 29.7 Ha

GROSS HOUSING AREA: 13.9 Ha

NET HOUSING AREA: 13.9 Ha

NET DENSITY: n/a Dwgs/Ha

DWELLINGS: 441

Reproduced from the Ordnance Survey mapping with the permission of the controller of Her Majesty's Stationery Office Crown Copyright. Unauthorised reproduction infringes on Crown Copyright and may lead to prosecution or civil proceedings

A. STRATEGIC/LOCATION

1. This urban edge site is within 1km of the Kirkby-in-Ashfield town centre, the Robin Hood Line station and school and leisure facilities.
2. Part of the site is occupied by a general industrial use, that will need to be relocated.

B. ENVIRONMENT

1. The site is located close to important nature conservation areas, including the Portland Park and Grives SSSIs./LNR/SINC's.
2. Land adjacent to the site of nature conservation interest will require suitable future management and the transfer of these areas to an appropriate public body may be the best means to achieve this.
3. A detailed ecological assessment of the site will be required and any development scheme will be required to take account of its findings.
4. A structural tree planting buffer should be established to the south west of the housing site to minimise any adverse visual effects from the site to the areas of nature conservation value in the Portland Park area.

C. HOUSING

1. An element of affordable housing will be negotiated.
2. The final housing capacity of this site will be determined by restrictions placed on the site from access roads.

D. TRANSPORT

1. A detailed Transport Assessment will be required for this site which should include reference to the issues indicated below and any other on or off-site requirements to provide a safe and convenient means of access to this site.
2. The principal site access will be from Grives Lane with a looped road system. Secondary access will be from Lindleys Lane which is capacity constrained due to the nature of the Lane and its junction capacity with Urban Road. This secondary access should only serve the developed part of the Neville' factory to the East of Lindleys Lane, which comprised part of the Main Urban Area as defined in the 1995 adopted Local Plan, and the built curtilage of Studfold Farm.
3. Junction improvements on Kingsway and Shoulder of Mutton Hill will be required. Balls Lane may also require stopping up to prevent short cut through access.
4. Rights of way through the site to Portland Park will need to be maintained and a design solution should discourage any use by through traffic.
5. Pedestrian and cycle links will be required through the site including links to Kingsway Park to the east and the proposed area of Informal Open Space to the west of the Site.

E. OPEN SPACE

1. Commuted payments will be required to upgrade and provide open space at Kingsway Park.

F. SERVICES

1. Surface water can be discharged to the watercourse to the west of the site, although on site balancing may be needed.

G. OTHER

1. Contributions will be negotiated towards transport improvements in accordance with policy TR6 and improvements to educational facilities in accordance with paragraph 8.55 and policy HG1.

CONTENTS

	Page
PREFACE	153
INTRODUCTION	153
PARKING STANDARDS	
Part A: Class A1 – Retail Class A2 – Banks, Building Societies etc. Class A3 – Restaurants, Pubs etc.	157
Part B: Class B1 – Offices, Light Industry Class B2 – General Industry Classes B3/B7 – Special Industry Class B8 – Storage, Warehouses Mixed Use “Business Parks”	159
Part C: Class C1 – Hotels, Guest Houses etc. Class C2 – Residential School, Hospitals Class C3 – Dwellings	161
Part D: Class D1 – Surgeries, Public Halls, Places of Education Class D2 – Leisure	163
 SUI GENERIS – “Development not included in any specific Use Class”	 165
 APPENDICES	
Appendix I – Parking Standards for Town Centres	167
Appendix II – Parking Spaces for Disabled People	167
Appendix III – Layout of Car Parks	168
Appendix IV – Turning Areas in Residential Development	169
Appendix V – Appendix 2 taken from RPG8	170

NOTTINGHAMSHIRE

A GUIDE TO PARKING STANDARDS FOR NEW DEVELOPMENT

PREFACE

1. The original policy of the County Council in this respect is set out in the Nottinghamshire Structure Plan Review (1996)

“OUTSIDE NOTTINGHAM CITY CENTRE, NEW DEVELOPMENT WILL BE EXPECTED TO PROVIDE APPROPRIATE OFF-STREET PARKING WHICH SEEKS TO REDUCE THE PRESSURE FOR ON-STREET PARKING, BUT DOES NOT CONTRIBUTE TO GENERATING UNNECESSARY TRAFFIC. IN NOTTINGHAM CITY CENTRE ONLY A LIMITED AMOUNT OF PARKING PROVISION WILL BE PERMITTED BEYOND THAT REQUIRED FOR ESSENTIAL OPERATIONAL NEEDS, EXCEPT FOR SITES IN THE PEDESTRIAN PRIORITY AREAS WHERE NO PROVISION WILL BE PERMITTED.”
2. The availability of parking spaces has a major influence on the choice of means of transport and therefore, parking policies need to support the overall integration of land use and transportation. A certain level of off-street parking provision may be necessary for development to proceed, or to reduce pressure for on-street parking particularly in locations where such parking may be prejudicial to the operation of the main road network and the safety of all road users.
3. To assist prospective developers in assessing likely parking provision the County Council, in conjunction with the District Council, recommends appropriate standards for parking provision for new developments outside Nottingham City. “A Guide to Parking Standards for New Developments in Nottinghamshire” was published in November 1993, but in the context of sustainable development, it was anticipated that the standards would need to be monitored and, if necessary, revised.
4. The need for restraint of the car is now generally accepted and latest National Guidance requires Local Authorities to develop suitable policies on parking. These need to minimise the level of parking associated with the development through adoption of maximum standards in development plans and through lower provision in locations more accessible by modes other than the private car.
5. Restraint based standards are being developed to be issued as Supplementary Planning Guidance but, to be able to incorporate emerging Regional Planning Guidance, this will take time. In the meantime, the County Council has adopted INTERIM PARKING STANDARDS which the District Council has adopted. These are based on a 15% reduction of the non-operational element of non-residential uses in the 1993 standards, and are specifically aimed at trying to reduce peak hour traffic and congestion. The resultant standards are expressed as maximum levels of provision of spaces.

INTRODUCTION

6. **USE CLASSES**

So far as is possible the standards relate to the classification of land uses specified in the Town and Country Planning Use Classes Order 1987. It is recognised however that the information provided is not exhaustive nor is it possible to cover all eventualities with regard to permitted development rights within the terms of the Use Classes and General Development Orders.
7. **FLEXIBILITY**

It is not intended that the maximum provision be applied rigidly. Where circumstances dictate, for example in urban areas well served by public transport, a considerably lower level of provision should be considered.

8. **FLOORSPACE**
In most circumstances it is more appropriate to assess parking requirements on the basis of developed floorspace. All figures referred to are GROSS FLOORSPACE AREA, including circulation space, unless otherwise stated.
9. **CONSERVATION AREAS AND LISTED BUILDINGS**
Within Conservation Areas, and at all sites involving listed buildings, planning authorities will take into account the special character and nature of the surrounding area in determining the level of parking provision to be made.
10. **DUAL USE OF SPACES**
Dual use of parking spaces, whereby the provision to be made would be related to different land uses at different times of the day, is to be encouraged and should be permitted wherever practicable. This can be beneficial to development and contribute to the economic and efficient use of land.
11. **DETACHED PARKING AREAS**
Parking areas detached from the development site will be discouraged, but detached parking areas serving small scale developments may be acceptable provided they are:
- i) under the control of the developer, and satisfactory and legally binding arrangements for their continued use in connection with the development can be agreed;
 - ii) within a reasonable walking distance, are overlooked, and are safely related to the main site;
 - iii) meet normal planning requirements regarding use, access, security and other detailed layout and design criteria.
12. **SERVICING**
In all cases proper account will need to be given to the servicing arrangements for the development concerned. This will usually require the provision of on-site loading/unloading/manoeuvring/waiting space to accommodate the largest vehicle most likely to serve the development such that all vehicles can enter and leave the site in a forward gear. Manoeuvring requirements for service vehicles will be assessed by reference to accepted standards such as “TRACK” (Savoy Computing), “Designing for Deliveries” (Freight Transport Association) etc.
13. **PARKING FOR DISABLED PEOPLE**
For car parks associated with employment premises, shopping areas, leisure/ recreational facilities and other spaces open to the general public, spaces for parking by disabled people should be provided at least at the following rates:
- Up to 200 car spaces, 5% of capacity (minimum 2 spaces)
 - Over 200 car spaces, 2% of capacity plus 6 spaces.
- See Appendix II for recommendations on layout. Further advice is available in “Providing for People with a Mobility Handicap” – The Institution of Highways and Transportation.
14. **CYCLE PARKING**
For retail, commercial and industrial premises, as well as places of assembly and entertainment, it is recommended that one secure (loop type) cycle parking stand be provided for every 10 car parking spaces. A higher level of provision may be appropriate for leisure centres, student accommodation or other facilities likely to attract a high number of trips by cycle. District councils may choose to provide more specific land-use cycle parking advice relevant to the degree of cycle usage observed within their areas.
15. **MOTORCYCLES**
Significant savings in land take might be possible if separate provision is made for motorcycles as, clearly, requiring motorcycles to wait in car spaces is not an efficient use of land. Provision for motorcycle parking will be at the discretion of the District Council but should not be at the expense of more than 5% of the required car parking provision.

16. DIMENSIONS

The recommended sizes of parking spaces are:-

Private cars: the preferred bay size is 2.4m x 5.0m, or 5.5m when against a fence, wall, or other barrier. (Smaller parking bays may be acceptable in private parking areas around small residential and commercial developments).

Parking spaces for disabled persons: 5.0m x 3.6m
(Further advice on parking adjacent footways/footpaths and parking spaces for disabled people is available in The Highway Design Guide (Residential and Industrial Development – January 1999)

Commercial Vehicles: Varying from 9m x 19m x 3.1m depending upon the type of vehicle most likely to service the development.

17. DESIGN

All privately maintained parking areas should be properly laid out and designed as an integral part of the development. The parking spaces and manoeuvring areas should be adequately defined with surface materials appropriate to the surroundings of the site. Car parks should not be surfaced with loose granular materials where these could deposit onto the highway. Rather they should be hardsurfaced, sealed and independently drained within the curtilage of the site, with surface water outfalls to public sewers, not to highway drainage systems.

PARKING STANDARDS PART A

CLASS A1 – Shops, Hairdressers, Travel and Ticket Agencies, Garden Centres etc.

General/Food Retail
Staff and Customers

General Retail 500-4500m², 1 space per 20m²
Food Retail 500-4500m², 1 space per 10m²
(Note: the standard for general retail may in some circumstances only be acceptable if the developer is prepared to enter into an agreement not to undergo an otherwise permitted change to food retail).

Garden Centres
Staff and Customers
Servicing

1 space per 20m² of display and sales area
Provide 1 loading area per 1000m² with adequate waiting and manoeuvring space for the largest type of vehicle expected to be used for servicing the development.

Retail outlets not exceeding 500m² will be individually assessed.
Retail parks or stores larger than 4500m² can be considered for a reduced rate of provision but this would need to be justified on the basis of a traffic impact assessment.

CLASS A2 – Financial and Professional Services

Banks, Building Societies, Estate and Employment Agencies, Betting Offices

In all cases

Staff 1 space per 25m²
Customers 1 space per 25m²
Servicing To be individually assessed.

Small offices not exceeding 500m² will be individually assessed.

CLASS A3 – Food and Drink

Restaurants, Public Houses, Snack Bars, Cafes, Wine Bars, Hot Food Shops, Licensed Clubs

In all cases

Residential staff 1 space per 1 staff member plus 50% for their visitors
Other staff 2 spaces per 7 members of staff
Servicing 1 delivery area per unit with adequate waiting and manoeuvring space for the largest type of vehicle expected to be used for servicing the development.
Customers 1 space per 2.3m² of net public area

The following standards for customers may be applicable if the developer is prepared to enter into an agreement not to undergo an otherwise permitted change to public house, licensed club other building with a public bar:-

- i) Restaurants, Cafes -
1 car space per 4.6m² of dining area.
 - ii) Transport Cafes (intended to cater for freight drivers) –
1 lorry space (50m²) per 4.6m² of dining area
- Note: Where restaurants and cafes are intended to serve primary highway routes a more generous provision may be required subject to individual assessment.
Hot Food Takeaways up to 100m² will be individually assessed.

PARKING STANDARDS PART B

CLASS B1 – Offices, Research & Development, Light Industry

Staff		1 space per 23m ²
Servicing		
B1(a)	Offices:	1 loading area per unit
B1(b)	Research & Development	1 standing space for loading per 500m ²
B1(c)	Light Industry	1 standing space for loading per 200m ²

In all cases adequate waiting/manoeuvring space should be provided to accommodate vehicles of the largest type likely to call.

Where a developer/occupier is prepared to enter into an agreement that development is to be restricted to light industrial (and therefore not undergo a permitted change to another B1 use), then it may be acceptable to provide spaces at a rate of 1 per 30m². In practice, some sites could be conditioned so that the provided servicing space for B1(b) and (c) uses could become parking in the event of a change to B1(a).

CLASS B2 – General Industrial

i)	First 235m ²	
	Staff	1 space per 23m ²
	Servicing	1 loading area per unit with adequate waiting/manoeuvring space for vehicles of the largest type likely to call.

Where a developer/occupier is prepared to enter into an agreement that development is to be restricted to general industrial (and therefore not undergo a permitted change to a B1 use), then it may be acceptable to provide spaces at a rate of 1 per 30m².

ii)	Excess over 235m ²	
	Staff	1 space per 57m ²
	Servicing	1 standing space for loading per 200m ² with adequate waiting/manoeuvring space to accommodate vehicles of the largest type likely to call.

CLASSES B3/B7 – Special Industrial

	Staff	1 standing space per 57m ²
	Servicing	1 standing space for loading per 200m ² with adequate waiting/manoeuvring space to accommodate vehicles of the largest type likely to call.

CLASS B8 – Storage and Distribution

Warehouses, Transport Depots, Cash and Carry Direct Sales to Traders

i)	First 235m ²	
	Staff	1 space per 23 m ²
	Servicing	1 loading area per unit with adequate waiting/manoeuvring space for the largest type of vehicle likely to call

Where a developer/occupier is prepared to enter into an agreement that development is to be restricted to Class B8 use (and therefore not undergo a permitted change to a B1 use), then it may be acceptable to provide spaces at a rate of 1 per 30m².

ii) Excess over 235m²

Staff 1 space per 115m²

Servicing Buildings: 1 standing space for loading per 800m³ of building volume.
Open Space: 1 standing space for loading per 200m² of storage.
In all cases adequate waiting/manoeuvring space should be provided to accommodate vehicles of the largest type likely to call.

For Cash and Carry Use individual assessment will be required for customer parking.

For large scale developments or sites where the overnight parking of lorries can be anticipated, individual assessment of parking facilities will be required, taking account of environmental factors.

Mixed Use “Business Parks”

It is recognised that large mixed use “business parks” can vary quite substantially in traffic generation and parking requirements, depending on the precise uses to which the buildings are put. However, unless detailed information is submitted in respect of proposed land uses, parking requirements will be assessed on the basis of B1. It will also be assumed that large articulated vehicles (up to 40t) will frequent all premises for servicing requirements. If these general assumptions are to be relaxed, submissions must be accompanied by a traffic impact assessment and technical justification of the proposed parking/servicing provision using a recognised technique. Developers may then be expected to accept planning conditions controlling otherwise permitted changes of use/occupancy.

PARKING STANDARDS PART C

CLASS C1 – Hotels and Hostels (including Guest Houses)

Residential Staff	1 space per 1 staff plus 50% for their visitors
Other Staff	2 spaces per 7 staff
Resident Guests	1 space per bedroom
Dining Area	1 space per 4.6m ² if open to non-residents
Bar Area	1 space per 2.3m ² if open to non-residents
Conference Rooms	1 space per 3 seats or 1 space per 6m ² whichever is the greater if open to non-residents
Servicing	1 loading/manoeuvring area per unit with adequate waiting/manoeuvring space for the largest type of vehicle expected to be used to service the development

A reduced standard in respect of resident guest spaces may be acceptable at specialised hostels e.g. – Hostels for the Homeless.

CLASS C2 – Residential Institutions

- i) Elderly Persons' Homes, Nursing Homes and other specialised homes for those in need of care
- | | |
|----------------|--|
| Resident Staff | 1 space per 1 staff plus 50% for their visitors |
| Other Staff | 3 spaces per 7 staff |
| Visitors | 2 spaces per 11 beds |
| Servicing | Subject to individual assessment – to include turning facilities and parking for disabled people |
- ii) Hospitals
- | | |
|-------------------------------|----------------------------------|
| Staff | 4 spaces per 7 staff |
| Visitors | 4 spaces per 7 beds |
| Outpatients | 2 spaces per consulting room |
| Servicing/
Ambulances etc. | Subject to individual assessment |
- Staff parking should be provided within a reasonable distance.
- iii) Residential School, College or Training Centre
- | | |
|-----------------|---|
| Resident Staff | 1 space per 1 staff plus 50% for their visitors |
| Other Staff | 2 spaces per 7 staff |
| Other residents | To be individually assessed |
| Visitors | To be individually assessed |
| Servicing | To be individually assessed |

CLASS C3 - Dwellings

- i) General needs housing:-
- | | |
|-------------------------------|----------|
| 1-3 bedroom dwellings | 2 spaces |
| 4 or more bedroomed dwellings | 3 spaces |

In accordance with Design Bulletin 32 (1992) – “Residential Roads and Footpaths” – where small housing layouts have been specifically planned to provide parking spaces on carriageways for casual callers, these spaces may be counted towards the total provision.

- ii) Flats would normally be expected to make parking provision as above, but a relaxation may be considered acceptable where flats are provided over shops in recognised shopping areas.

- iii) Groups of flats or maisonettes (of no more than three bedrooms) may be served by privately managed communal car parks provided these are conveniently located in the proximity of the dwellings they are intended to service and they can be accessed by both visitors and residents. In these situation the minimum provision is as follows:-
- | | |
|----------------|--|
| up to 25 units | 2 spaces per dwelling |
| 25-50 units | 50 spaces + 1.5 spaces per dwelling in excess of 25 units |
| over 50 units | 88 spaces + 1.25 spaces per dwelling in excess of 50 units |
- iv) The conversion of properties for multi-occupancy residential use may be considered for a relaxation in standard where this is not likely to result in or add to significant road safety or on-street parking problems.
- v) Garages of adequate size may be counted as single assigned parking spaces but should always be provided with a minimum 5.5m long hardstanding clear of the highway.
- vi) Sheltered housing (i.e. units specifically designed for people requiring a degree of care provided by on-site warden(s)).
- | | |
|--------------------|---|
| Resident Warden(s) | 1 space per 1 warden + 50% for their visitors |
| Other Staff | 1 space per 1 staff |
| Visitors | 1 space per 2 units |
- Some parking spaces may need to be a minimum 3.6m wide to accommodate wheel chairs.
- vii) “Active elderly” persons’ housing, (i.e. housing designed for older people, but not requiring care) will be treated as normal residential development for parking purposes. However, a relaxation in standard may be acceptable for developments covered by an appropriate legal agreement in respect of occupancy.
- viii) Student Halls of Residence
- | | |
|-----------------------|-----------------------------|
| Resident Staff | To be individually assessed |
| Students in residence | 1 space per 2-4 students |
- Use of the lower end of the range may be appropriate where halls are within easy access of the relevant educational premises and a generous provision is made for cycle parking (at least one cycle stand per two students), or are well served by public transport. Care will need to be taken so that any under-provision of parking spaces would not cause local problems.
- ix) Relaxation in residential parking standards may be considered for special needs housing.
- x) Where access is permitted to individual dwellings from classified or other busy roads turning facilities within the site curtilage will normally be required independent of the parking spaces (see appendix IV).

**PARKING STANDARDS
PART D**

CLASS D1 – Non-Residential Institutions

- i) Doctors Surgeries, Health Centres, Clinics, Dentists, Physiotherapists, Veterinary Surgeons
Professional and other staff 1 space per member of staff
Patients 3 spaces per 2 consulting rooms
- ii) Public Halls (including galleries, museums, libraries, places of worship)
Staff To be individually assessed
Visitors 1 space per 5 seats or 1 space per 30m² of public area
 whichever is the greater
- A reduced standard may be acceptable for specific community uses such as youth clubs, Scout and Guide Headquarters etc., depending on size and catchment area. However, it may then be necessary to impose conditions preventing changes of use within the Use Class.
- iii) Places of Education
- a) Infant/Junior/Secondary Schools
Staff 1 space per member of staff
Visitor Parking 2 spaces per 9 members of teaching staff
Servicing A minimum of 50m² for deliveries
Buses 1 space for bus/school minibus etc. per 1000 pupils
Hard surfaced play areas should be accessible to vehicles so that they can be made available for parents parking on Open Days etc.
Depending on age group, catchment area and local traffic/environment conditions the following requirements will be individually assessed:-
- 1) Space within the site (preferably as part of a one-way system) for contract buses to set down and pick up children.
 - 2) Where schools are accessed directly from a classified or busy road, space within the school grounds for parents' vehicles (setting down/picking up) or provision of lay-by within the adjacent highway.
- Student parking should be in accordance with further education establishments, where schools are used for evening classes.
- b) Tertiary, Adult Education etc.
Staff 1 space per staff member
Students and Visitors 1 space per 3 students
Servicing A minimum of 50m² for deliveries
- c) Nurseries, playgroups, crèches (including those within private dwellings)
Staff 1 space per staff member
Parents 1 space per 6 children for picking up/setting down
The requirements for parents parking may be relaxed depending on the nature of the adjoining roads. However, for premises fronting classified and other busy roads full provision with independent turning facilities clear of the highway will normally be required.
- d) Day Centres
Staff 1 space per staff member
Special provision will need to be made for the parking, waiting and manoeuvring of minibus/ambulances etc. used for the transport of the elderly or other persons in need of care.

CLASS D2 – Assembly and Leisure

- i) Cinemas, Bingo Halls, Dance Halls, Concert Halls
Staff To be individually assessed
Customers 1 space per 3 seats or
 1 space per 10m², whichever is the greater

Performers 1 space per 10m² dressing room space
 Space should be provided within the site or close to the main entrance to the building for at least two cars or a coach to set down and pick up patrons.

ii) Swimming Pools

Staff To be individually assessed
 Participants 1 per 10m² pool area

Separate provision may need to be made for spectators if public car parks are not located nearby. A layby or other setting down place close to the main entrance to the building for at least 2 cars or a coach may be necessary if the pools are used by schools and other organised groups. Additional provision may be necessary where saunas, jacuzzi, fitness centres etc. are also provided, to be individually assessed.

iii) Playing fields, sports facilities and leisure centres

Staff To be individually assessed
 Players 1 space per 2 players maximum possible at any one time
 Spectators To be individually assessed

Parking spaces for players should take into account the possible overlap that may occur during “changeover” times. Separate provision may be needed for coaches, particularly at major sporting venues, to be individually assessed.

Parking facilities for major sporting venues may be located some distance from the development in association with other public/private parking areas subject to satisfactory legal agreements to secure long-term use.

iv) Marinas, Sailing Clubs and Other Water Sports

Resident Staff To be individually assessed
 Other Staff to be individually assessed
 Participants 1 space per mooring berth. Other water facilities to be individually assessed

v) Golf Courses

Staff/Players To be individually assessed

vi) Public Open Space, Country Parks

In all cases 4 spaces per hectare
 but “theme parks” etc. offering a range of family entertainments would need to be individually assessed.

Note: Additional Facilities

Where additional facilities are provided for any of the above recreational uses (e.g. restaurants, bars, etc.) and it is intended that these should be made available to the general public, as opposed to club members only, additional parking provision would normally be required in accordance with the appropriate standard.

PARKING STANDARDS – SUI GENERIS

“Development not included in any specific Use Class”

- | | | |
|------|--|---|
| a) | Garages/Motor Trade
Staff - | 1 space per employee |
| | and in addition:- | |
| i) | Car/Lorry Sales
Customers | 1 space per 5 vehicles displayed for sale with a minimum of 2 spaces, customer spaces to be clearly marked |
| | plus | 1 lorry unloading/manoeuvring space, i.e. vehicle transporters |
| ii) | Car/Lorry Auction
Customers - | 1 space per every 5 vehicles stored or 1 space per 15m ² display and vehicles storage area, whichever is the greater |
| iii) | Service/Repairs
Cars - | 1 space per 10m ² service/repair area or 4 spaces per service/repair bay whichever is the greater |
| | Lorries – for commercial
vehicle stations | 4 spaces of 45m ² per service/repair bay
4 spaces of 45m ² per recovery vehicle |
| iv) | Spare Parts
Customers - | 1 space per 20m ² of sales counter and stock rooms |
| | For tyre/exhaust premises a higher provision may be required. | |
| v) | Car Hire
Hire Vehicles - | 1 space per 2 vehicles |
| | Customers - | 1 space per 10 hire vehicles, with a minimum of 2 spaces |
| vi) | Automatic Car Wash
Customers - | minimum 5 waiting spaces |
| b) | Driving Schools
Staff - | 1 space per office based employee |
| | Operational - | 1 space per vehicle |
| c) | Taxi Offices/Private Hire Bases
Staff - | 1 space per office based employee |
| | Operational - | 1 space per vehicle |
| | Where premises do not afford adequate parking provision, the use may be acceptable provided the vehicles are operated remote from the premises which acts purely as a communication centre. In such circumstances planning permission might be appropriate on a temporary renewable basis. | |
| d) | Petrol Filling Stations
Staff - | 1 space per employee plus sufficient space to enable a fuel tanker to enter and leave in a forward gear |
| e) | Theatres
Staff - | To be individually assessed |
| | Customers - | 1 space per 3 seats or 1 space per 10m ² floor space whichever is the greater |
| | Performers - | 1 space per 10m ² of dressing room |
| | Space should also be provided within the site or close to the main entrance to the building for a minimum of two cars or a coach to set down/pick up patrons. | |

- f) **Open Markets and Car Boot Sales**
Open Markets in established district centres will not normally require parking provision for customers. However, space should be made available for traders' vehicles at a rate of 1.5 spaces per stall. Stalls should be laid out to provide easy access for vehicles to load and off-load clear of the highway.
Only sites in excess of 5000m² are likely to be suitable for car boot sales and where planning permission is required normally highway standards in respect of access will be applied. Also it is recommended that no more than half the site area be given over to the vehicles with goods for sale. The remainder of the site should be laid out for customer parking.

APPENDICES

i) SUGGESTED CAR PARKING STANDARDS FOR TOWN CENTRES, WHERE THERE IS A SPECIFIC POLICY TO REDUCE CARE ACCESS

A1	Shops)	one space per
A2	Financial & professional services)	25m ² of gross
A3	Food and drink)	Floorspace
B1	Offices)	One space per 100m ²
B1	Light Industry)	of gross floorspace
B2	General Industry)	one space per 400m ²
B8	Storage & Distribution)	of gross floorspace
C1	Hotels)	one space per bedroom (if a hotel provides conference facilities, the number of parking spaces required must be assessed individually)
C3	Residential)	one space per dwelling

Other uses: Parking standards would remain as in the main part of the document.

COMMUTED PAYMENTS

Where approved parking standards cannot be met or should not be met because of other policies then planning permission may be dependent on the applicant entering into a legal agreement to contribute commuted payments in lieu.

Commuted payments are not expected to be required for developments of less than 500 sq.m. of gross floorspace.

ii) PARKING SPACES FOR DISABLED PEOPLE

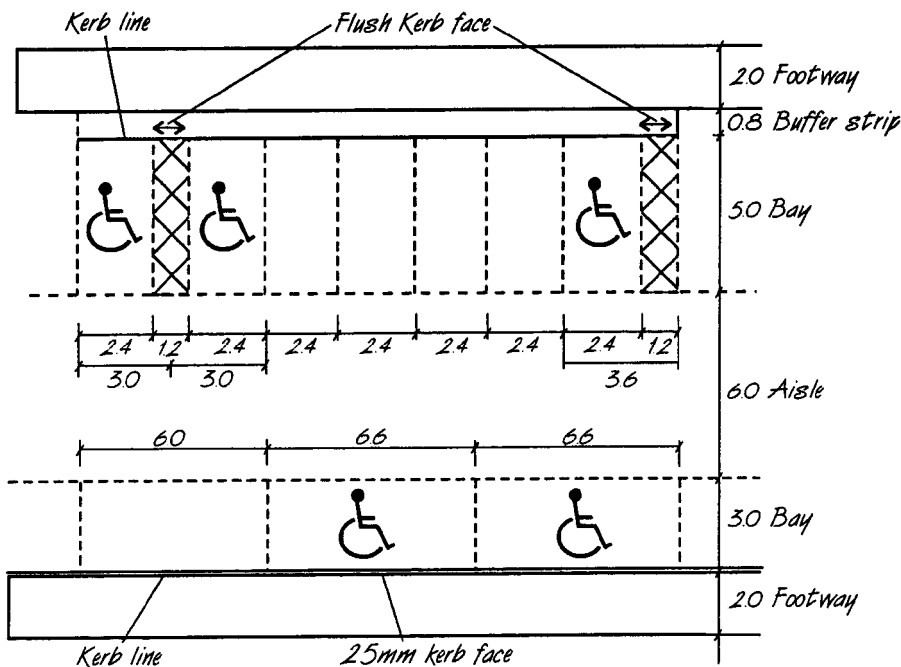

CAR PARKING

In all developments parking provision should be made for the special needs user. (See Introduction – para. 13).

Designated spaces should be clearly marked and should be signposted at the entrance to the parking area.

Designated spaces should be located as close as possible to the principal building entrance.

Use of the spaces must be carefully monitored to ensure that they are always available to the special needs user.

iii) **LAYOUT OF CAR PARKS**

The actual layout and circulation system to be adopted for a particular car park depends upon the size and shape of the area available. However, the following dimensions are useful in determining the layout and capacity of a car park.

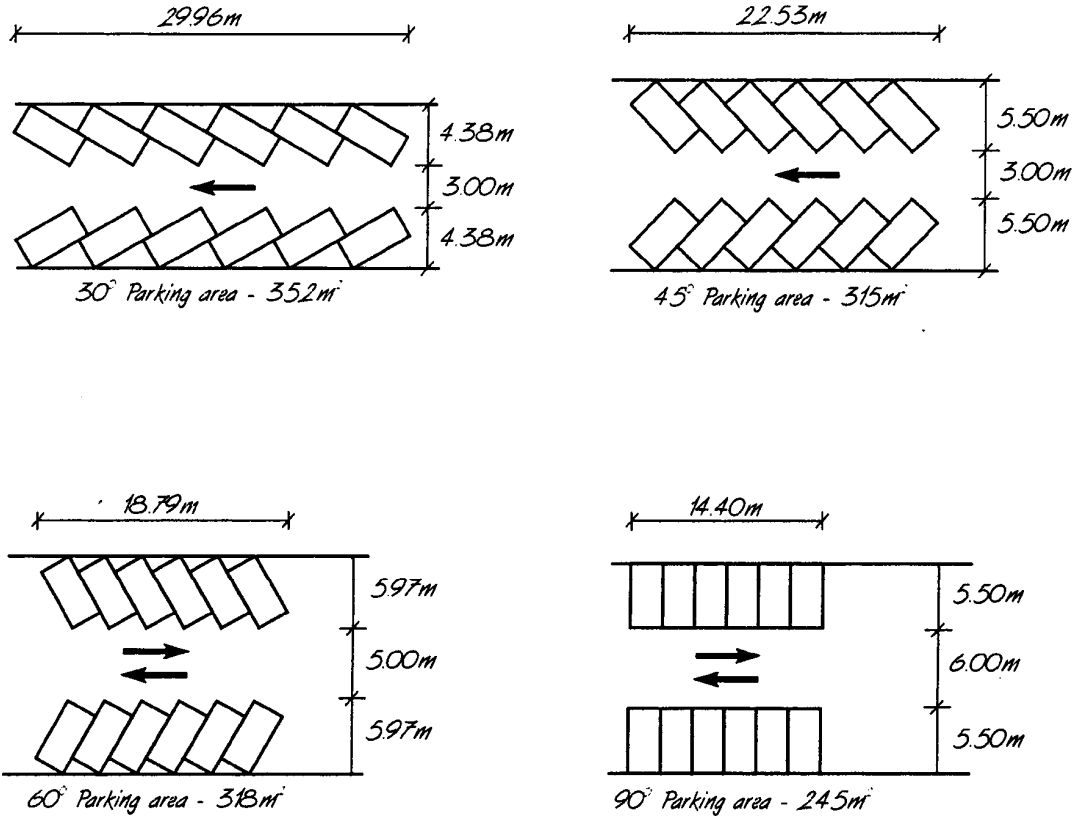

LAYOUT OF PARKING AREAS FOR 12 SPACES OF 5.5m x 2.4m

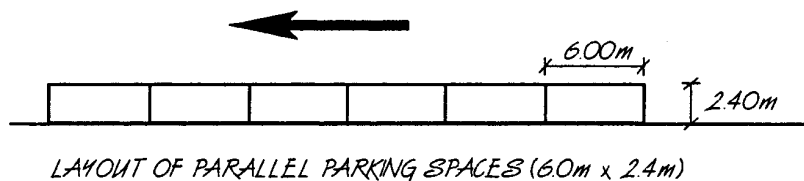

Parking at right angles to the aisle (90° parking) usually makes the most efficient use of space. However, where the shape of a car park does not lend itself to this standard type of layout it may be more appropriate to adopt angled parking systems. It is preferable with this type of layout that circulation aisles be one-way, and with angled parking at 45° or less it is essential that they be one-way, aisles for normal 90° parking should be 6 metres wide. This width can be reduced to 3 metres for angled parking with one-way systems.

iv) TURNING AREA IN RESIDENTIAL DEVELOPMENT

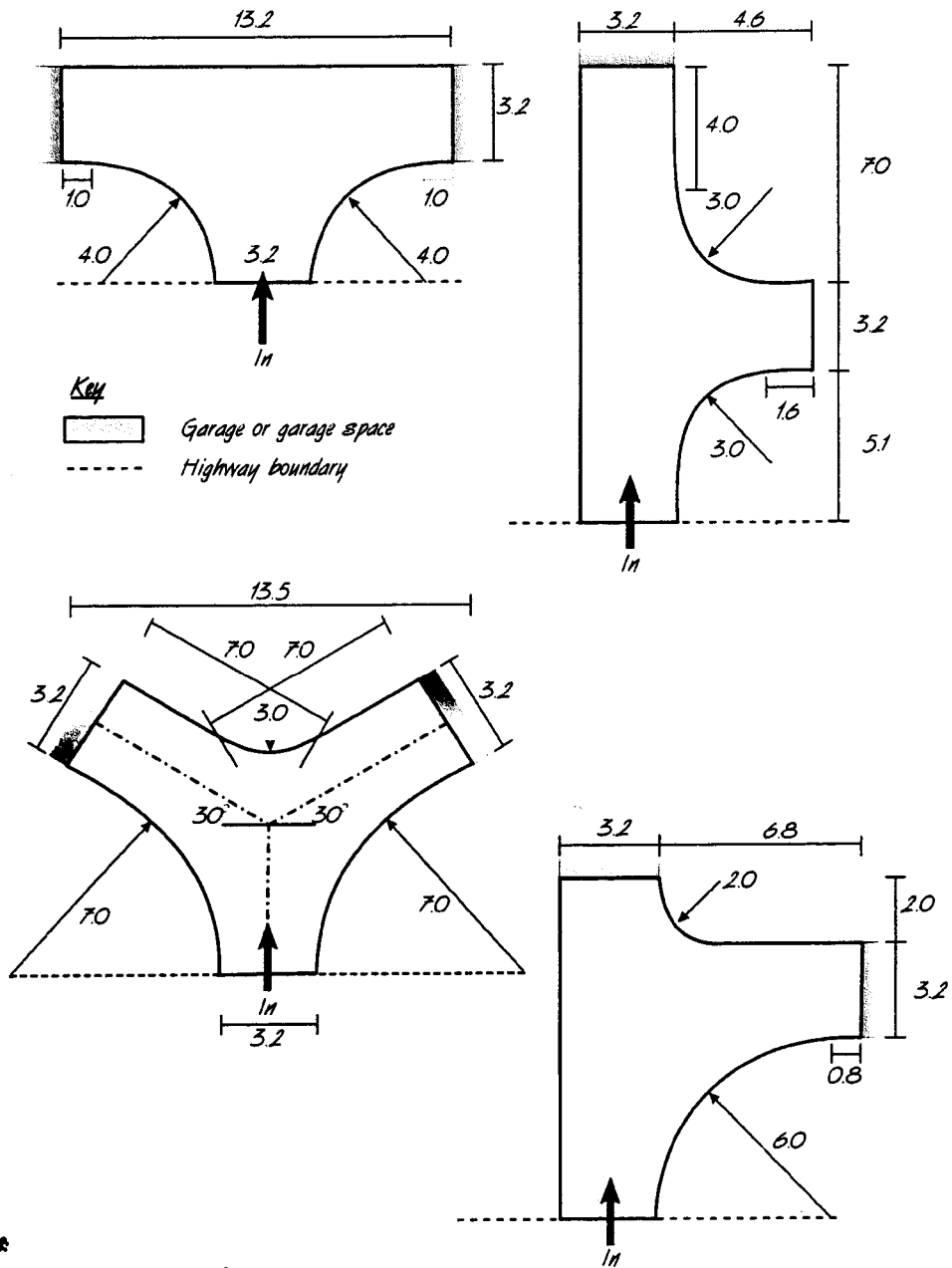

Note

All dimensions are in metres

Dimensions shown are also the minimum requirements for car only turning within a cul-de-sac.

1. In certain circumstances it may be necessary to make provision within the curtilage of a dwelling for a car to be turned so that it does not have to reverse within the highway. The minimum dimensions for such a domestic turning area are shown above. Note: The turning area is in addition to normal parking space requirements.
2. Driveway should be wide enough to allow access to both sides of the parked car and also, on one side, allow for a pathway to the house. Normally 3.2m wide, but may be acceptable to reduce the width (3m with access to both sides of the car or 2.6m with access to one side only) where the driveway does not have to provide a pathway to the house.

APPENDIX 2 (TAKEN FROM RPG8)

Parking Provisions for New Development

INTRODUCTION

Existing national planning policy guidance stresses the need for land-use planning policies, which reduce the need for travel. However, if such policies are to succeed, they need to be supported by other measures such as transport. In particular, the availability of car parking has a major influence on the choice of means of travel and therefore, appropriate car parking policies are necessary.

For new developments, PPG13 suggests that maximum levels of car parking provision should be set for broad land-use classes and locations, but it is unlikely to be appropriate in future for development to be provided with as many car parking spaces as there are employees. In this way, reduced levels of parking will act as a demand management tool as part of package of measures designed to influence and encourage more sustainable travel behaviour. PPG13 also states that strategic policies on parking should be included in Regional Planning Guidance and Structure Plans to avoid the destructive potential for competitive provision of parking by neighbouring authorities.

REGIONAL CONTEXT

As a first step in following the advice of PPG13, the University of Westminster was commissioned to undertake a study (the East Midlands Joint Car Parking Study) of the three conurbations of Derby, Leicester and Nottingham. The main aim of the study was to investigate the use and need for parking at various types of development. One of the conclusions of the study was that, in general, existing parking provision, particularly for employment uses, was generous.

As highlighted by the Transport White Paper, employees driving to work and enjoying free parking at their workplace account for a significant proportion of peak hour congestion. Therefore, an important contribution to reducing traffic growth/congestion can be made if local authorities use their development control powers to limit the amount of parking associated with new business premises. With this in mind, a regional working group used the results of the study as a basis for determining a regional approach to producing new restraint-based maximum levels of car parking provision for new employment development.

METHODOLOGY

The methodology for deriving the standards for the larger employment developments is set out below. It relates parking provision directly to the number of employees and has five key elements:

(i) Area Differences.

There are distinct differences between the characteristics of the cities compared to the towns in the conurbations, and also compared to the free standing rural towns, in particular in relation to opportunities for using alternative modes to the private car. As a result, consideration has been given to different levels of maximum parking provision for city, urban and rural situations. For clarification 'Urban' towns are defined as shown in Table A. The 'cities' in Table B are defined for these purposes as Derby, Leicester, Northampton and Nottingham.

(ii) Definition of Location.

Use has been made of established terminology from PPG6, e.g. town centre, out-of-town, etc.

(iii) Estimate of Number of Employees.

Existing employee density data for each of the three broad employment uses (B1 Office, B2 General Industry/B1 Non-Office, and B8 Warehousing) indicates the following square metre / employee:

	<i>Out of City Centre</i>	<i>Urban Town</i>	<i>Rural Town</i>	<i>Out of Town</i>
B1	14	16	16	16
B2	30	35	35	35
B8	78	78	78	78

(iv) Targets for Employees Driving to Work.

Based on reducing existing levels of employees driving to work in line with expectations of local transport plans and likely opportunities to transfer to alternative modes, targets for employees driving to work have been set as follows:

	<i>City</i>	<i>Urban Town</i>	<i>Rural Town</i>
City/Town Centre	Nil	30%	40%
Out of City Centre	40%	n/a	n/a
Rest of Town	n/a	50%	55%
Out of Town/City	65%	65%	65%

(v) Utilisation Factor

Research indicates that in some circumstances all employees driving to work do not necessarily use spaces provided for them. This suggests the following utilisation factors:

	<i>City</i>	<i>Urban Town</i>	<i>Rural Town</i>
City/Town Centre	n/a	90%	100%
Rest of Town/City	35-90%	90%	100%
Out of Town/City	100%	100%	100%

The combined effects of employee density, targets for employees driving to work and utilisation factors have been used to help derive the maximum levels of parking provision for different

areas/locations for the three broad categories of employment development as shown in Table B.

OTHER DEVELOPMENTS

The proposed maximum parking standards for other development uses shown in Table C, have been derived from PPG13.

DEVELOPMENT BELOW THRESHOLDS

PPG13, paragraph 53, states that for a smaller scale development below the relevant threshold, local authorities should use their discretion in setting the levels of parking appropriate for small developments so as to reflect local circumstances. This approach should not undermine efforts to keep parking levels for new development, generally below the maximum levels set out in Table B.

RESIDENTIAL DEVELOPMENT

Local authorities should include in their development plans parking standards that take account of the advice in paragraphs 59 to 62 of PPG3. This says that car parking standards that result, on average, in development with more than 1.5 off street car parking spaces per dwelling are unlikely to reflect the Government's emphasis on securing sustainable residential environments.

FUTURE STEPS

The proposed maximum levels of parking provision represent a significant degree of restraint in locations such as city/town centres where accessibility to public transport is good, but have less of a restraining effect in other locations, such as rural areas, where there are currently less opportunities to consider alternative modes to the car. They are seen as a first stage in an evolving process, as the effects of measures proposed in local transport plans begin to take effect. The methodology for employment development permits further restraint to be applied by simply revising the targets for employees driving to work.

Table A: 'Urban' Towns

<i>Derbyshire</i>	<i>Derbyshire</i>	<i>Lincolnshire</i>	<i>Northamptonshire</i>	<i>Nottinghamshire</i>	<i>Rutland</i>
Borrowash	Oadby/Wigston	Lincoln	Kettering	Arnold	(none)
Brimington	Earl Shilton/		Wellingborough	Beeston	
Chesterfield	Barwell		Corby	Carlton	
Ilkeston	Hinckley/Burbage		Daventry	Hucknall	
Long Eaton	Loughborough/		Rushden	Stapleford	
Sandiacre	Shepshed		Brackley	West Bridgford	
Staveley			Towcester	Eastwood	
				Kimberley	
				Mansfield	
				Mansfield	
				Woodhouse	
				Warsop	
				Sutton-in	
				Ashfield	
				Kirkby-in	
				Ashfield	

Note: The Transport Group of the RPB undertook the classification of towns as urban

Table B: Proposed Maximum Parking Provision**New Employment Use (Above 2,500 m² gross floor space)**

<i>B1: Office Use</i>	<i>Cities</i>	<i>Urban Towns</i>	<i>Rural Towns</i>
Town Centre/Edge of Centre	1/100m ²	1/60m ²	1/40m ²
Rest of Town	1/40m ²	1/35m ²	1/30m ²
Out of Town	1/30m ²	1/30m ²	1/30m ²
<i>B2: General Industry/B1 non-office</i>			
Town Centre/Edge of Centre	1/215m ²	1/130m ²	1/90m ²
Rest of Town	1/85m ²	1/80m ²	1/65m ²
Out of Town	1/55m ²	1/55m ²	1/55m ²
<i>B8: Warehousing</i>			
Town Centre/Edge of Centre	1/450m ²	1/300m ²	1/200m ²
Rest of Town	1/215m ²	1/180m ²	1/150m ²
Out of Town	1/120m ²	1/120m ²	1/120m ²

Table C: Other Development Uses

<i>Use</i>	<i>Maximum Parking Provision 1 space per square metre (m²) of gross floorspace unless otherwise stated</i>	<i>Threshold Above Which Standard Applies (gross floorspace)</i>
Food Retail	1 Space per 14 m ²	1,000m ²
Non Food Retail	1 Space per 20 m ²	1,000m ²
Cinemas and Conference Facilities	1 Space per 5 seats	1,000m ²
D2 (other than cinemas, conference facilities and stadia)	1 Space per 22 m ²	1,000m ²
Higher and Further Education	1 space per 2 staff + space per 15 students (see note 1)	12,500m ²
Stadia	1 space per 15 seats (see note 2)	1,500 seats

Notes:

1. The guideline for students relates to the total number of students attending an educational establishment, rather than full-time equivalent figures.
2. For stadia, sufficient coach parking should be provided to the satisfaction of the local authority and treated separately from car parking. Coach parking should be designed and managed so that it will not be used for car parking.
3. Parking for the disabled should be additional to the guideline. Development proposals should provide adequate parking for disabled motorists, in terms of numbers and design (see Traffic Advice Leaflet 5/95, Parking for Disabled People).
4. For mixed-use development, the gross floorspace given over to each use should be used to calculate the overall total maximum parking figure.

SPECIAL DEVELOPMENT SITE BRIEF S1

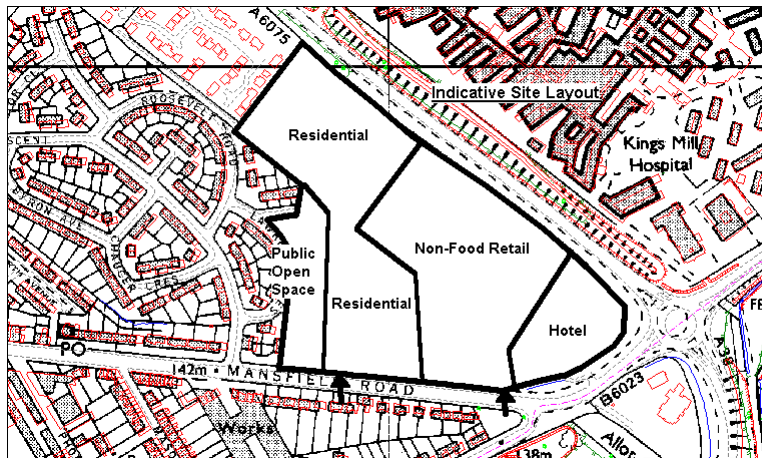
POLICY REF: **SH 10**

SITE NAME: **Kingsmill Road, East/
Mansfield Road, Sutton-
in-Ashfield**

NON FOOD
RETAIL: 3.9 Ha

HOUSING: 2.8 Ha

ROAD
RELATED/
HOTEL: 0.8 Ha

OPEN SPACE 1.2 Ha

Plan reproduced from the Ordnance Survey mapping with the permission of the controller of Her Majesty's Stationery Office © Crown Copyright. Unauthorised reproduction infringes on Crown Copyright and may lead to prosecution or civil proceedings.

A. STRATEGIC/LOCATION

1. The site lies within the urban area of Sutton-in-Ashfield and occupies a key location in respect of the strategic highway network, public transport, cycleways and footpaths.

B. ENVIRONMENT

1. The site does not contain any protected nature conservation or landscape features.
2. Mature trees adjacent to Mansfield Road should be retained.

C. PROPOSED USES

1. This site is suitable for a comprehensive development of non food retail for bulky goods only for a single user where suitable alternatives are not available, housing, open space and road related uses including hotel and potentially restaurant facilities.

D. TRANSPORT

1. A transport assessment will be required for this site which should include reference to any on or off site requirements.
2. The site access will be from Mansfield Road and there should be no direct vehicular access to the A6075.

E. OPEN SPACE

1. The site partly comprises land formerly used as a running track by Sutton Harriers and land occupied by CV. Apparel Ltd. for Sports and Social Club activities.
2. A comprehensive approach to developing this site will require the relocation of the existing sports and social club and associated pitches and alternative provision for the athletics club comprising an all weather surface track and associated facilities.
3. A 1.2 hectare area of open space will also be retained as part of the comprehensive development to the western site boundary off Lawrence Crescent.
4. A landscaped open space buffer will be required adjacent to Kings Mill Road East.
5. A commuted sum will be required for the provision and improvement of open space.